

SP-II LOWER HILL PLANNED DEVELOPMENT DISTRICT  
PRELIMINARY LAND DEVELOPMENT PLAN

Pittsburgh, Pennsylvania

URBAN DESIGN ASSOCIATES

LaQuatra Bonci Associates



SEPTEMBER 2014





# Acknowledgements

**PROPERTY OWNER**

Sports and Exhibition Authority of Pittsburgh and Allegheny County (SEA),  
Urban Redevelopment Authority of Pittsburgh (URA)

**APPLICANTS**

Pittsburgh Arena Real Estate Redevelopment, LP (as Option holder),  
Sports and Exhibition Authority of Pittsburgh and Allegheny County (SEA),

**CONSULTANT TEAM**

Urban Design Associates  
LaQuatra Bonci Associates  
Trans Associates

**LEGAL & DEVELOPMENT CONSULTANTS**

Reed Smith LLP  
Jones Lang LaSalle  
Dunham reGroup

**SUSTAINABILITY SUB GROUP COMMITTEES:**

**ENERGY**

Donald Carter  
*Chairperson*  
*Urban Design Associates*

**MATERIALS AND SUPPLY CHAIN**

Ryan Yurcaba  
*Chairperson*  
*Urban Design Associates*

**TRANSPORTATION**

Cindy Jampole  
*Chairperson*  
*Trans Associates*

**WATER**

Fred Bonci  
*Chairperson*  
*LaQuatra Bonci Associates*

**SUSTAINABILITY SUB GROUP PARTICIPANTS:**

Nina Baird  
*Carnegie Mellon University*

Michael Barnard  
*Oxford Development*

Lucinda Beattie  
*Pittsburgh Downtown Partnership*

Dr. Eric Beckman  
*Mascaro Center for Sustainable Innovation*

Stephen Bland  
*Port Authority of Allegheny County*

Beth Dutton  
*3 Rivers Wet Weather*

Joseph Fedor  
*ALCOSAN*

Bill Ferguson  
*Pittsburgh Parks Conservancy*

Karen Fitch  
*Office of Councilman Lavelle*

Janie French  
*The Pennsylvania Environmental Council*

Mike Gable  
*Department of Public Works*

Tom Gigliotti  
*Pittsburgh Water & Sewer Authority*

Aftyn Giles  
*City of Pittsburgh*

Rudy Gorny  
*Bayer Material Science*

David Hance  
*Perkins Eastman*

Pat Hassett  
*Department of Public Works*

Henry Johnstone  
*GLHN Architects & Engineers*

Khee Poh Lam  
*Carnegie Mellon University*

Matthew Mehalik  
*Sustainable Pittsburgh*

Larry Odille  
*Pittsburgh Water & Sewer Authority*

Jan Oliver  
*ALCOSAN*

David Onorato  
*Pittsburgh Parking Authority*

Stephen Patchan  
*Department of City Planning*

Paul Platte  
*Bayer Material Science*

Amanda Purcell  
*Department of Public Works*

Susan Rademacher  
*Pittsburgh Parks Conservancy*

Cate Rassman  
*Department of City Planning*

Kate Rakus  
*Department of City Planning*

Laxmi Rao  
*International District Energy Association*

Bill Recker  
*Pittsburgh Gateways*

Patrick Roberts  
*Department of City Planning*

Chuck Rompala  
*Port Authority of Allegheny County*

Tom Ryser  
*Sports & Exhibition Authority (consultant)*

John Schombert  
*Three Rivers Wet Weather*

Dan Sentz  
*Department of City Planning*

Shaun Seydor  
*Institute for Entrepreneurial Excellence*

Aurora Sharrard  
*Green Building Alliance*

James Sloss  
*City of Pittsburgh*

Wendy Stern  
*Port Authority of Allegheny County*

James Stitt  
*Pittsburgh Water & Sewer Authority*

Tim Thiel  
*Bayer Material Science*

Robert Thornton  
*International District Energy Association*

Alan Traugott  
*CJL Engineering*

Lisa Kunst Vavro  
*The Penn State Center*

Don Waldorf  
*Pittsburgh Water & Sewer Authority*

Eddie Yongo  
*Pittsburgh Gateways*

Rob Zaharchak  
*Green Building Alliance*

Jeaneen Zappa  
*Allegheny County*

# Table of Contents

SECTION 1. INTRODUCTION	1	SECTION 4. BUILDING TYPES	54	SECTION 9. TRANSIT AND PEDESTRIAN IMPROVEMENTS	91
Sec. 1.1 Purpose	2	Sec. 4.1 Introduction	55	Sec. 9.1 Introduction	92
Sec. 1.2 Organization of the Document	3	Sec. 4.2 General Regulations	56	Sec. 9.2 Pride Street	93
Sec. 1.3 Overview and Planning History	4	Sec. 4.3 Building Materials and Systems	57	Sec. 9.3 Intersection Pedestrian Amenities	94
Sec. 1.4 A Sustainable Community	5	Sec. 4.4 Building Elements	58	Sec. 9.4 Traffic Signalization	95
Sec. 1.5 Legacy and Placemaking	6	Sec. 4.5 Type I Buildings	59		
		Sec. 4.6 Type II Building	60	<b>INTENT &amp; IMPLEMENTATION: SECTION 10–12</b>	
<b>REGULATORY STANDARDS: SECTION 2–5</b>		Sec. 4.7 Type III Building	61	SECTION 10. ILLUSTRATIVE MASTER PLAN	98
SECTION 2. REGULATING PLANS	7	SECTION 5. SIGNAGE REGULATIONS	62	Sec. 10.1 Introduction	99
Sec. 2.1 Introduction	8	Sec. 5.1 Introduction	63	Sec. 10.2 Illustrative Block A	101
Sec. 2.2 The Specially Planned District	9	Sec. 5.2 District Regulations	64	Sec. 10.3 Illustrative Block B	102
Sec. 2.3 Sustainability Requirements and Strategies	10	Sec. 5.3 Signage Guidelines	66	Sec. 10.4 Illustrative Block C	103
Sec. 2.4 Blocks	15			Sec. 10.5 Illustrative Block D	104
Sec. 2.5 Streets and Pedestrian Connections	16	<b>DEVELOPMENT GUIDELINES: SECTIONS 6–9</b>		Sec. 10.6 Illustrative Block E	105
Sec. 2.6 Open Space and Courtyards	17	SECTION 6. SUPPLEMENTAL GUIDELINES	68	Sec. 10.7 Illustrative Block F	106
Sec. 2.7 Street Frontages	19	Sec. 6.1 Introduction	69	Sec. 10.8 Illustrative Block G	107
Sec. 2.8 Building Height and View Corridor	28	Sec. 6.2 Sidewalk Cafes	70	Sec. 10.9 Illustrative Block H	108
Sec. 2.9 Parking and Service	31	Sec. 6.3 Lighting	71	Sec. 10.10 Multi-User Parking Application	109
Sec. 2.10 Sub District 3	35	Sec. 6.4 Materials	72	SECTION 11. IMPLEMENTATION PROGRAM	110
SECTION 3. STREET TYPES	37	Sec. 6.5 Site Furnishings	73	Sec. 11.1 Implementation Program	111
Sec. 3.1 Introduction	38	SECTION 7. OPEN SPACE, PUBLIC ART, AND LANDSCAPE GUIDELINES	76		
Sec. 3.2 Street Type A	39	Sec. 7.1 Introduction	77	SECTION 12. DEFINITIONS	113
Sec. 3.3 Street Type B	40	Sec. 7.2 Urban Open Space Plan	78	Sec. 12.1 Definitions	114
Sec. 3.4 Street Type C	41	Sec. 7.3 Public Art Plan	82		
Sec. 3.5 Street Type D	42	Sec. 7.4 Plant Palette	83		
Sec. 3.6 Street Type E	43	Sec. 7.5 Plant Palette Streetscapes	84		
Sec. 3.7 Street Type F	44	SECTION 8. SYSTEMS AND NETWORKS INTEGRATION	85		
Sec. 3.8 Street Type G	45	Sec. 8.1 Introduction	86		
Sec. 3.9 Sidewalk Types A, B, and C	46	Sec. 8.2 Energy District and Private Utility Systems Integration	87		
Sec. 3.10 Perimeter Streets	47	Sec. 8.3 Transit and Bicycle Network Connections	88		
Sec. 3.11 Public Right of Way Materials	51	Sec. 8.4 Pittsburgh 2030 District Initiative	89		
Sec. 3.12 Alleys	53	Sec. 8.5 Transportation Demand Management	90		



# Section 1. Introduction

- Sec. 1.1 Purpose 2
- Sec. 1.2 Organization of the Document 3
- Sec. 1.3 Overview and Planning History 4
- Sec. 1.4 A Sustainable Community 5
- Sec. 1.5 Legacy and Placemaking 6





## Sec. 1.1 Purpose

### 1.1.1 Goals and Objectives

The redevelopment of the Lower Hill will be an important part of defining Pittsburgh's future. The goal is to create a new high quality, mixed-use, sustainable development that will establish a renewed connection between Downtown Pittsburgh and the Hill District. Envisioned as a city neighborhood, the Site will have an urban density that responds to its context, be pedestrian oriented, and reflect the strong cultural history of the Site when defining the character of this new neighborhood.

### 1.1.2 The Role of the Lower Hill Redevelopment Site PLDP

Lower Hill Preliminary Land Development Plan (PLDP) is the technical designation of this document. The PLDP accompanies the SP-11 zoning text described below for this district that defines the specific zoning requirements for the site. This document contains both mandatory development requirements and design guidance for the new district.

The PLDP establishes a set of requirements for accomplishing the vision described in the Planning and Design Goals (Section 1.3.1), which reflects the vision of stakeholders that participated in the design process. Sections 2 through 5 present development requirements. Suggested strategies are sometimes provided in Sections 2-4 in order to assist the reader in understanding strategies for implementing the mandatory requirements. Such strategies are not requirements and an effort has been made to appropriately distinguish such strategies from mandatory requirements. Signage regulations are set forth in Section 5. The remaining sections contain non-mandatory recommended guidelines for development. This PLDP is



FIGURE 1.1 Green spaces within the site will be vibrant green spaces serving as a community gathering and events spaces, and important functions such as rainwater collection and retention.

a departure from conventional zoning. While conventional zoning relies upon use designations as the primary determinant of site development and building envelope standards, this PLDP emphasizes the form of buildings and their location on a development site. Most importantly, this document is intended to encourage those sparks of creativity and inspiration from developers that will help create a remarkable rebirth of the Lower Hill and expansion of Downtown.

Upon the City's adoption of the SP-11 Zoning Text, the SP-11 Lower Hill Planned Development (SP District) will be created. The area of the SP District to be redeveloped is sometimes referred to in this PLDP as "The Lower Hill Redevelopment Site" or the "Site". As the project proceeds into implementation and private developers are brought on board, individual blocks or specific areas may be named and branded as may be required, such as for anchor tenants or for marketing purposes. Efforts to rebrand or rename specific portions should be done in consultation with the community.

### 1.1.3 The Illustrative Master Plan

The Illustrative Master Plan of the Lower Hill Redevelopment Site was prepared over many years of planning as a way to build consensus around a shared vision. Stakeholders include the Pittsburgh Penguins, Sports and Exhibition Authority (SEA), Urban Redevelopment Authority (URA), City of Pittsburgh, the Hill District Community, the Uptown Community, the Downtown Business Community, as well as other regional stakeholders. The plan represents a collective opinion about the form, density, and character of development desired for this part of the city. The Illustrative Master Plan was used as the basis for traffic and parking management and design, public amenities, and infrastructure planning, but is not intended to be the actual development plan. Actual development will be approved by the Planning Commission pursuant to final land development plans (each an FLDP) submitted by future developers and applicants.



FIGURE 1.2 The PLDP envisions a walkable, vibrant neighborhood with a mix of uses typical of a traditional Pittsburgh neighborhood.



## Sec. 1.2 Organization of the Document

This page explains the organization of this document for use in planning and designing new development in the Site. The Lower Hill Redevelopment Site is bounded by Crawford Street, Bedford Avenue, Chatham Square, and Centre Avenue. This Section 1 provides an overview. It includes a statement of goals and in particular the goal of sustainable communities. Sections 2 through 4 prescribe mandatory regulations, Section 5 restates language pertaining to signage from the SP-11 Zoning Text, and the remaining sections contain recommendations and guidelines. A note regarding language: Occasionally this PLDP uses the words “public” and “private”. In the context of this PLDP, these terms are not used to ascribe responsibility for development to a public or private entity. “Public” means that development is intended to be accessible to the general public regardless of ownership. “Private” means there is intent to keep the development in the private sector. The term “Penguins” is used in this PLDP to mean Pittsburgh Arena Real Estate Redevelopment, LP.

Sections 2 to 5 contain regulatory provisions applicable to all FLDPs submitted for development in the SP District.



FIGURE 1.3 Section 2.3 – Urban Open Space

### SECTION 2: REGULATING PLANS

The regulating plans establish the framework and specific criteria for streets, blocks, open space, and buildings.

Section 2.2 The Specially Planned District  
Identifies the boundary and sub-districts 1, 2, and 3.

### Section 2.3 Sustainability Requirements and Strategies

Describes sustainability requirements (including stormwater requirements) and strategies to achieve the requirements.

### Section 2.4 Blocks

This plan establishes the intended block structure, block sizes and areas, and Urban Open Spaces.

### Section 2.5 Streets and Pedestrian Connections

This plan depicts the street grid (and street types) that are intended to be established on the Site and discusses essential pedestrian connections.

### Section 2.6 Open Space and Courtyards

This plan describes the locations and areas of required Urban Open Space and recommends additional locations for other green space such as courtyards within development blocks.

### Section 2.7 Street Frontages

The frontages prescribe the relationship between the building and the street. This section determines the amount of block frontage to be occupied by buildings, and the elements that comprise a setback and frontage for buildings.

### Section 2.8 Building Height & View Corridor

A permitted range (maximum and minimum) of building heights is indicated on this plan with the intent of preserving a view corridor through the site.

### Section 2.9 Parking and Service

This section establishes where the Permitted Parking Types and access points (curb cuts) can be located in each block and how to regulate them. On-street parking locations are also indicated.

### Section 2.10 Sub District 3

This section discusses the existing conditions of the CONSOL Energy Center and provides requirements for any future development of Sub District 3.

### SECTION 3: STREET TYPES

This section provides detailed information on the intended design of public rights-of-way, including streets, sidewalks and utility systems that make up the streets types in the Lower Hill Redevelopment Site. The street sizes and designs were prepared with the assistance of traffic planners and landscape architects and respond to the anticipated access needs of development and ground floor uses.

### SECTION 4: BUILDING TYPES

Every building in the Lower Hill Redevelopment Site will correspond to one of the three building types identified in this section. The building types are based on size and height, and are not specific to use. This section provides mandatory standards and guidance for building massing, articulation, and materials.

### SECTION 5: SIGNAGE REGULATIONS

Regulations for building signage, are provided in this section. These regulations are the same regulations set forth in the zoning text governing the SP District.

Sections 6–9 contain guidelines that, while not regulatory, should be reviewed and considered when preparing and reviewing a Final Land Development Plan.

### SECTION 6: SUPPLEMENTAL GUIDELINES

Design guidelines and recommendations for sidewalk cafes, lighting, materials, and furnishings are provided in this section.

### SECTION 7: OPEN SPACE, ART, AND LANDSCAPE GUIDELINES

Design guidelines for Urban Open Space and the use of art and plant pallet recommendations for implementation of landscape requirements and Urban Open Space development are contained in this action.

### SECTION 8: SYSTEMS AND NETWORKS INTEGRATION

The Lower Hill Redevelopment Site must integrate and be integrated into many systems and networks. This section provides recommendations for integration of stormwater, utilities, parking and transit systems and bicycle networks.

### SECTION 9: TRANSIT AND PEDESTRIAN IMPROVEMENTS

Recommendations for improvements to areas within and outside of the site are provided in this section as they have an important impact on the successful development of the Lower Hill Redevelopment Site. For reference, a complete transportation and parking study was conducted by Trans Associates and exists under separate cover.

### SECTION 10: ILLUSTRATIVE MASTER PLAN

The Illustrative Master Plan depicts one example of the development possibilities of this PLDP. It is developed as a way to test capacity, build consensus among the stakeholders, and as a basis for traffic, parking, and engineering analysis. An illustrative design for each block is described in this section. The block studies illustrate a potential program, and the desired relationship between buildings and the public realm.

### SECTION 11: IMPLEMENTATION PROGRAM

Outline of the implementation strategy for the major components of redeveloping the Site: site preparation, infrastructure, open space, and private development.

### SECTION 12: DEFINITIONS

Definitions of terms and words used in this PLDP are provided to aid in the understanding and implementation of the regulations and recommendations presented.



FIGURE 1.4 Goals for the Lower Hill site include sustainable development and LEED-ND certification. The above figure is a sample sustainability notes box that is used throughout the document to highlight goals. These boxes include LEED-ND prerequisites, and other specifications

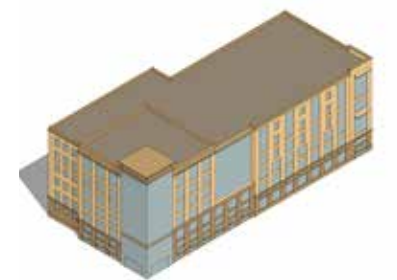

FIGURE 1.5 Section 4 – Sample Building Type



FIGURE 1.6 Section 6 – Sample Drawing illustrating sidewalk condition



## Sec. 1.3 Overview and Planning History

Urban Design Associates (UDA) was first commissioned by the Pittsburgh Penguins in 1999 to explore urban design alternatives for the redevelopment of the 28-acre Civic Arena site and to test alternative locations within the City of Pittsburgh for a new multi-purpose arena. The process involved stakeholders from the Hill District, Uptown, City of Pittsburgh, and Pittsburgh Penguins. These meetings produced urban design principles for the development of the 28-acre site. A primary goal was to reconnect the Hill District to Downtown Pittsburgh.

The process of planning, designing, and constructing a new arena took many years. In March of 2009, with the new CONSOL Energy Center under construction, UDA was asked to again revisit the plan for the 28-acre Civic Arena site. Working with an updated market study and development program prepared by Economics Division of AECOM (completed February 2010), UDA prepared an Illustrative Master Plan. The plan follows the urban design principles established ten years earlier, by replacing the Civic Arena and surrounding parking lots with an urban street grid and the development of housing, offices, and retail consistent with the Greater Hill District Master Plan published by Sasaki in June 2011. The plan is also consistent with the open space recommendations made in the Greenprint document prepared in 2009. The Illustrative Master Plan has the potential to add 1,200 residents and thousands of permanent jobs to the Lower Hill Site Redevelopment, not only increasing the real estate and wage tax base of the City, but also replacing the obsolete arena and surface parking lots with a vibrant neighborhood.

In 2011, the Penguins engaged the Department of City Planning (DCP) to begin the process for establishing a Specially Planned District (SP District) that incorporates the 28 acre site and the CONSOL Energy Center site, and the Crosstown Boulevard I-579 cap. This process was an interactive discussion including the Penguins, SEA, URA, DCP, LaQuatra Bonci Associates (LBA), UDA, Oxford Development, and community representatives. At the outset, seven Planning and Design Goals were established to guide the process (see list below). These goals closely aligned with the original urban design principles that were identified in 1999. The Planning and Design Goals and collaborative evolution of the Illustrative Master Plan during the SP District process culminated in this PLDP document, which is a regulatory document for redeveloping the Lower Hill Redevelopment Site.

### 1.3.1 Specially Planned District Planning and Design Goals

#### A. Sustainability

The project seeks to establish a new standard for large-scale sustainable development in Pittsburgh. Sustainability will be a central tenet in design, construction, and operations; including a broad and dynamic use of landscaping to address heat island, light pollution, and stormwater concerns.

#### B. Urban Design

Regulating plans present development standards and goals that ensure the vision of the Illustrative Master Plan is brought to fruition. The standards are: set strong urban design principles, establish density thresholds, propose streetscape designs, and depict building placement and form standards. The goal is to establish predictability in the quality of human spaces while allowing for creativity in design and flexibility within the development.

#### C. Universal Design & Accessibility

The topography of the site changes significantly, and that condition combined with the goal of providing equal opportunities to all users makes the integration of “universal design” parameters an important component of the design. Special attention was given to the alignment and grades of streets and the location of public spaces to allow for an accessible public realm.

#### D. Transportation & Infrastructure

The design proposes to reestablish an urban street grid on the site in order to reconnect the Hill District to Downtown through better vehicular, transit, bicycle, and pedestrian connections. Site-wide innovative stormwater techniques reduce, reuse, and recapture stormwater. Alternate energy sources such as co-generation and geo-thermal technologies were investigated and are encouraged practices.

#### E. Open Community Process

The project will continue to engage the public in the design and implementation process. Involvement is and has been channeled through focus groups, stakeholder gatherings, and open public meetings, which have brought meaningful improvements to the design along the way.

#### F. Balance of Uses

The Illustrative Master Plan represents a targeted mix of uses as supported by the 2010 market study. The regulating plans, however, allow for flexibility in development patterns to account for varying market demands while maintaining the necessary balance of density and uses to ensure success in every phase of development.

#### G. Implementation Program

The Implementation Program as required by Section 909.01.B.9 of the Zoning Ordinance is set forth in Section 11 of this PLDP.



FIGURE 1.7 Site Locator Map: The site lies east of Downtown Pittsburgh and is surrounded by the Hill District and Uptown.



## Sec. 1.4 A Sustainable Community



The Lower Hill Redevelopment Site intends to establish a new standard for sustainable development. New development should therefore model the three tenets of sustainability; social, environment and economic, in an urban context. Sustainability as a key principle takes the form of a multifaceted approach to protection of the environment, consideration of the use

of materials, addressing social progress, and attention to economic growth and employment. The vital components of a sustainable community should not be limited to green solutions for buildings and site work. Strategies for achieving a sustainable community are described in greater detail in Section 2.3 of this PLDP, while the social and economic initiatives are described in greater detail in the Implementation Section of this document.

The goal of sustainability in a physical sense is threefold — to reduce pollution, conserve energy and resources, and to enhance natural systems. The planning team has studied the research on environmental sustainability practices, and has sought local and national experts to provide direction towards achieving sustainability and setting a new standard for Pittsburgh. The approach to achieving an environmentally sustainable community in the Lower Hill Redevelopment Site is two-part and is discussed further in Section 2.3:

1. Develop the Site in accordance with LEED for Neighborhood Development (LEED-ND); and
2. Establish a sustainable stormwater management strategy throughout the Site.

Sustainability also encompasses socio-economic issues seeking to restore and enhance a balanced community. The Lower Hill Redevelopment site offers a number of opportunities to positively impact the social and economic conditions in the Greater Hill District. Over the past several years the Penguins, public leaders and community representatives have been meeting to discuss ways in which the Lower Hill Redevelopment can be leveraged to this end. The outcome of these discussions is a Community Collaboration and Implementation Plan (CCIP) that provides a framework for positive impacts through the collaborative participation of the project sponsors, developers, service providers, local corporations, foundations and the immediate community. The CCIP identifies focus areas of Minority and Women Business Enterprise inclusion, homeownership and affordability, wealth building initiatives, workforce development and jobs as well as a process for celebrating the legacy and history of the site and coordinating community development. The CCIP is intended to work in parallel with the Preliminary Land Development Plan and to be implemented over the course of the redevelopment.

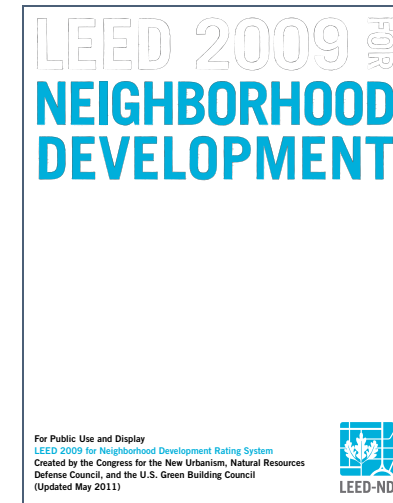

FIGURE 1.8 Example of a sustainable street design that contributes to reducing off-site runoff.



## Sec. 1.5 Legacy and Placemaking

Placemaking is an important aspect of planning the future of the Lower Hill site. Attention to this aspect of planning ensures that redevelopment will reflect the unique characteristics and context of the Lower Hill and preserve the Lower Hill and the site’s legacy and unique history.

The Lower Hill neighborhood has a unique history that should be recognized in the redevelopment of the site. Historical neighborhoods in the Hill District included those that were once known as “Minersville,” “Lacyville” and “Little Hayti.” The upper and middle portions of the Hill District were originally settled predominately by Germans and Scotch-Irish until the 1880s when central and eastern Europeans began to settle in the same area.

The most eastern area of the Lower Hill was called “Arthursville” and was home to a growing black population. Prior to the Civil War, this neighborhood was the home of freedmen, a center of abolitionism, and a stop on the Underground Railroad. During the years leading to World War I, the community grew when African-Americans left the South at the urging of industrial recruiters who promised good wages and the community continued to grow throughout the years of the “Great Migration” of blacks to the North.

Immigrants from outside the United States further swelled the population of the Hill District, and it became a melting pot of Russians, Slovaks, Irish, Armenian, Syrian, Lebanese, Italians, Greeks, Poles, Chinese and Jews. These immigrant communities together with the established groups of African-Americans, Germans and Scotch-Irish, wove a rich and vibrant ethnic tapestry that contributed to a bustling community.



FIGURE 1.9 Crawford Recreation Center Baseball Club, 1926. Source: Dorsey-Turfley Family Photographs, 1880–1987 (Bulk 1900–1950, MSP455, Library & Archives, Senator John Heinz History Center)

The 1930s–1950s defined a vibrant era for the Hill District. The Negro Baseball League flourished with the Hill District-based “Pittsburgh Crawfords” owned by prominent Hill District business owner, Gus Greenlee, commerce thrived along Wylie and Logan Streets and a remarkable Jazz scene emerged. It was during this time that the area became known as “The Crossroads of the World” and “Little Harlem”. During a time of racial tensions, this was one of the few places with integrated bars and clubs — a place where color did not seem to undermine the desire to celebrate music. The Hill District became an important stopping point for many Jazz greats, black and white alike.

While certain aspects of the Hill District were thriving, the physical structures were decaying. Although there was debate about the quality of housing, proponents of urban renewal deemed parts of the Hill District as “substandard” and in 1955 slated 95 acres for demolition. This clearing of land displaced many Hill District residents and businesses, and fractured the neighborhood fabric. The building of new highways compounded negative community impacts by separating the Lower Hill from Downtown.

The Urban Renewal plan for the Lower Hill focused around a Center for the Arts intended as a home for the Civic Light Opera, along with the creation of luxury apartments, hotels and offices. Little of this plan was fulfilled, but construction of the Civic Arena began in 1958, and the arena opened in 1961. The arena was celebrated as a major feat of engineering with its stainless steel dome and the first retractable roof for a major cultural venue. It served as a venue for historic performances, political rallies, and a variety of sporting events. The Civic Arena, also referred to as “The Igloo,” was the home to the Pittsburgh Penguins from 1967–2010 and was demolished in 2012 after its functions were relocated across Centre Avenue to the new CONSOL Energy Center. The diverse history of the site calls for recognition of this legacy in its future redevelopment. This legacy may be expressed through, among other things, the design of public spaces, streetscaping, signage and public art. Further, the proximity of the new CONSOL Energy Center and the interface with the ongoing Hill District initiatives present a unique opportunity to take cues from the old and the new to define the character of the Lower Hill moving forward.

### 1.5.1 Implementing Placemaking Principles

Placemaking will be achieved by working with the community to preserve and incorporate the history of the Lower Hill in the design of the public areas within the Lower Hill site. The following are a selection of the key action items identified by the community that will be pursued during the course of development.

- » Engage in community discussions regarding naming of streets within the Site to reflect historic street names or well-known greater Hill District residents.
- » Engage in community discussions regarding naming of structures, and open space within the Site. Include the history of the site (such as Arthursville, Minersville, Civic Arena) and references to Freedom Corner in addition to other key assets within the neighborhood.
- » Provide historic context of the Site in relation to the greater Hill District and in doing so encourage residents and visitors to explore the greater Hill District above Crawford Street.
- » Engage in community discussions regarding fundraising for the Curtain Call Project
- » Collaborate and create programmatic component to be held in open spaces for live cultural and artistic performances.
- » Promote cultural and artistic events and key information about the neighborhood to visitors of the SP-11 Lower Hill Planned Development District subject to signage regulations



FIGURE 1.11 The Civic Arena pre-demolition

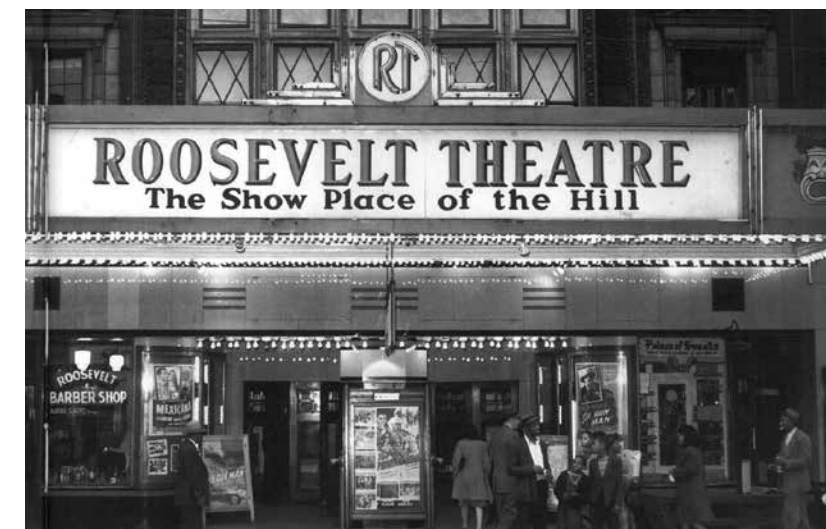

FIGURE 1.10 Source: Once Shot Harris- The Photographs of Charles “Teenie” Harris by Stanley Crouch, Carnegie Museum of Art, 2002



# Regulatory Standards: Section 2–5

## Section 2. Regulating Plans

Sec. 2.1 Introduction	8
Sec. 2.2 The Specially Planned District	9
Sec. 2.3 Sustainability Requirements and Strategies	10
Sec. 2.4 Blocks	15
Sec. 2.5 Streets and Pedestrian Connections	16
Sec. 2.6 Open Space and Courtyards	17
Sec. 2.7 Street Frontages	19
Sec. 2.8 Building Height and View Corridor	28
Sec. 2.9 Parking and Service	31
Sec. 2.10 Sub District 3	35

### SUSTAINABILITY GOALS



- » Specify materials with recycled or reclaimed content, locally manufactured materials, and high performance materials
- » Design a neighborhood that has a mix of uses to reduce vehicle trips and provides an interconnected pedestrian network for ease of walkability
- » Design a neighborhood that provides multi-modal transportation options and encourages alternative modes (ie: frequent bicycle racks and bus shelters)
- » Implement a sustainable stormwater approach that reduces rainwater runoff while accumulating non-potable water for reuse in landscape and in servicing buildings

### APPLICABLE LEED-ND POINTS (2009 Standards)

- NPD Pre 1 — Walkable Streets
- NPD Pre 3 — Connected and Open Community
- NPD Credit 1 — Walkable Streets, Facades and Entries, Ground Level Use, Parking, and Sidewalk Intrusion
- NPD Credit 5 — Reduced Parking Footprint
- NPD Credit 6 — Street Network
- NPD Credit 7 — Transit Facilities
- NPD Credit 8 — Transportation Demand Management
- NPD Credit 9 — Access to Civic and Public Space
- NPD Credit 10 — Access to Recreation Facilities
- NPD Credit 11 — Visitability and Universal Design



## Sec. 2.1 Introduction

The Regulating Plans are created as the primary frameworks to the development of the Site. This chapter contains regulations related to the location of key elements and relationships, while flexibility is maintained with regard to the form and location of buildings, the mix of uses, architectural character, open space design, and amenities. Therefore, this section prescribes the location of public rights-of-way, Urban Open Space (as required by the City of Pittsburgh Zoning Ordinance), building frontages along streets, building heights, access to parking, and the desired treatment of transit and parking facilities. Given the importance of sustainability in this redevelopment, Sustainability Requirements are also described in this chapter.



© 2014 URBAN DESIGN ASSOCIATES

FIGURE 2.1 This illustration indicates the scale and density that can be achieved by following the regulating plans described on subsequent pages.



## Sec. 2.2 The Specially Planned District

In connection with this PLDP, the City will establish the SP-11 Lower Hill Planned Development District pursuant to Section 909.01 of the City of Pittsburgh Zoning Ordinance. The SP District will be bounded as outlined in the plans to the right and will contain three Sub Districts. In addition to the Regulating Plans set forth in the PLDP, each Sub District will be subject to the SP-11 Zoning Text adopted for that Sub District. The Regulating Plans and the SP-11 Zoning Text are intended to enable redevelopment of the Lower Hill.

The uses permitted in each Sub District will be governed by the SP-11 Zoning Text. Sub District 1 is suited for residential uses, due to its proximity to existing residential use in the Hill District. Sub District 2 is suited for a mix of uses such as residential, office, retail, hotel, entertainment, and food and beverage. Sub District 3 includes the existing CONSOL Energy Center site and adjoining parking garage. Because existing structures within Subdistrict 3 were approved pursuant to a Project Development Plan, the following pages give preference to Sub Districts 1 and 2. Regulating Plans for any changes to the future use of Sub District 3 are included in Section 2.10.

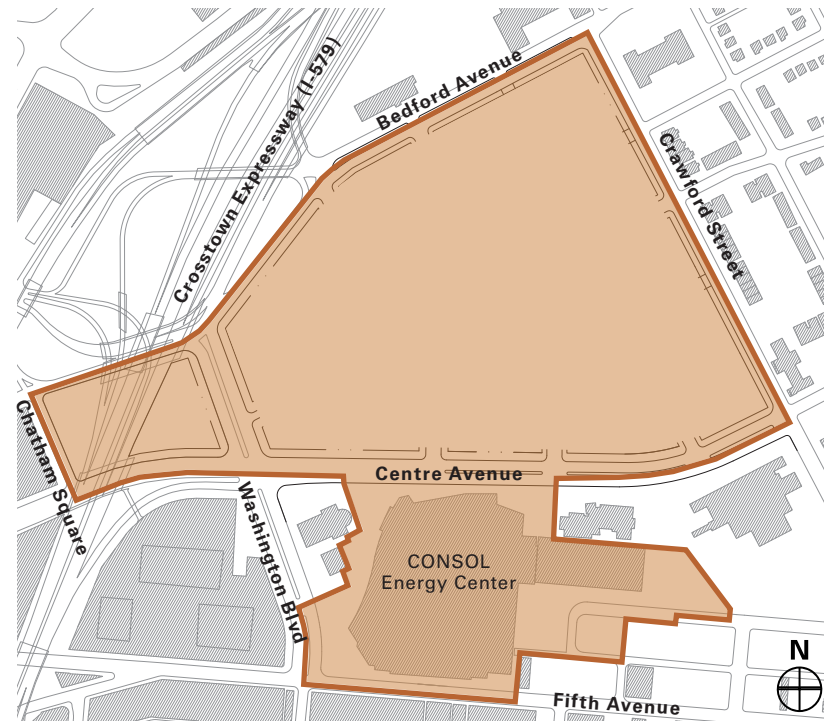

FIGURE 2.2 SP District Boundary Diagram

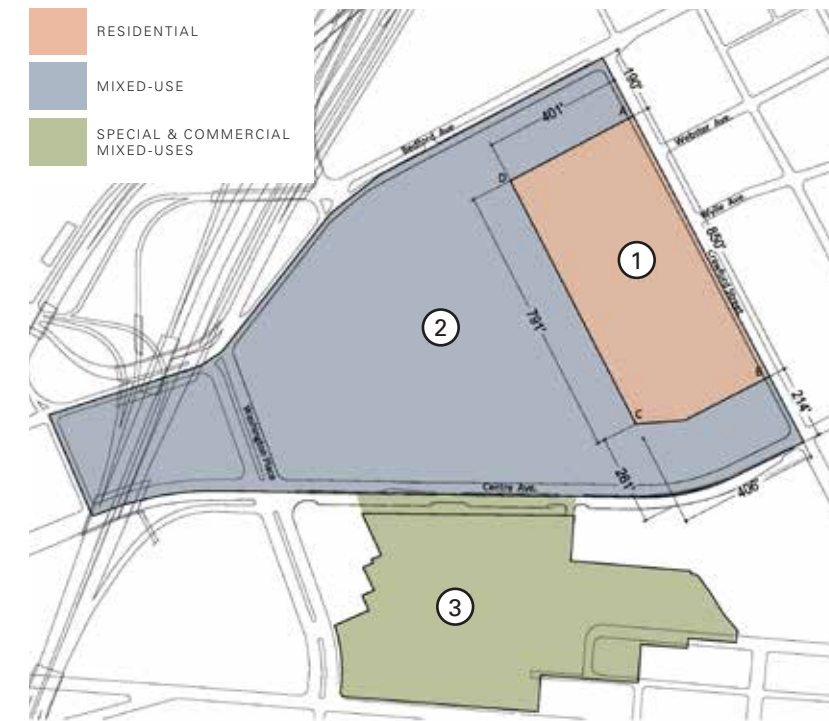

FIGURE 2.3 Sub Districts Diagram



FIGURE 2.4 Context for Sub District 1



FIGURE 2.5 Context for Sub District 2



FIGURE 2.6 Context for Sub District 3



## Sec. 2.3 Sustainability Requirements and Strategies

Section 2.3.1 sets forth the two sustainability requirements applicable to all development within the Lower Hill Redevelopment Site. Sections 2.3.2 and 2.3.3 discuss background related to the sustainability requirements. Section 2.3.4 is provided for the convenience of the reader and includes strategies available to developers for implementation of the requirements set forth in 2.3.1.

### 2.3.1 Sustainability Requirements

The following are requirements governing development:

#### 1. Develop all portions of the site in accordance with LEED for Neighborhood Development

» (LEED-ND). Each submission of a Final Land Development Plan for review and approval by the Planning Commission shall include a "LEED ND Planning Submission". The LEED ND Planning Submission means a report that includes (i) a LEED ND scorecard based on an approved LEED ND plan as determined by the U.S. Green Building Council, (ii) a LEED for Neighborhood Development Project Checklist identifying all potential LEED ND points, and (iii) a narrative explanation identifying which checklist points will be achieved and which checklist points will not be achieved in connection with the proposed development. Each LEED ND Planning Submission may acknowledge and/or account for work performed in connection with other aspects of the Lower Hill Redevelopment Site, such as public infrastructure. For clarification, an applicant will be in compliance with this section by submitting a LEED ND Planning Submission together with a representation to Planning Commission that it will submit (or has submitted) a LEED ND certification application to the U.S. Green Building Council for consideration.

#### 2. All improvements shall achieve retention of 1.2 inches of rainfall depth.

» Each submission of a Final Land Development Plan for review and approval by the Planning Commission shall demonstrate how the rainfall retention requirement will be met.

The following subsections are provided for the convenience of the reader and include strategies available to developers for the implementation of the above listed requirements.

### 2.3.2 Discussion of LEED-ND Requirements

LEED has long been the standard for sustainable buildings and development. LEED-ND is a rating system that combines the principles of smart growth, New Urbanism, green infrastructure, and green building. This PLDP aims to achieve LEED ND certification for the entire Lower Hill Redevelopment Site. By following LEED-ND standards, the Lower Hill Redevelopment Site will successfully bring together development form, transportation systems, open space network, and green infrastructure. The Lower Hill Redevelopment Site is well positioned to become LEED-ND certified or higher. Its urban location, proximity to transit and Downtown businesses, opportunity to build a new infrastructure system, and the potential for many high performing buildings, all help fulfill the standards of the scoring system.

In an effort to establish a benchmark, the design team (in July 2012) scored the project based on LEED-ND 2009 requirements, using the Illustrative Master Plan and program, current statistics of the immediate surroundings and the collective desires of all stakeholders. Scoring justified the pursuit of certification as a basic goal with a higher level achievable. Therefore, LEED-ND prerequisites have been embedded in this PLDP document to establish minimum requirements for the Site. Failing to comply with the prerequisites will preclude certification. Developers and designers are responsible for complying with the latest version of LEED-ND to score the performance of their desired development, and individual developers should use reasonable efforts to coordinate with other developers within the Lower Hill Redevelopment Site to achieve LEED-ND certification for the entire site.



FIGURE 2.7 Creative use of outdoor space which incorporates above-ground retention (High Line Park, NY)



FIGURE 2.8 Stormwater retention area with native plantings and gabion walls

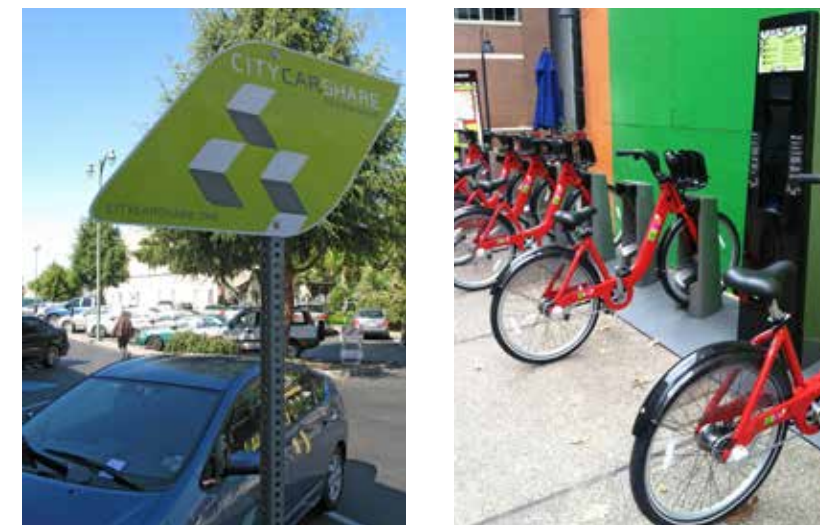

FIGURE 2.9 LEED-ND encourages the use of alternate modes of transit to reduce vehicle trips and encourage walkability



**2.3.3 Discussion of Stormwater Management Requirements and Techniques**

The USGBC’s LEED ND System recommends an aggressive approach to managing stormwater runoff. The stormwater management credit requires implementing a stormwater management plan for the entire development footprint that “retains on-site, through infiltration, evapotranspiration, and /or reuse the rainfall volumes generated from the 80th, 85th, 90th, 95th percentile rainfall depths (1–4 points).” Based on the historic rainfall data (published by NOAA for Pittsburgh, PA between 1980 and 2010), the 80th, 85th, 90th, and 95th percentile storm depths are 0.6-inches, 0.75-inches, 0.9 inches, and 1.2-inches, respectively.

The City of Pittsburgh Stormwater Ordinance similarly requires publicly-funded development /re-development projects to have on-site management systems for rainfall events less than or equal to the 95th percentile. The stated 95th percentile rainfall depth in the ordinance (through the year 2015) is 1.2-inches. The average annual rainfall depth in Pittsburgh is approximately 38-inches (for the period of record 1980–2010) per year. This equates to an average annual volume of rainfall equal to 31.3 million gallons over the development footprint (approximately 30-acres). The existing condition is highly impervious (approximately 83 percent impervious), thus generating approximately 26 million gallons of stormwater runoff annually.

In order to align with the stormwater management recommendations of the LEED-ND Rating System and the City’s Stormwater Ordinance, low impact development and green infrastructure techniques may be implemented to retain and infiltrate, evapo-transpire, and reuse rainwater — in lieu of allowing it to run off. Retaining up to the 1.2-inch rainfall depth on site would reduce the annual stormwater runoff volume to approximately 5.3 million gallons (a reduction of approximately 20.7 million gallons, or 80%, from the current 26 million).



FIGURE 2.10 Above-ground retention



FIGURE 2.11 Below-ground retention



FIGURE 2.12 Stormwater wetlands in bloom. Variety of textures and colors provide visual interest for the pedestrian realm.



FIGURE 2.13 Passive stormwater retention occurs at this recessed lawn where rain can gradually infiltrate



### 2.3.4 Sustainable Strategies

The current urban landscape of the Lower Hill Redevelopment Site is unique in that it offers enormous possibilities for revitalization. A new landscape — green, productive, and welcoming — can be achieved by applying innovative sustainable solutions to transform various aspects of the site. The following strategies are available for meeting the requirements set forth above. These strategies focus on capturing and treating stormwater, providing for green infrastructure and buildings, as well as habitat restoration and urban planting strategies. The Urban Forest Master Plan, as prepared by Tree Pittsburgh, also provides some best practices that could be used to achieve sustainability requirements. The collective goal of all of these strategies is to better manage stormwater on the site. Other strategies should also be considered as technologies rapidly change during the implementation of this PLDP.

The sustainable strategies available to all parties are divided into three categories that are derived from the application of new design standards that seek to integrate the above sustainable requirements. The sustainable strategies applied to this site are divided into three initiatives:

- » Development Blocks
- » Urban Open Spaces
- » Rights-of-Way

In each of these categories, options suggested pertain both to management of stormwater generated within such area, and the use of such area to support management of stormwater generated from other areas. Any sustainable street strategies implemented within the public right of way must be reviewed and approved by the Pittsburgh Department of Public Works.

#### A. Development Blocks Sustainable Strategies

- » **Generally:** within each block, developers should consider an array of localized or centralized techniques, including green roofs, blue roofs, porous pavement, amended soils, infiltration practices, and rainwater harvesting, to retain on-site and infiltrate, evapotranspire, and reuse all rainfall depths up to the 1.2-inch depth. To the extent that on-site retention is not sufficient to meet stormwater retention requirements, shared facilities for holding stormwater should be considered.
- » **Green Roofs:** within each parcel, developers should consider incorporating green roofs into their roof plan design. Numerous benefits can result from the adoption of green roof technologies including the recovery of green space, moderation of the urban heat island effect, improved stormwater management, water and air purification, and a reduction in energy consumption. A major benefit of green roofs is their ability to

absorb stormwater and release it slowly over a period of several hours. Green roof systems have been shown to retain 60–100% of the stormwater they receive. In addition, green roofs have a longer life-span than standard roofs because they are protected from ultraviolet radiation and the extreme fluctuations in temperature that cause roof membranes to deteriorate.

- » **Blue Roofs:** within each parcel, developers should consider incorporating blue roofs into their roof plan designs when not using green roofs (discussed above). Blue roofs are a type of green infrastructure that function similar to green roofs, but without vegetation. Blue roofs temporarily store water to help mitigate the “first flush” of rainfall and then release the captured storm water incrementally. These systems typically cost less than green roofs and produce desired stormwater management results.
- » **Permeable Paving:** In addition to using green roofs to capture run-off, permeable paving may be used in private alleys, courtyards, and pedestrian ways in order to help control stormwater.
- » **Shared or Regional Stormwater Facilities:** Shared stormwater retention systems may be implemented at development parcels or at Urban Open Spaces. See strategies for stormwater detention systems described in Section B on the page that follows.
- » **Additional methods addressing sustainability:** In the book *Ten Shades of Green — Architecture and the Natural World* (Peter Buchanan and Kenneth Frampton, 2005) ten strategies are laid out:
  - » Low Energy Performance – Achieved by making maximum use of natural light and ventilation
  - » Replenishable Sources – Harvest non-depletable ambient energies of the sun, wind, waves, gravity, and geo-thermal power
  - » Recycling: Eliminating Waste and Pollution – Re-use building materials, design buildings that are flexible and easily reused, recycle water and heat
  - » Embodied Energy – Look at energy efficiency in material selection in terms of life-time energy use
  - » Long Life, Loose Fit – Build with materials that endure and improve with age; green buildings not only accommodate change easily but are timeless and pleasant in character so that people prefer to conserve them
  - » Total Life Cycle Costing – Balance capital cost with long term maintenance costs

- » **Embedded in Place** – Green buildings fit seamlessly into, help reintegrate and minimize negative impacts on their surroundings
- » **Access and Urban Context** – to be green, integrate multimodal transportation alternatives
- » **Health and Happiness** – Natural light, fresh air, and contact with nature and community provide a healthy lifestyle
- » **Community and Connection** – Achieve a sustainable culture by regenerating a sense of community and connections with the natural world



FIGURE 2.14 A Green Roof open space with a promenade, native plantings, and seating.



FIGURE 2.15 Native perennial planting on the Allegheny County Office building’s Green Roof provide visitors with an unexpected garden.



FIGURE 2.17 A class meeting on a Green Roof. Green Roofs provide additional usable outdoor space within the urban fabric.



FIGURE 2.16 Detail photos showing extensive plantings on the left versus intensive plantings requiring more soil depth on the right.



## B. Urban Open Space

Urban Open Space is a critical element of the design plan. Requirements related to Urban Open Space are set forth in Section 2.6 of this PLDP. The development of Urban Open Space should create distinct civic places, provide passive recreation opportunities for residents, and provide opportunities for establishing ecosystems, habitats, and landscapes. Urban Open Space may be appropriate for recreating large expanses of habitat and handling small or large volumes of stormwater. During storm events, run-off may be directed from adjacent streets and development parcels towards rain gardens and open space. Usable green space at the Urban Open Space may also function as temporary stormwater detention areas during storms. Urban Open Space may be designed to supplement the capture of stormwater if necessary to support requirements on private development sites or to capture excess rainwater from the streets with a retention system sized and designed to handle storm events. Stormwater management techniques may include sub-surface infiltration and/or rainwater harvesting. A retention facility could be designed so that harvested rainwater is reused for irrigation or ornamental water features or other non-potable water uses, such as toilet flushing or use in a cooling tower.

Strategies suggested for all open spaces can be naturalistic as well as urban in form and character. Inspiration for the design of these features should be drawn from Pittsburgh's landscape. Walkways and paths should wind seamlessly through the landscape employing subtle control features. Phyto-remediation, reforestation, and slope stabilization can and should occur in Urban Open Spaces.

In addition to landscape treatments within green spaces, alternative paving materials may be used to locally infiltrate rainwater and reduce the runoff leaving a site. This can help to decrease downstream flooding, the frequency of combined sewer overflow events, and the thermal pollution of sensitive waters. Use of these materials can also eliminate problems with standing water, provide for groundwater recharge, control erosion of streambeds and riverbanks, facilitate pollutant removal, and provide for a more aesthetically pleasing site. The drainage of paved areas and traffic surfaces by means of permeable systems is a key component on the Lower Hill Site Redevelopment that seeks to achieve a stormwater management system emulating natural conditions.

When development occurs, the following criteria should be considered when laying out green space.

- » Sun Alignments: Where sun is abundant, shade for comfort and safety in activity areas should be provided through trellises, pavilions, or shade trees.
- » Prevailing Winds: The major advantage of wind in recreational development is its cooling aspect. Orientation of site furniture should account for catching summer breezes while a portion should provide protection from winter winds.
- » Relationship to Downtown: Maximize pedestrian access to the Downtown while restoring or creating natural habitats and ecosystems existing on-site.
- » View Corridors: Views are an asset to the new district and reinforce a visitor's experience. Site location of amenities should maximize views of natural features and minimize views of visitor and support facilities.



FIGURE 2.18 Native planting that increases habitat and is low maintenance



**C. Public Right-Of-Way: Sustainable Streets**

In the reconceived Lower Hill Redevelopment Site, sustainable streets will be employed where appropriate. The design intent of the sustainable street is to capture, control, and treat the ‘first-flush’ of rain fall. During storm events, there will be a tremendous volume of run-off generated from paved, impervious surfaces which will be captured and controlled by structured tree reservoirs.

The strategies suggested for the sustainable street also mimic the natural infiltration process in controlled, limited means. Stormwater should be directed through channels or runnels to pools or collection basins that are not only functional but sculptural. These pools or basins allow the water to soak back into the soil layers, while providing shade and greenery for pedestrians.

There should be a structure and geometry to all the control features, following the geometric patterns of the streets and urban landscape features. Materials also may include broom finish and exposed aggregate concrete with permeable pavers between tree pits and stormwater basins. In addition permeable pavers could be used in the parking lanes or on sidewalks to further reduce stormwater runoff.

The following approaches are recommended:

- » Public streetscapes will implement sustainable street techniques. These sustainable strategies may include stormwater infiltration basins described below to treat and retain the maximum volume of stormwater feasible, porous parking strips, or conveyance to a regional stormwater facility.
- » Regional stormwater facilities may be implemented at the Urban Open Space to manage stormwater runoff from the public streets. The stormwater management techniques may include sub-surface infiltration and / or rainwater harvesting. The regional facility may be sized to retain and infiltrate or reuse the volume of stormwater generated from the streets (including any excess from the sustainable streets) for up to the 1.2-inch rainfall. Harvested rainwater may be reused for irrigation or ornamental water features or other non-potable water uses, such as toilet flushing or cooling tower makeup.
- » Stormwater infiltration basins (tree box filter) described below are designed to specific site conditions when construction begins to the following criteria (which are flexible depending on the steepness and slope of the specific site conditions):
  - › Minimum size of 100 square feet.
  - › Capacity includes 7 inches of depth above topsoil depth to handle storm surges.

- › Soil depth at a minimum of 30 inches and be comprised of a bioretention soil medium to infiltrate water.
- › At least one curb cut with grate covering would be located at the top of each tree box filter.
- › On the sidewalk side, the curb should be broken in at least two locations to allow water to enter the tree box filter.
- › An overflow device would be installed to handle any overflow capacity tied into the stormwater infrastructure.
- › For gradients over 5%, site specific catchment techniques should be

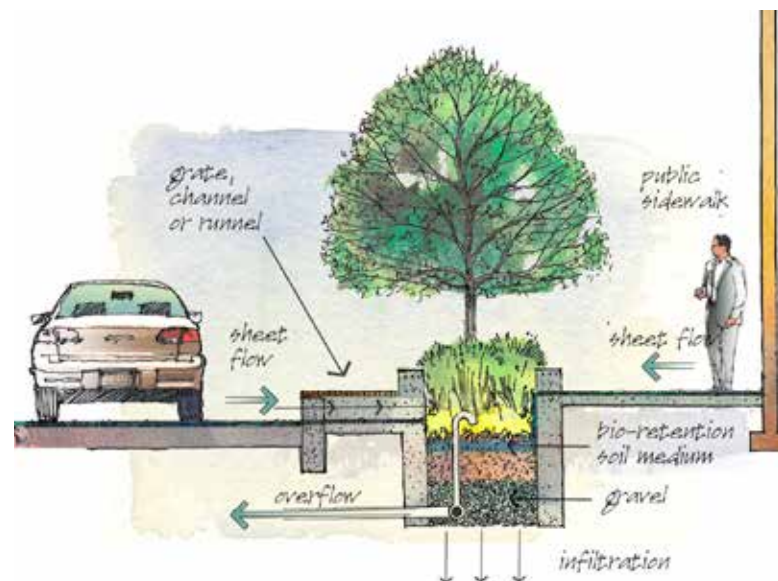

FIGURE 2.19 Prototypical example of stormwater infiltration basin

considered as a recommendation above these criteria.

- › The use of permeable pavers should be used as a secondary source of stormwater control if needed.

Each of the above initiatives provide great potential for a variety of sustainable strategies, and each will have a different visual character. Any development promoted as ‘green’ or ‘sustainable’ should not only seek to restore lost natural processes but should also celebrate natural systems as an integral component of a healthy community.



FIGURE 2.20 Sketch showing roof runoff channeled to bioswales in curb bumpout planters.



FIGURE 2.21 Sketch showing roof runoff channeled to infiltration pits at street.



FIGURE 2.22 Curb cuts in planters allow stormwater runoff to enter infiltration planting pits.



FIGURE 2.23 Decorative grates cover flush curbs allowing street runoff to enter infiltration planting pits.



## Sec. 2.4 Blocks

Development Blocks are established in sizes that allow for flexibility, providing for a wide range of uses to be built within. The dimensions and acreage of each block are provided in the plan to the right. Blocks can be broken down further into development parcels for the purposes of phasing development projects. Each Block is identified by a letter for reference within this document.



FIGURE 2.24 Block Regulating Plan Note: All dimensions and area quantifications are based on available GIS data and are horizontal measurements. Consult final site survey for accurate data.



## Sec. 2.5 Streets and Pedestrian Connections

The streets within the site are laid out to work with the steep topography while providing adequate development blocks. The street types range in width and include various sidewalk and landscape conditions to promote intended street character. All streets will be two-way traffic with on-street parking and street trees. The street types and perimeter sidewalk types are classified in the plan to the right. Further information for each type can be found in Section 3 of this document.

Several streets are designed to be 5% slope or less (see diagram below); therefore, they are identified as key pedestrian streets and shall meet accessibility standards. Streets with 5% slope or less are also ideal candidates for Sustainable Street stormwater management details and technologies. See Section 6 for further information on sustainable streets.

In addition to public streets, it is important to provide cross-block pedestrian connections within the development blocks to enhance mobility. These pedestrian connections can take the form of pedestrian easements, pathways through buildings and courtyards, or private and/or public alleys. Pathways through buildings are discouraged when possible, in favor of more publicly accessible solutions. These connections must be clearly designed for pedestrian use and as such shall be fully visible from the street, signed and lit accordingly, and be designed to ensure a safe and pleasant pedestrian experience. When connections are provided through a building, they must be clearly marked and open at all times.

The plan to the right indicates a zone (shown in green) within which pedestrian connections are required. These zones are intended to indicate desire lines for mid-block connections. The specific locations of these connections are flexible as long as they provide the intended connectivity. Private alleys may be subject to a public easement with specific regulations if intended as a pedestrian connection. The historic alignment of Webster Street in particular is an important link to the neighborhood and will be preserved as a Required Easement in order to ensure connectivity. In addition, private alleys may be required to access parking and service within a block.

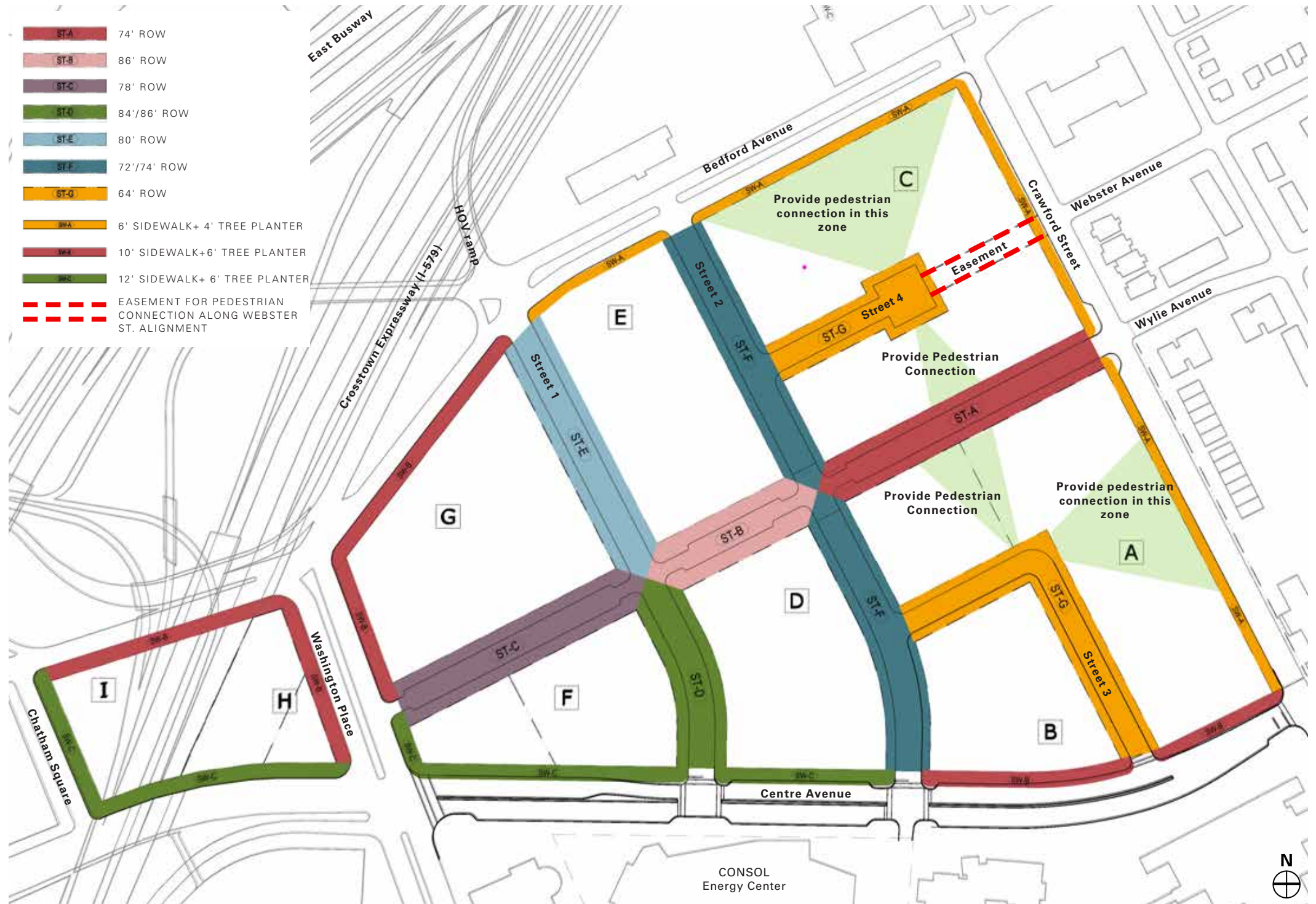

FIGURE 2.26 Street and Connections Regulating Plan



FIGURE 2.25 Accessible Streets Diagram



## Sec. 2.6 Open Space and Courtyards

### A. OPEN SPACE AND COURTYARDS GENERAL

This Lower Hill PLDP is designed to make a meaningful impact on the City's overall open space system. Sec. 909.01.D.3 of the Zoning Code requires that 10% of the gross land area be dedicated Urban Open Space. This 10% Urban Open Space requirement will be aggregated into four new Urban Open Spaces in Sub-Districts 1 and 2, which, when combined with the existing Urban Open Space in Sub-District 3, will meet the 10% Urban Open Space requirements for the SP-11 Lower Hill Planned Development District. The four Urban Open Spaces are located at blocks A, C, F and H as shown on Figure 2.27. These Urban Open Spaces will be publicly accessible and otherwise meet applicable Urban Open Space requirements of the Zoning Code. Except for the Urban Open Space for the CONSOL Energy Center (which already exists), and the Urban Open Space at Block C which provides for a pedestrian easement the individual Urban Open Spaces may be constructed in phases, and in conjunction with the requirements set forth below. Maintenance of Urban Open Space will be provided through the filing of a legally binding agreement as required in section 909.01.D.3.(C)(3) of the Zoning Code. Other open space within development blocks, such as 'courtyards', will not be required to satisfy the zoning requirements.

Urban Open Spaces may contain a mixture of soft landscape and paved areas designed to create a variety of areas with different functions, some of which may handle stormwater. To preserve the integrity of Urban Open Space, surface parking lots and integral parking shall not face onto any Urban Open Space unless adequately screened in a manner compliant with the standards provided in Section 2.9.3 of this PLDP.

To the extent courtyard spaces, other open space and private alleys are provided, they should be designed to be used by residents and visitors to the SP-11 Lower Hill Planned Development District. Courtyards may be at grade or elevated (such as terraced courts or above podium parking). Primary entrances to buildings shall be from the street-facing facades, yet secondary access can and should be provided from courtyards or alleys. Courtyards are also an important component of pedestrian connectivity.

### B. SUB-DISTRICT 3 URBAN OPEN SPACES

Sub-District 3 includes required Urban Open Space as shown on Figure 2.28 as part of the final approved and constructed CONSOL Energy Center. This Urban Open Space is counted towards the overall 10% requirement for the SP-11 Lower Hill Planned Development District.



FIGURE 2.27 Urban Open Space and Courtyards Regulating Plan



**C. URBAN OPEN SPACE PROGRAMMING**

Urban Open Spaces shall be designed, completed and operated in accordance with the following development programs. These programs are conceived in accordance with the placemaking principles of Section 1.5.1 of this PLDP.

**Block A Urban Open Space (Community Open Space).** This space shall be a gathering place open to the public that takes into consideration the residential nature of Sub-district 1. For the convenience of the reader, one strategy for meeting this requirement is to provide a wide range of amenities such as play zones, courts, and community gardens.

**Block F Urban Open Space (Civic Open Space/Major Public Destination Facility Plaza).** This space shall be located at the heart of the SP District and shall provide opportunities for community gatherings and festivals. The space shall complement the adjacent Major Public Destination Facility, CONSOL Arena, across Centre Avenue and shall enhance the retail nature of Wylie Avenue. For the convenience of the reader, strategies for meeting this requirement may include a comprehensive signage plan for the Major Public Destination Facility Plaza, permitting food vendor kiosks and providing access to food trucks within or adjacent to the plaza and providing amenities such as an amphitheater, a gathering lawn and seating areas.

**Block H Urban Open Space (Anticipated Part of CAP Project).** It is intended that Block H Urban Open Space be developed in connection with the CAP project which will bridge the gap from the Lower Hill Redevelopment Site to Downtown Pittsburgh.

**Block C Urban Open Space (Required Easement).** This space shall provide a pedestrian connection between Bedford Avenue and Street 4 aligned with Webster Avenue.

**D. DEVELOPMENT SCHEDULE FOR URBAN OPEN SPACE**

A Final Land Development Plan shall be required for each of the Urban Open Spaces located on Blocks A, C, F and H. These Final Land Development Plans are to be submitted concurrently with Final Land Development Plans for private development blocks as per the schedule set below and must contain a design and a schedule for completion. The design of the Urban Open Space shall consider any stormwater requirement from adjacent blocks or right-of-way as well as specific conditions for the block based on program, access, service and adjacent buildings and uses. Urban Open Space Final Land Development Plans shall also include a signage plan in addition to other elements reasonably required by Planning Commission that facilitate the applicable program components set forth in Section C

above. The Block C Urban Open Space (Pedestrian Easement) will be developed as part of the adjoining Block C property and the FLDP for the adjoining property will include specifics pertaining to the Pedestrian Easement.

Any proposed phasing of Urban Open Spaces must be identified in the Final Land Development Plan for review and approval by the Planning Commission. Any changes to an approved phasing plan, completion schedule or design shall be made in accordance with the provisions of Section 922.11C.4 of the zoning code pertaining to amendments to Final Land Development Plans.

**Block A Urban Open Space (Community Open Space)** shall be commenced upon approval of the first Final Land Development Plan for development on any of Blocks A, B or C and all improvements for such Block A Urban Open Space shall be completed in accordance with a phasing schedule approved by the Planning Commission as part of the FLDP for the Block A Urban Open Space. The Block A Urban Open Space shall be completed no later than the issuance of the final occupancy permit for the second to last parcel to be developed on the entirety of Blocks A, B or C.

**Block F Urban Open Space (Civic Open Space):**

- » 1. Block F Urban Open Space shall be commenced upon the earlier of (A) two years from the date of the first Final Land Development Plan approval for the first parcel to be developed on Blocks D, E or G (the "Initial Trigger Date") or (B) approval of the first Final Land Development Plan for Block F.
- » 2. All improvements for the Block F Urban Open Space shall be completed in accordance with a phasing schedule approved by the Planning Commission as part of the FLDP for the Block F Urban Open Space. The Block F Urban Open Space shall be completed no later than the earlier of (A) nine calendar months following the Initial Trigger Date or (B) the issuance of the final occupancy permit for the last parcel to be developed on Block F.

**Block H Urban Open Space** shall be commenced upon the approval of the first Final Land Development Plan for development on Blocks G or H and shall be completed in accordance with a schedule that may be approved by the Planning Commission as part of the FLDP for Block H Urban Open Space. It is intended that Block H Urban Open Space be developed in conjunction with Block I and the CAP project (described in Section 7.2) and the schedule for Block H Urban Open Space shall take into consideration the schedule of the Block I CAP project development. Accordingly,

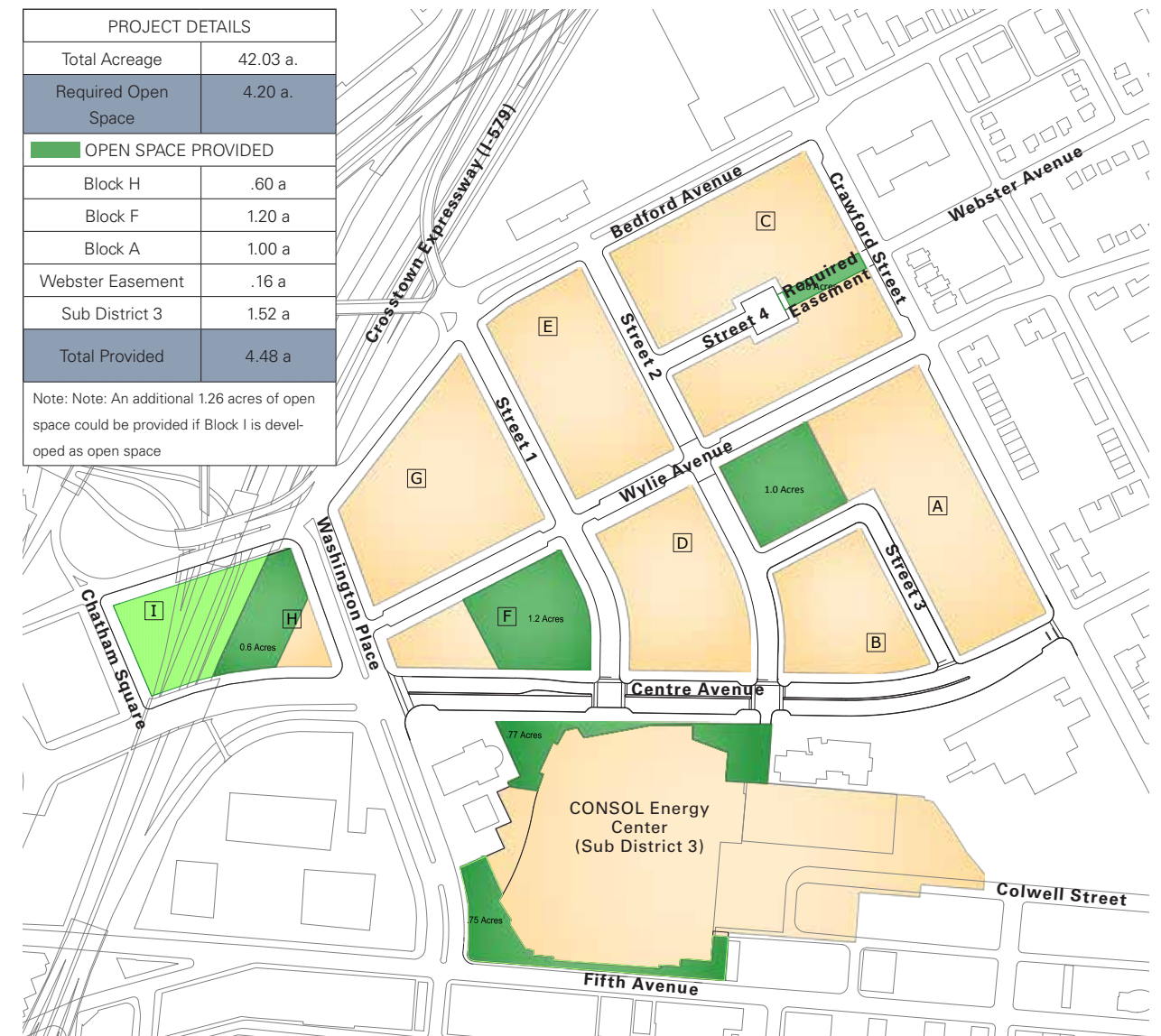

FIGURE 2.28 Urban Open Space and Courtyards Regulating Plan

the Planning Commission may delay the commencement of Block H Open Space based on the timing of the CAP project. Nevertheless, the development of Block H Urban Open Space shall be completed no later than the earlier of (i) issuance of the final occupancy permit for the last parcel to be developed of Blocks D, E, F, or G; or (ii) the issuance of the final occupancy permit for Block H.



## Sec. 2.7 Street Frontages

The intent of this PLDP is to create an urban neighborhood, therefore development should cover 100% of every block face with the exception of access drives, alleyways and pedestrian access points. Building setbacks are also intended to create an urban neighborhood, therefore commercial frontages shall have a zero setback and residential frontages shall have a modest setback to allow for some separation from the sidewalk. To establish these conditions, buildings shall comply with the designated Frontage Types.

Frontages govern basic parameters such as building placement and allowable condition between the building and the street (i.e.: terrace, yard, etc.). Six Street Frontage Types are identified that allow for a range of residential and commercial possibilities. Generally, the eastern development blocks are assigned with primarily residential types to integrate with the adjacent residential neighborhood. Closer to Downtown and adjacent to the CONSOL Energy Center, the western development blocks are assigned with more commercial street frontage types. All building types identified in Section 4.4 shall comply with Frontage Types set forth in Figure 2.29.

Additionally, some frontages are categorized as Primary Frontage (in orange). These are frontages along important streets, framing Urban Open Space, or along important view corridors where attention to the pedestrian realm is especially crucial. Requirements for Primary Frontages include:

- » Locate a prominent entrance on this facade versus a secondary frontage.
- » Even where allowed, curb cuts and driveways should be kept narrow and to a minimum.
- » Surface parking lots along primary frontages are not permitted. Structured parking on primary frontages shall have additional architectural requirements in order to complement the pedestrian realm (see parking types for more information in Section 2.9).

Those frontages not identified as primary are therefore considered Secondary Frontages and are not subject to additional requirements.

In the case that development blocks are subdivided, interior sideyard and rear yard conditions shall have a zero setback condition, except to accommodate green space, courtyards, or service areas. Rear and sideyard setbacks on alleys are minimum 0 feet and maximum 6 feet.



FIGURE 2.29 Street Frontages Regulating Plan



2.7.1 Frontage Types

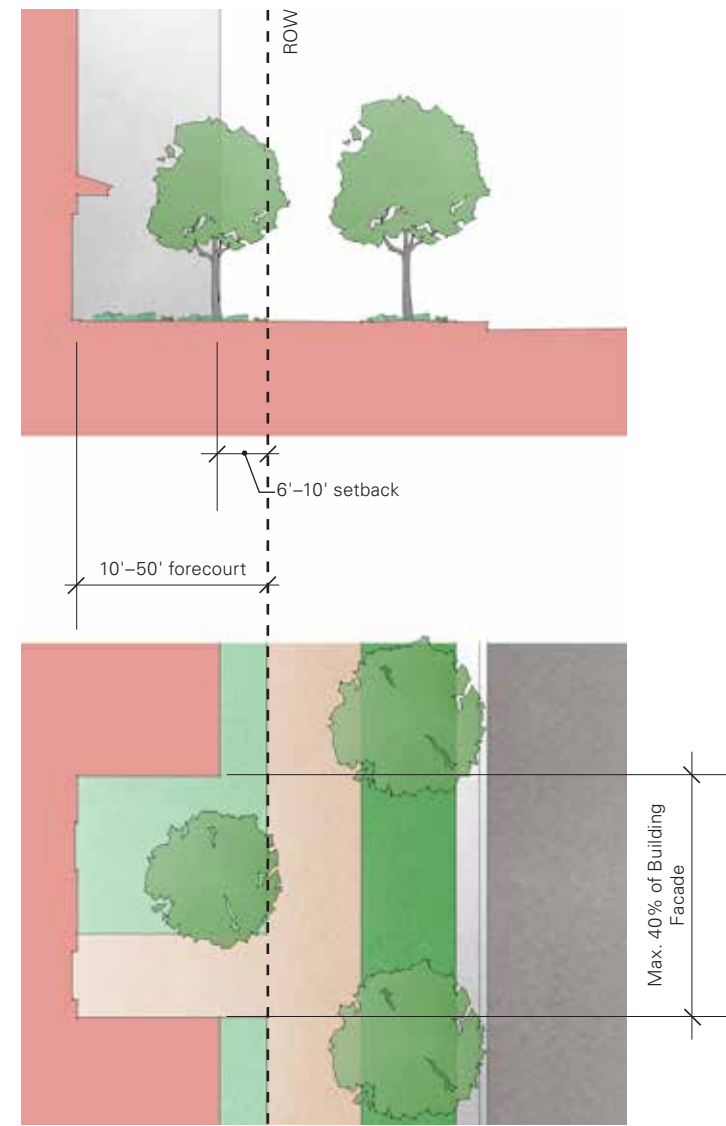
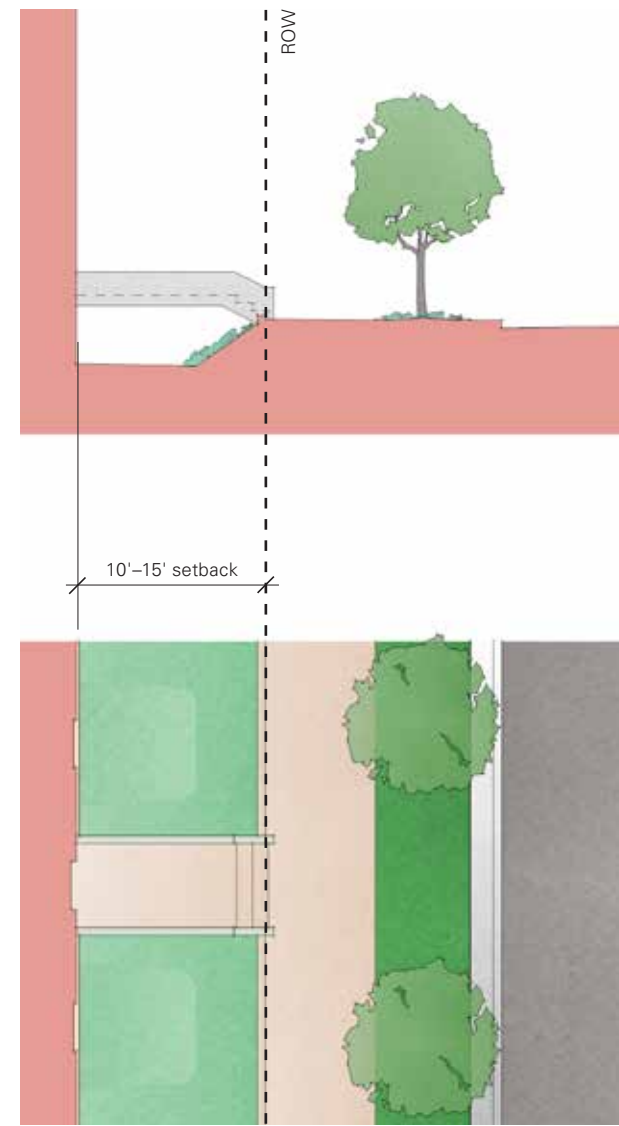
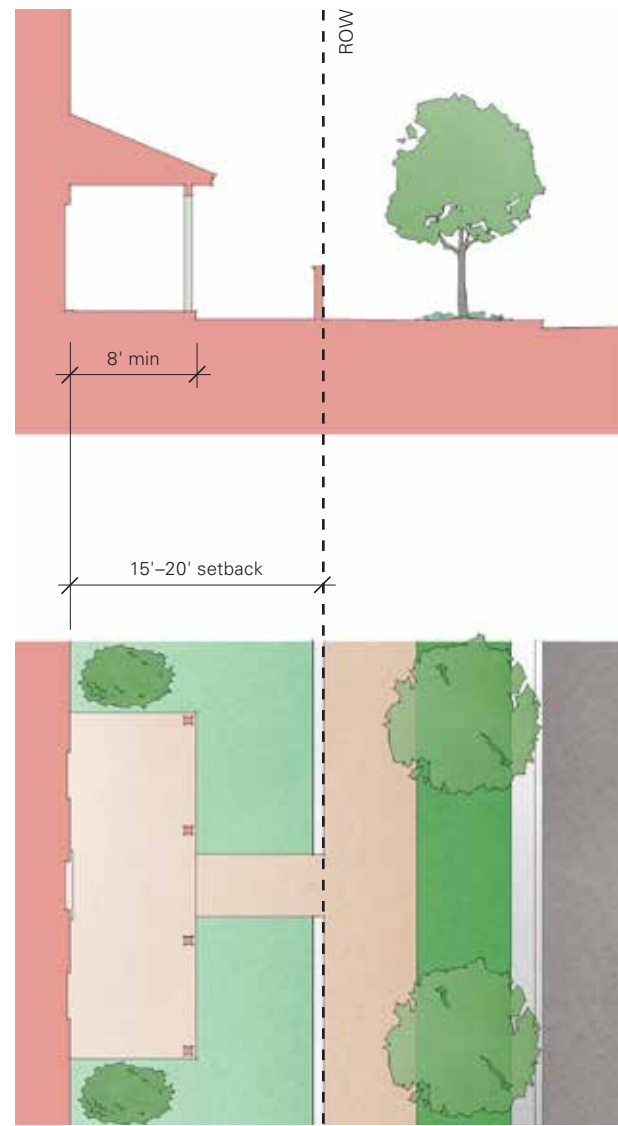

FIGURE 2.30 Frontage Type A

FIGURE 2.31 Frontage Type B

FIGURE 2.32 Frontage Type C

**(A) RESIDENTIAL FRONTAGE TYPE: PORCH AND FENCE**  
 A frontage where the facade is set back from the street ROW with an attached porch permitted to encroach in the setback. The porches shall be no less than 8 feet deep. A fence is permitted along the street ROW line (see section 6.7.1 for fence information). Required building setback: 15 feet minimum, 20 feet maximum.

**(B) RESIDENTIAL FRONTAGE TYPE: TERRACE OR LIGHT COURT**  
 The Lower Hill is a sloping site that will require grading along the street frontage to transition from sidewalks to buildings. This frontage permits an elevated terrace or sunken light court. This frontage buffers residential uses from urban sidewalks and removes the private yard from public encroachment. Required building setback: 10 feet minimum, 15 feet maximum.

**(C) RESIDENTIAL FRONTAGE TYPE: FORECOURT**  
 A frontage where a portion of the facade is set back a minimal amount and the central portion has a deeper set back. The forecourt created is suitable for front gardens and gathering spaces. Deeper and wider forecourts can accommodate vehicular drop-offs if required. Required building setback: 6 feet minimum, 10 feet maximum. Allowable forecourt setback: 30 feet for a landscaped residential forecourt, 50 feet maximum for a vehicular forecourt. Allowable forecourt width: maximum 40% of building facade.



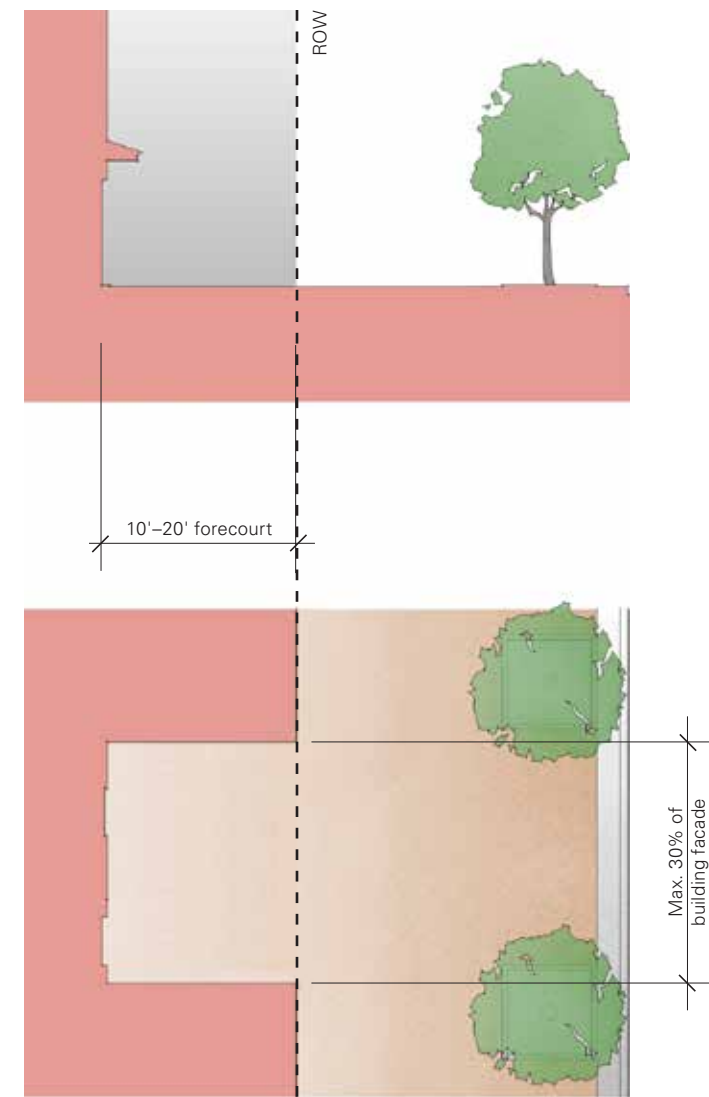
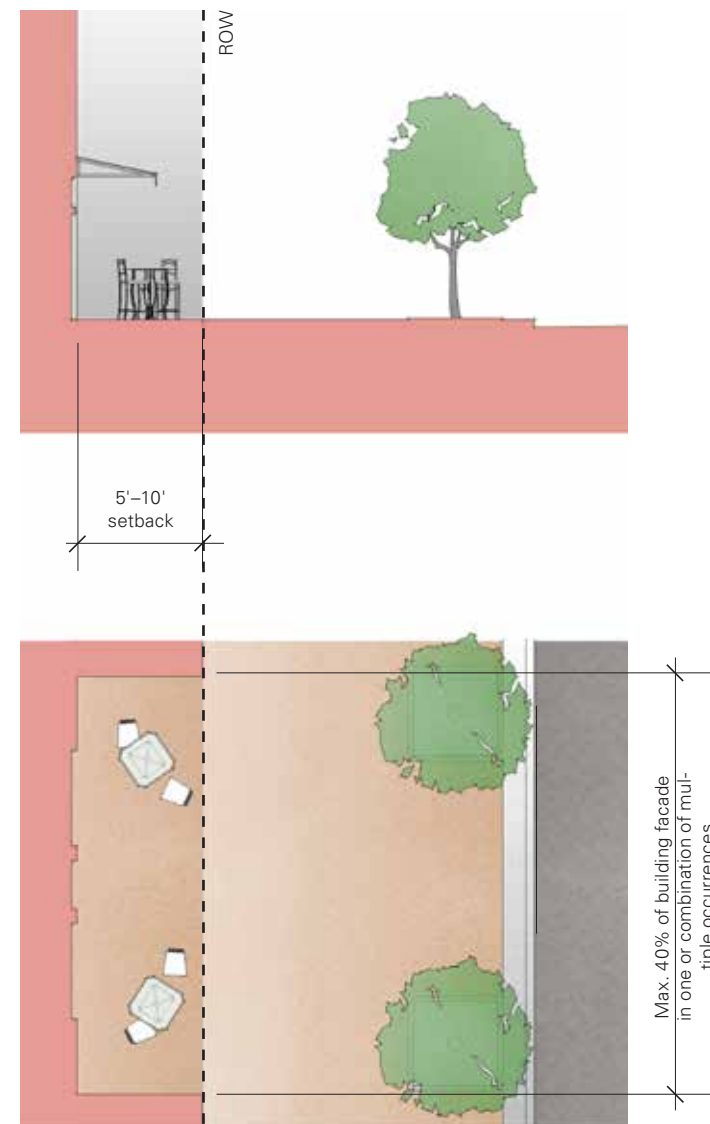
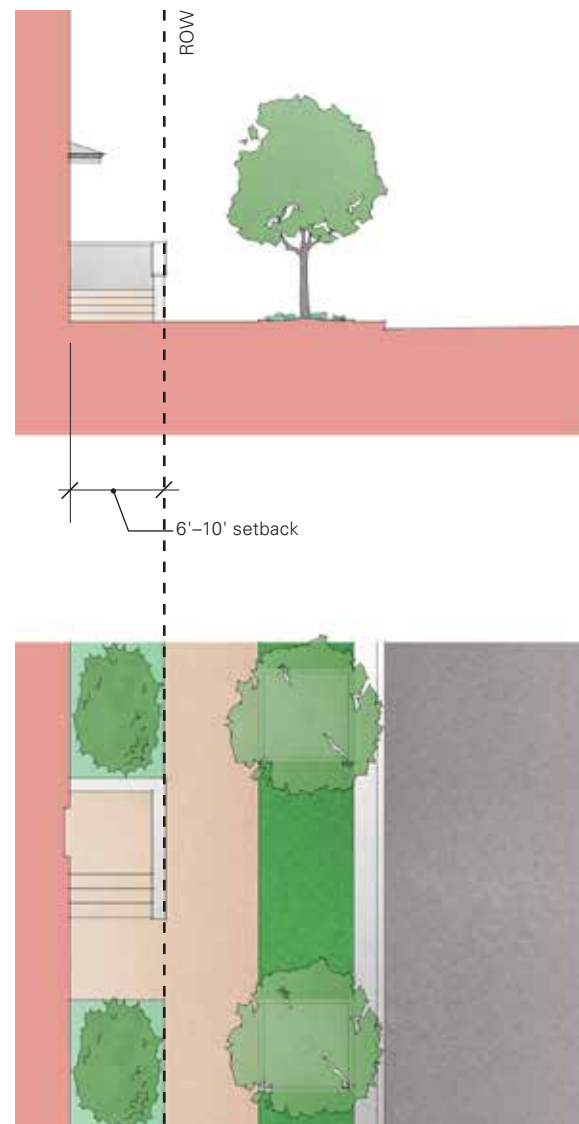

FIGURE 2.33 Frontage Type D

FIGURE 2.34 Frontage Type E

FIGURE 2.35 Frontage Type F

**Ⓓ RESIDENTIAL FRONTAGE TYPE: STOOP**

A frontage where the facade is setback from the street ROW with the first floor elevated from the sidewalk sufficiently to secure privacy for the windows. The entrance is usually an exterior stair and landing. Required building setback: 6 feet minimum, 10 feet maximum.

**Ⓔ COMMERCIAL FRONTAGE TYPE: TERRACE**

A frontage where the building is aligned with the street ROW and a portion is set back for building entrance or commercial activities. This type is conventional for retail use. The building must be placed on the right-of-way (0-foot setback). Allowable terrace setback: 5 feet minimum, 10 feet maximum. Allowable terrace width: maximum 40% of building facade.

**Ⓕ COMMERCIAL FRONTAGE TYPE: FORECOURT**

A frontage where a portion of the facade is set back a minimal amount and the central portion has a deeper set back. The forecourt created is suitable for front gardens and gathering spaces. Deeper and wider forecourts can accommodate vehicular drop-offs if required. The building must be placed on the right-of-way (0-foot setback). Allowable forecourt setback: 10 feet minimum, 20 feet maximum. Allowable forecourt width: maximum 30% of building facade.



**2.7.2 Frontage Type Applications**

The intent of the examples on the following pages is to provide clarification to the frontage types and their possible applications. These are not the only possible applications, but have been developed in anticipation of the most common scenarios.

Frontage types are used to define a desired character along a street face and are independent of the building type. Although building types are described later in the document, the frontage regulations are what will define the desired urban form of the new district.

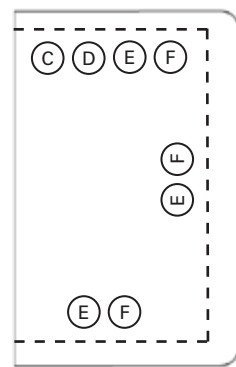

FIGURE 2.36  
Regulating Block Plan

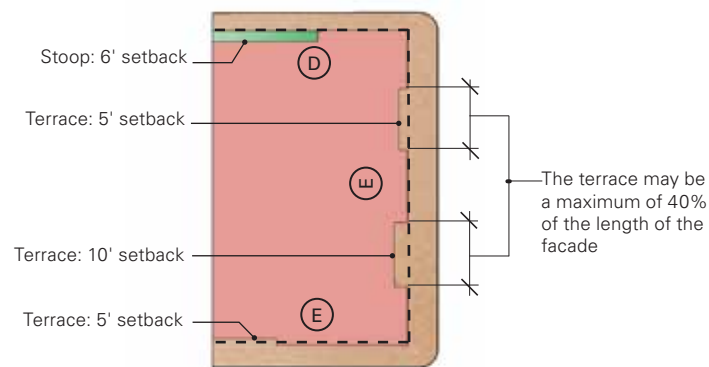

FIGURE 2.37  
Example: Typical One Building Application

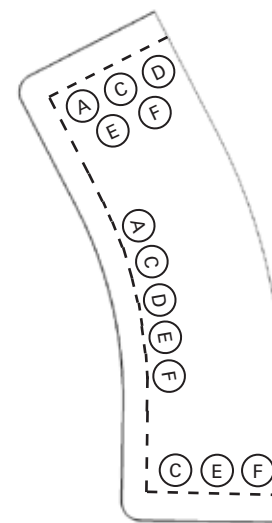

FIGURE 2.38  
Regulating Block Plan

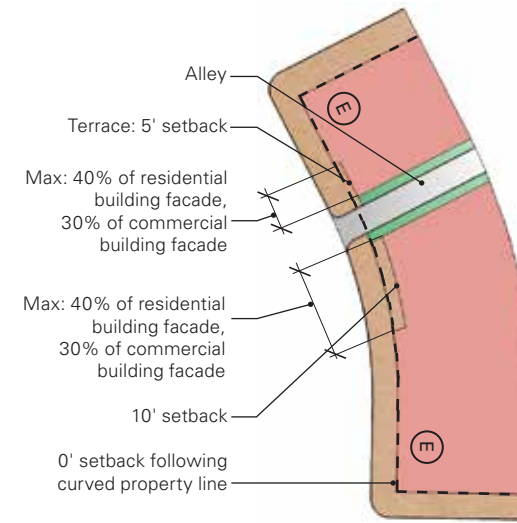

FIGURE 2.39  
Example A: Two Building Curved Frontage Application

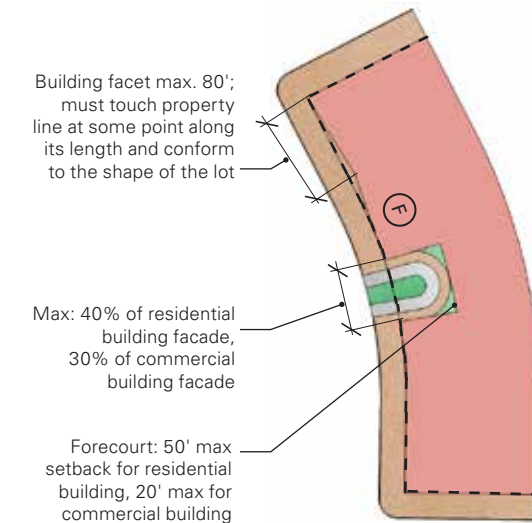

FIGURE 2.40  
Example B: One Building Faceted Frontage Application

**A. Example: Typical Frontage**

A typical application of Frontage Types D and E for a typical block can be found in the example diagram.

**B. Example: Curved Property Line Frontage**

Example A depicts a possible frontage condition using a building with a curving facade. However, in conditions where a property line or lot is curved, the building facade is not required to be curved. Example B depicts a condition allowing the facade to be faceted in segments of up to (80) eighty feet in length. Each segment must touch the property line in at least one point along its length, and the adjoining segment must do the same, thereby following the curve in a number of facets. The maximum divergence from ROW is 5 feet. The unoccupied space remaining between the building and property line must comply with the regulation of the frontage type. By doing this, the building will still be considered as having a (0) zero foot setback.



2.7.2 Frontage Types (continued)

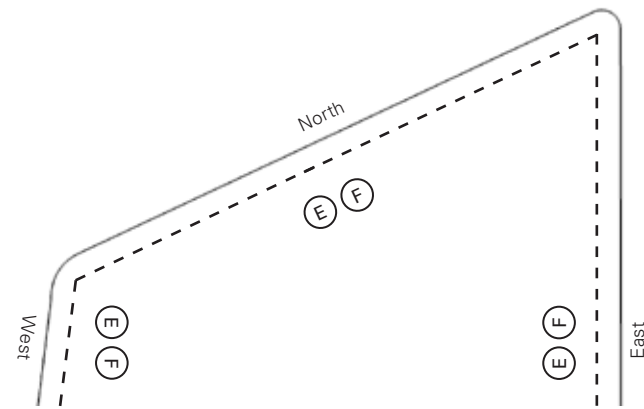

FIGURE 2.41  
Regulating Block Plan

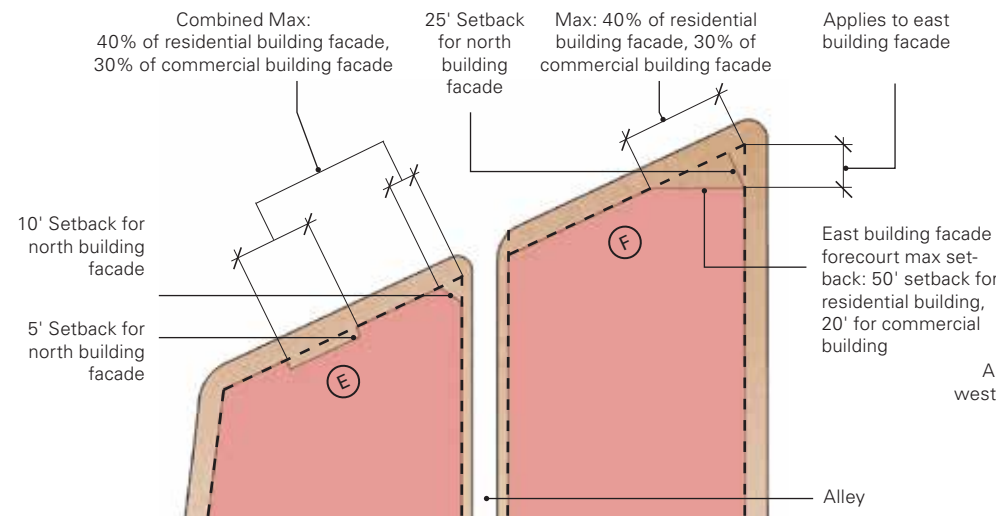

FIGURE 2.42  
Example A: Two Building Application

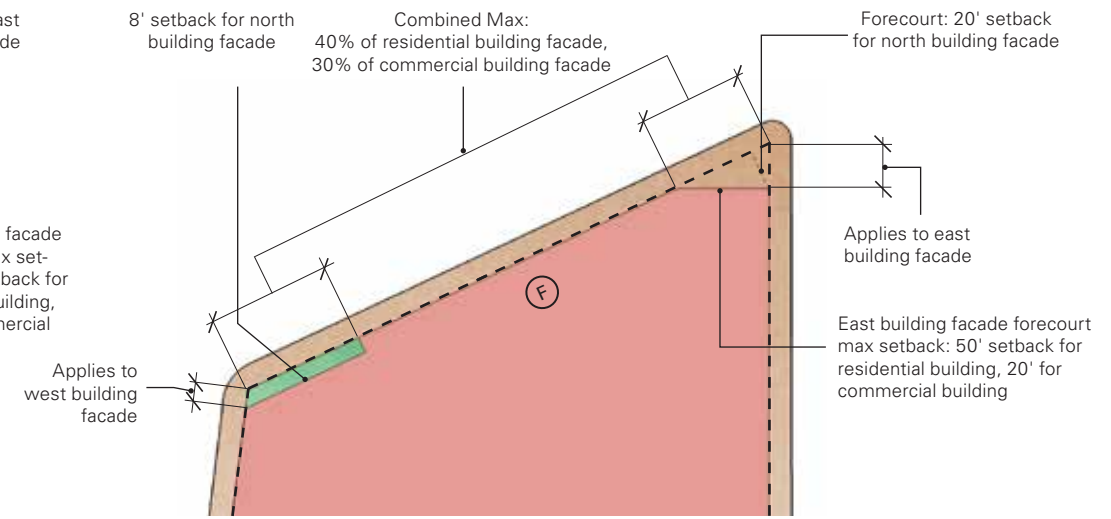

FIGURE 2.43  
Example B: One Building Application

C. Example: Non-Orthogonal Property Line Frontage

In conditions where property lines create an obtuse or acute angle, the standard frontage rules still apply. Examples A and B indicate two possible approaches to this condition.



**2.7.3 Frontage Types – Landscaping Requirements**

The following landscaping requirements correspond with the Frontage Types set forth in Section 2.7. Accordingly, a building’s Frontage Type (as determined in Section 2.7) corresponds to the applicable landscaping requirements for that Frontage Type set forth below.

The landscape of the public realm of the Lower Hill Site Redevelopment includes open spaces, streetscapes with street trees and planting pits, and the private front yard of commercial and residential buildings. These private front spaces are defined on the following pages and should consider both hardscape and softscape materials during design.



FIGURE 2.44 Typical commercial/residential frontage showing a recessed entry and walled garden beyond



FIGURE 2.45 Typical commercial/residential frontage showing a recessed, covered entry and garden planting



FIGURE 2.46 Typical commercial/residential frontage showing a recessed entry and with planters

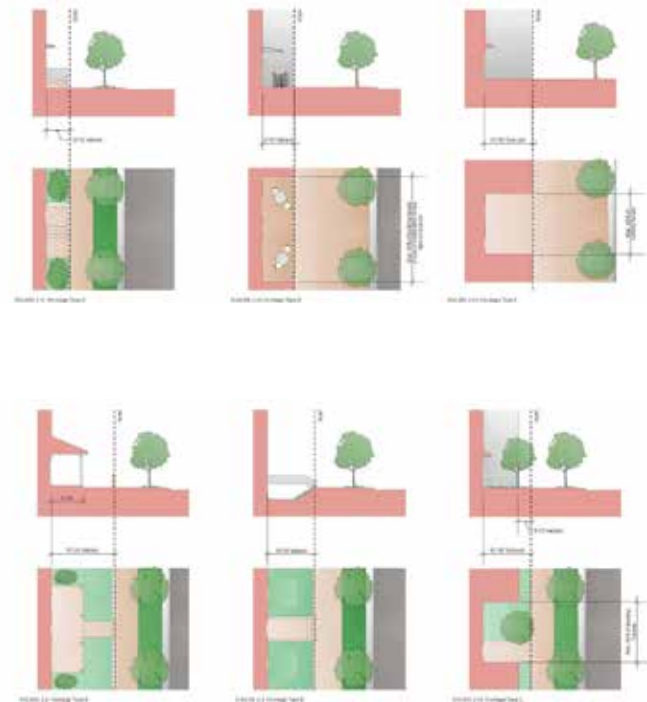

FIGURE 2.47 Typical residential frontage showing planting beds with fencing at edge of walks



FIGURE 2.48 Typical commercial/residential frontage showing recessed entry and covered outdoor seating. Overhang extends to setback line and helps building maintain the sidewalk edge.

© 2014 URBAN DESIGN ASSOCIATES



2.7.4 Residential Landscape

A. Residential Porch and Fence and Terrace or Light Court

Frontage Types characterized as “Residential Porch and Fence” or “Residential Terrace or Light Court” shall meet the following landscape criteria:

- » Walls, hedges, or fences shall be maximum 48 inches high (no chain link permitted) with an 18-inch planting strip between the outermost curb of the sidewalk and the wall, hedge or fence. Materials shall be compatible with the architecture of the building.
- » On corner parcels, extend a hedge, fence, or wall along the side property line from the main body of the building to the garage or rear property line.
- » A minimum of 2 canopy or understory trees required per 40 linear feet of building frontage. Such trees are required in addition to street trees and shall be placed on the development parcel and not within the right-of-way.
- » A minimum of 50% of the softscape areas shall be planted, 50% of which shall be deciduous or evergreen shrubs with the remainder a mixture of groundcovers and perennials. The use of native plants is required for all softscape areas.

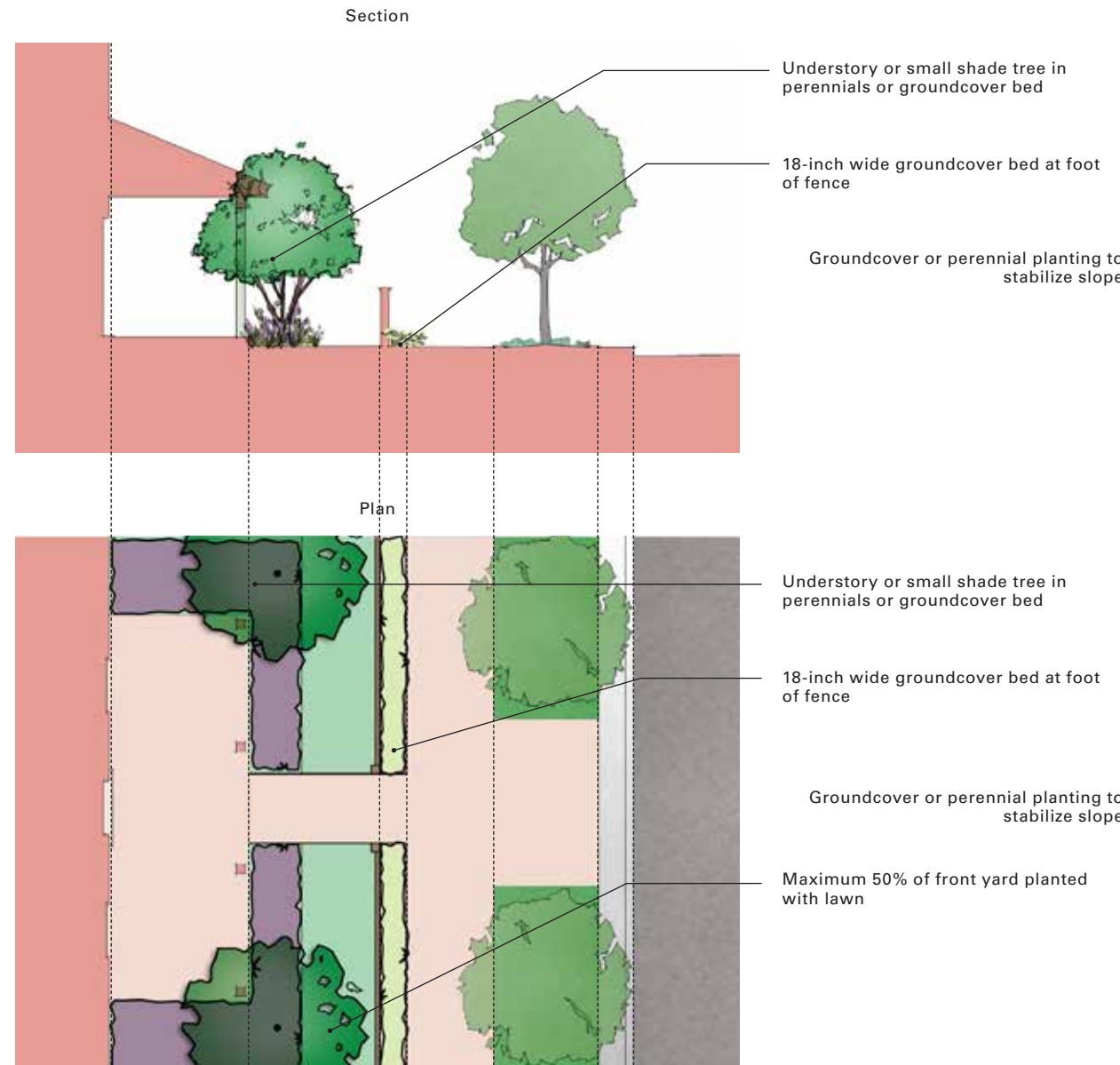

FIGURE 2.49 Typical residential frontage with fence showing proposed planting in plan and elevation

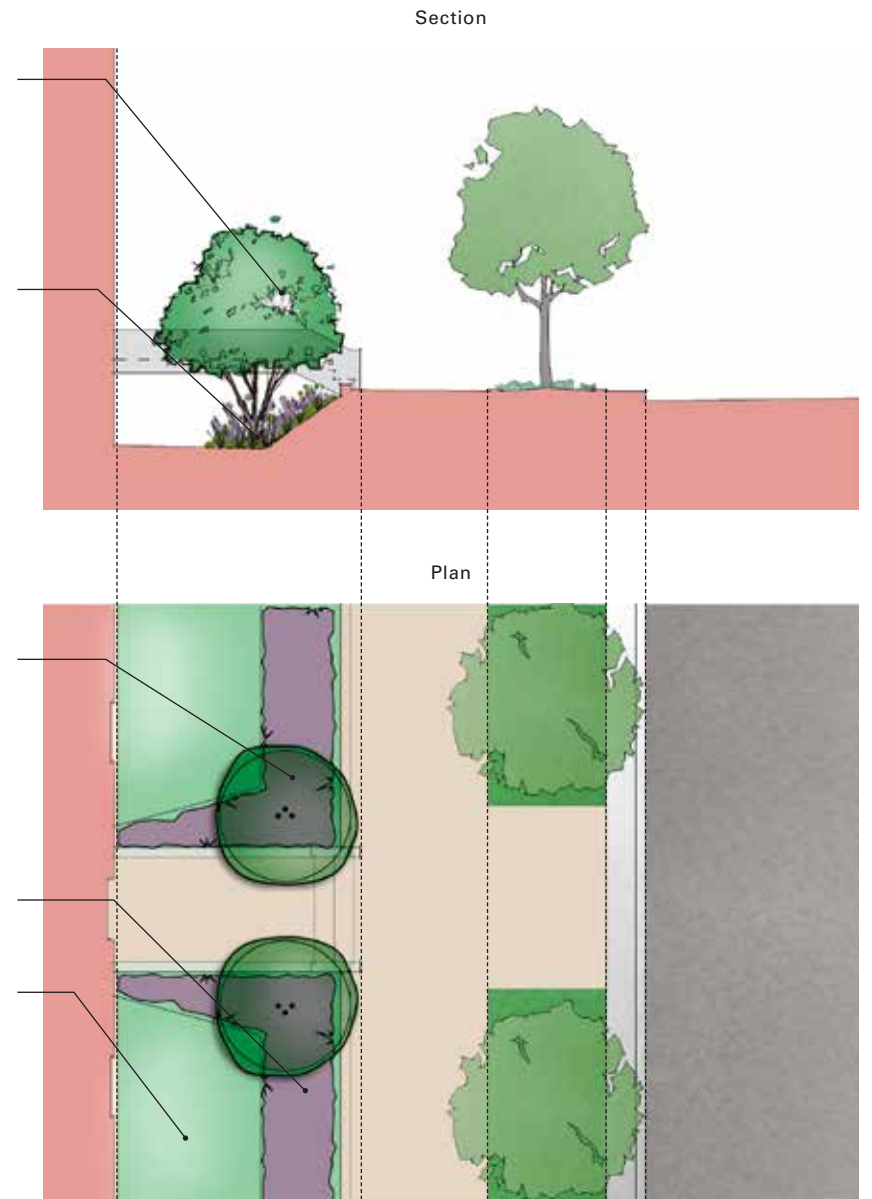

FIGURE 2.50 Typical residential frontage with light court showing proposed planting in plan and elevation



**B. Residential Forecourt and Stoop**

Frontage Types characterized as "Residential Forecourt" and "Stoop" shall meet the following landscape criteria:

- » Walls, hedges or fences shall be max 48 inches high (no chain link permitted) with an 18-inch planting strip between the outermost curb of the sidewalk and the wall, hedge or fence. Materials shall be compatible with the architecture of the building.
- » Where space and setbacks allow, the use of walls or fences for private gardens and courts shall be a maximum of 72 inches high with 40% transparency.
- » On corner parcels, a hedge, fence, or wall along the side property line shall extend from the main body of the building to the garage or rear property line.
- » A minimum of 2 canopy or understory trees shall be required per 40 linear feet of building frontage. Such trees are required in addition to street trees and shall be placed on the development parcel and not within the right-of-way.
- » All residential frontages shall incorporate native plants into the landscaping.

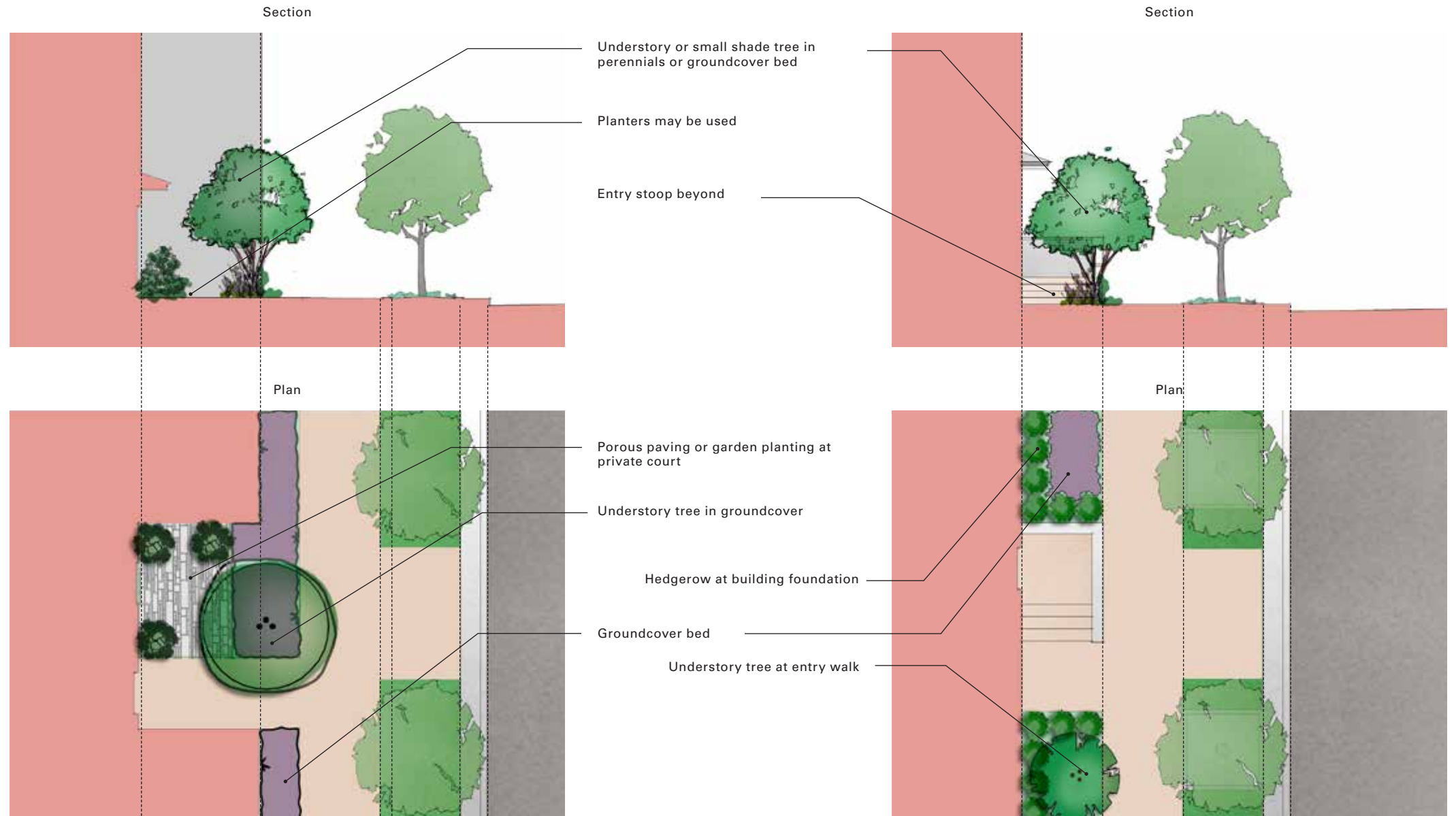

FIGURE 2.51 Typical residential frontage with forecourt showing proposed planting in plan and elevation

FIGURE 2.52 Typical residential frontage with stoop showing proposed planting in plan and elevation

© 2014 URBAN DESIGN ASSOCIATES



**C. Commercial At-Grade Terrace and Forecourt**

Frontage Types characterized as “Commercial At-Grade Terrace” or “Commercial Forecourt” shall meet the following landscape criteria:

- » Walls, hedges, or fences shall be maximum 48 inches high (no chain link permitted). Materials shall be compatible with the architecture of the building.
- » Where space and setbacks allow, the use of walls or fences for private gardens and courts shall be a maximum of 72 inches high with 40% transparency.
- » On corner parcels, a hedge /planters, fence, or wall along the side property line shall extend from the main body of the building to the rear property line in order to hold the corner.
- » If space permits, 50% of the plant material shall be deciduous or ever-green trees and shrubs with the remainder a mixture of groundcovers and perennials. All commercial landscaping shall incorporate native plants.
- » At grade terraces shall be defined by planters, walls, fences, or other vertical structure to define the private /public realm.\

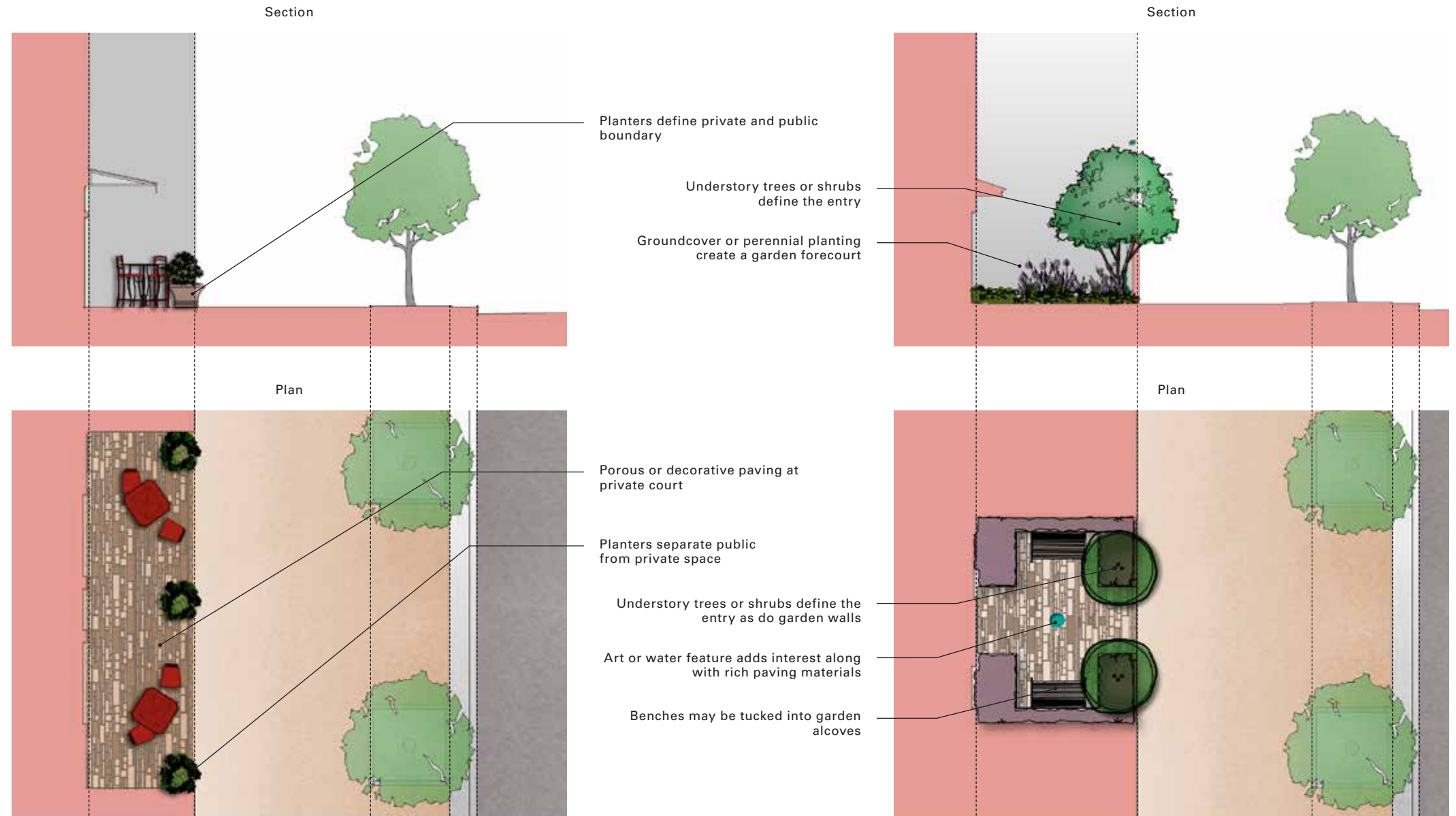

FIGURE 2.53 Typical commercial frontage with at grade terrace showing proposed planting in plan and elevation

FIGURE 2.54 Typical commercial frontage with forecourt showing proposed planting in plan and elevation



## Sec. 2.8 Building Height and View Corridor

To ensure a scale of development that successfully blends the scale and density of the Hill District to Downtown, Building Height limitations are established. Minimum and maximum heights are prescribed based on the existing context, the desired scale of development, and the width of streets. The height measurements are established from the level of grade along each particular street and are measured as prescribed in the Zoning Ordinance (see Section 925.07) and as set forth at Section 4.2.1 of this PLDP. All new buildings shall fall within this range. To preserve skyline views for the adjacent residential neighborhood to the east and to maximize views for new development, the tallest permitted building heights occur along the north and south edges of the site (Fig. 2.30).

Several locations within the plan are identified as vista terminus points. The buildings in these locations shall have an architectural treatment that will act to terminate important view corridors. This treatment can include, but is not limited to, towers, grand entries, bay projections, or other similar elements.

Analysis of the site and discussions with the community revealed the importance of height controls and view corridors. To address this issue, this PLDP establishes a view corridor to protect these critical views. Buildings within the view corridor are limited to a maximum height of 180 feet at the lower portion of the site nearest Washington Place and 50 feet at the uppermost edge of the site nearest Crawford Street. The view corridor consists of the central area of the site and is measured 150 ft. in from the existing perimeter streets (Bedford Ave. and Centre Ave.), which responds to the existing tall buildings at the corners of Bedford/Crawford and Crawford/Centre. Buildings outside the view corridor can be taller but are governed by the maximum heights described on the next page.

The view corridor is preserved by establishing a maximum height plane through the middle of the site. This plane is illustrated in three dimensions to the far right. Buildings within the view corridor will not exceed this height plane, thus preserving views from areas of the Hill District to the west of the site. The section below also illustrates that buildings will not exceed this plane as they step down the hill. The diagrams on the subsequent page provide additional detail on maximum and minimum heights throughout the Site. The building height regulations in Section 2.8.1 and in the SP-11 Zoning Text codify the view corridor.



FIGURE 2.55 Diagram of desired view corridor through the site. This view corridor is codified by the height limits described on the page that follows.

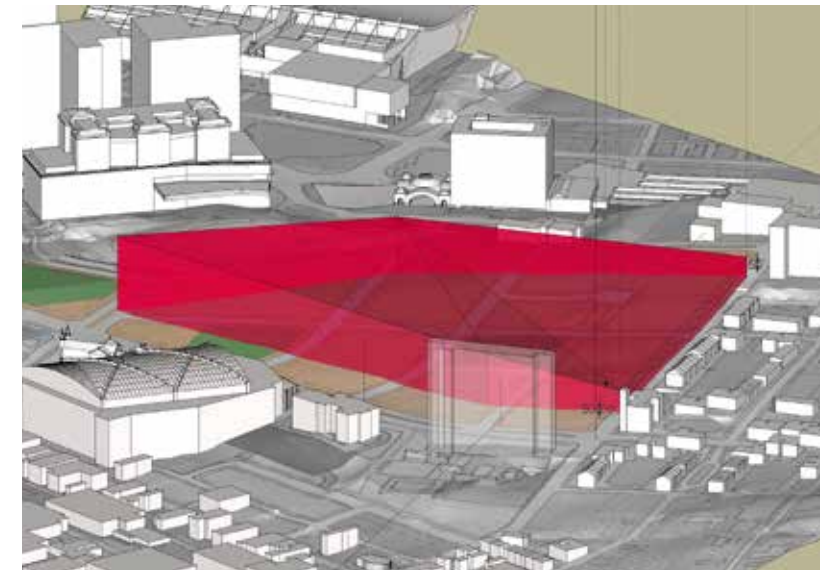

FIGURE 2.56 The height plane shown above is a result of codifying heights based on the desired view corridor. Buildings may not exceed the height plane at any given point.

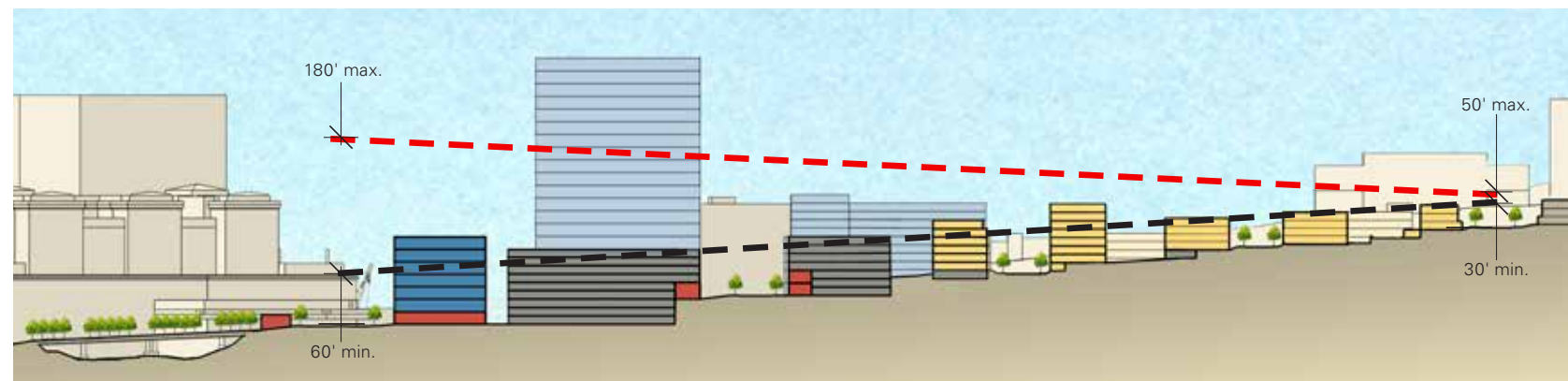

FIGURE 2.57 Conceptual Site Section: Red line indicates maximum building height within the site and green line indicates minimum building height. Each line is taken from center of Crawford Street to center of Washington Place. n to the left.



2.8.1 Building Height

Heights for new buildings are regulated by the diagrams shown above. These regulations were developed based on the existing context and the desire to respond to specific elements such as landmark buildings and the scale of the surrounding neighborhood. The page that follows illustrates how potential development scenarios relate to the established height plane.

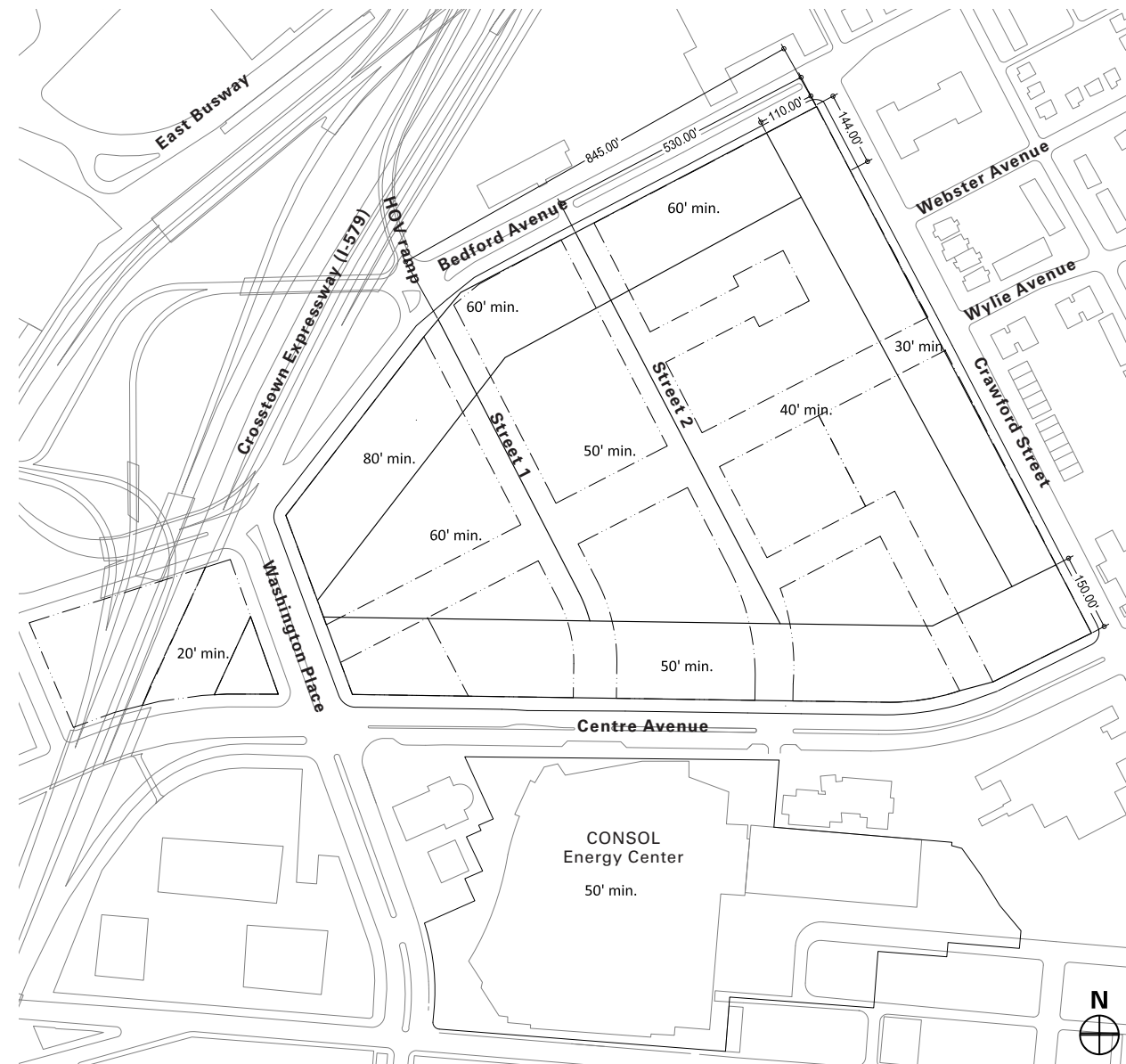

FIGURE 2.58 Minimum height requirements are based on the desired building scale appropriate to the street frontage they face on. Heights are provided for all areas of the site, including those areas currently designated as Urban Open Space, which allows for the possibility of future adjustments based on the actual development of the site. Note: accessory structures within open space have a 15-foot maximum height.



FIGURE 2.59 Maximum height requirements are derived from the height plane described in Figure 2.31 on the previous pages and respond to the immediate context. Heights are provided for all areas of the site, including those areas currently designated as Urban Open Space, which allows for the possibility of future adjustments based on the actual development of the Site. The chart to the right describes the minimum and maximum heights in each height zone.

HEIGHT ZONES	HEIGHT MIN.	HEIGHT RANGE (MAX.)
Zone a	30 FEET MIN.	50 FEET MAX.
Zone b	50 FT. MIN.	100 FT. MAX.
Zone c	40 FT. MIN.	70-100 FT. (SEE GRAPHIC)
Zone d	50 FT. MIN.	150 FT. MAX
Zone e	40 FT. MIN.	100-120 FT. (SEE GRAPHIC)
Zone f	50 FT. MIN.	160 FT. MAX.
Zone g	50 FT. MIN.	130-150 FT. (SEE GRAPHIC)
Zone h	50 FT. MIN.	110-130 FT. (SEE GRAPHIC)
Zone i	50 FT. MIN.	180 FT. MAX
Zone j	60 FT. MIN.	150 FT. MAX
Zone k	60 FT. MIN.	140-180 FT. (SEE GRAPHIC)
Zone l	80 FT. MIN.	UNLIMITED
Zone m	20 FT. MIN.	50 FT. MAX
Zone n	50 FT. MIN.	150 FT. MAX

© 2014 URBAN DESIGN ASSOCIATES



As described previously, the height envelope was derived by studying critical views from the Hill District. The images to the right illustrate varying scales of development along two primary streets, Centre Avenue and Wylie Avenue. The height plane is illustrated in the graphic below and regulated by the height minimums and maximums on the previous page. The intended result is development that transitions from a lower residential scale at Crawford Street, to a taller building scale at the edge of downtown. Key view corridors and landmarks, such as St. Benedict the Moor Church were important considerations when establishing this height envelope.



FIGURE 2.61 View of 50-foot height minimum along Centre Avenue.



FIGURE 2.62 View of the 100- to 180-foot maximum height along Centre Avenue.

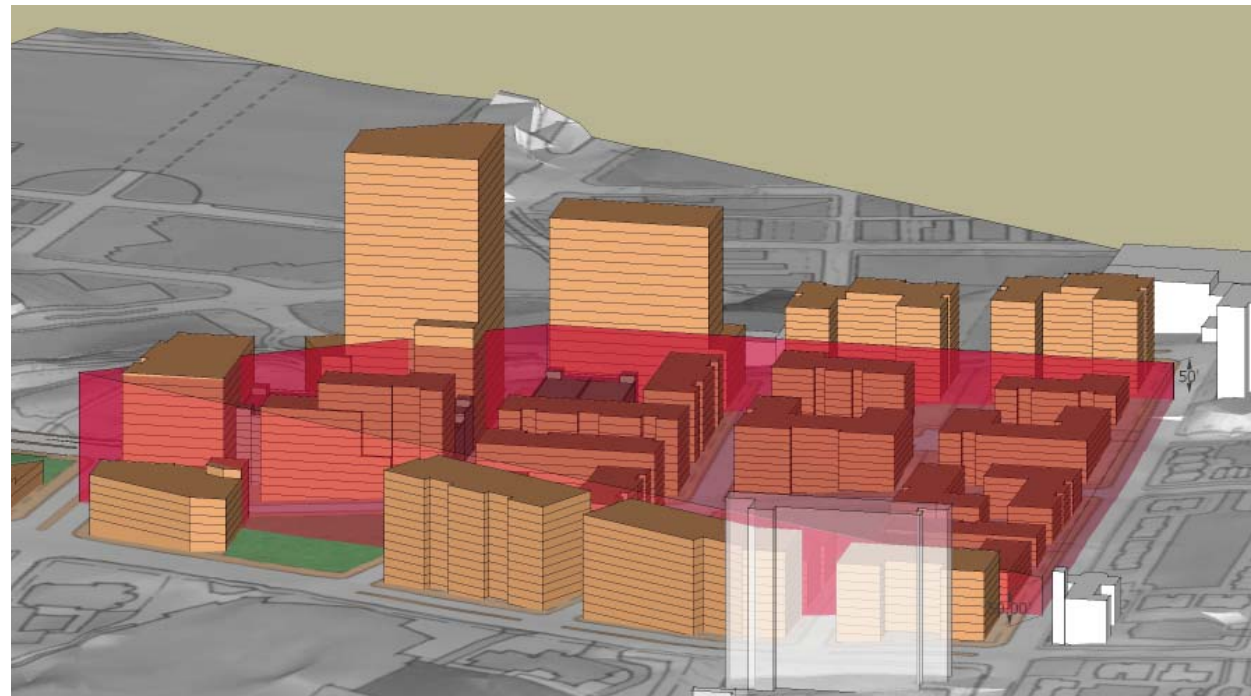

FIGURE 2.60 View illustrating a 50-foot maximum height along Crawford Street, and a 180-foot maximum height at Washington Place.



FIGURE 2.63 Potential view of Wylie Avenue towards Downtown illustrating transition in scale from the existing neighborhood (near corner of Mercer Street)

© 2014 URBAN DESIGN ASSOCIATES



## Sec. 2.9 Parking and Service

The Lower Hill is intended to be a mixed-use district that maximizes development frontage and places parking for short-term visitors, employees, and residents within the blocks and under buildings. The permitted types of parking in each development block and parallel parking conditions along each new street are indicated to the right. No parking is permitted on Block H due to access constraints at the intersection of Washington Place and Centre Avenue. The parking types are described in detail in Section 2.8.3.

Uses will have varying times of peak parking demand, thereby facilitating Multi-user Parking through the district. It is recommended that users share parking resources to make the most efficient use of parking resources.

On-street parking is to be provided throughout the plan. Street parking along Street 1, Street 2, Bedford Avenue, Crawford Street, and Centre Avenue, will be prohibited during CONSOL events so as not to adversely impact traffic flow. On-street parking spaces shall not count towards the parking requirements of any use on the site. To the extent residential buildings have dedicated parking for residents, such parking shall be located off-street, in garages or surface lots, provided such off street parking otherwise complies with this PLDP. Service areas such as loading zones and dumpsters shall be internal to the blocks (behind buildings) and accessed via private alleys. Service areas should be hidden from view of the street by being located beneath buildings, within garages, or screened by landscaping or buildings. No service doors or loading docks shall face onto the primary streets or green spaces. A cab stand should be located in a pedestrian accessible, centrally located location.

Curb cuts for driveways or private alleys shall be located at least 45 feet from street intersections (measured from perpendicular street curb line). Minimum distance between curb cuts shall be 25 feet. The permissible number of curb cuts along each street is regulated in Figure 2.37. Curb cuts may vary in width and can include both ingress and egress lanes within one curb cut. Where no indication is provided, no curb cuts are permitted. Note that there may be additional curb cuts along the Urban Open Space frontages specifically for service and access to the Urban Open Space. Curb cuts may be installed on an interim basis for surface parking lots prior to final development.

In the case that a block is subdivided into smaller development parcels, each parcel is permitted to have a minimum of one curb cut provided:

- » The curb cut is on a block frontage that currently allows curb cuts
- » No more than two additional curb cuts are added to the currently specified number along a particular block frontage; for Wylie Avenue between Crawford Street and Street 2, no more than one curb cut permitted
- » Minimum distance from an adjacent curb cuts is 25 feet (setback distance requirements from the intersection corner remain 45 feet)

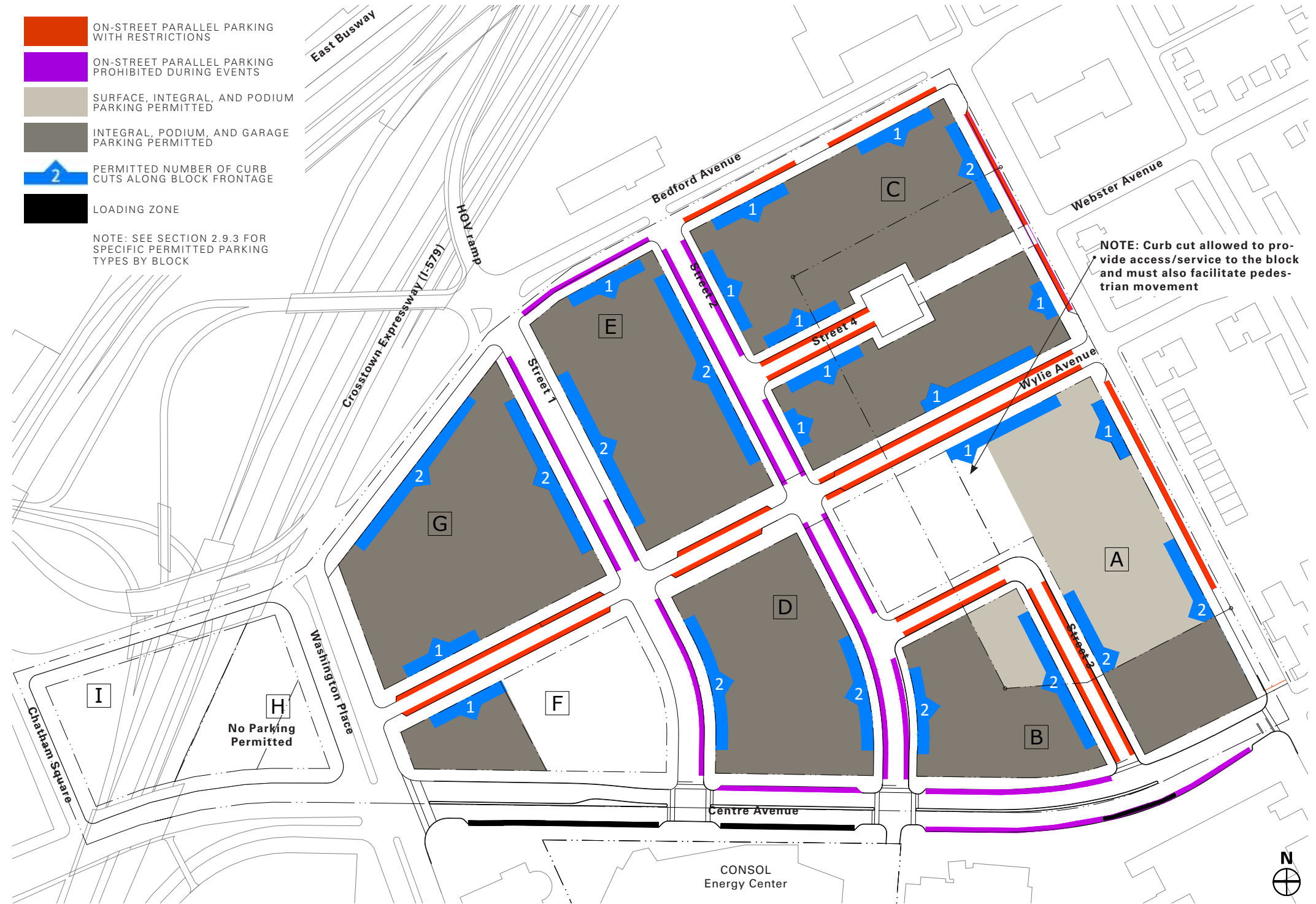

FIGURE 2.65 Parking and Service Regulating Plan



**2.9.1 Parking Ratios and Multi-User Parking**

**A. Parking Overview**

A multi-user parking strategy will be needed to make the most of the offstreet parking supply within and otherwise available to the Lower Hill Redevelopment Site. Parking Structures (as defined by the Zoning Ordinance) throughout the SP District are intended to be shared by multiple users and not solely as accessory parking to a principle use. As discussed below, certain Zoning Ordinance requirements applicable to this SP District are designed to achieve a district-wide multi-user parking strategy.

**B. Parking Exempt Area Designation**

In connection with the City’s adoption of the SP-11 Zoning Text, the SP District is designated as a “Parking Exempt Area” under Section 914.04 of the City of Pittsburgh Zoning Ordinance. The purpose of this designation is to allow for flexibility in development requirements by permitting the otherwise mandatory minimum parking requirements set forth in Section 914.02 of the Zoning Ordinance to be reduced to zero within the SP District. This strategy is intended to promote multi-user parking throughout the site as well as reliance on alternate modes of transportation and other reservoirs of parking within the City that may be appropriate to support proposed developments.

**C. SP District Parking Regulations**

In addition to the SP District’s designation as a Parking Exempt Area, the zoning text for the SP-11 District sets forth the following regulations:

- » Surface parking is permitted only in Sub-District 1 if it is accessory to residential use. All other off-street parking throughout the SP District is intended to be structured parking.
- » Off-street parking designated to a single use is permitted to have parking spaces up to the applicable minimum parking ratio set forth in Section 914.02 of the Zoning Ordinance.
- » Any user desiring to exceed the applicable minimum parking ratio must obtain special exception approval from the Pittsburgh Zoning Board of Adjustment and must demonstrate why multi-user off-street parking is not suitable for the proposed use.
- » The limitations on the number of parking spaces do not apply to Parking Structures (as defined by the Zoning Code) provided the that parking spaces are shared by multiple users and not solely as accessory parking to a principle use.

**D. Continued Tracking of Parking Availability**

As required at Section 922.11.C.2 pertaining to review of a Final Land Development Plan, each proposed development must adequately address traffic generation and parking, including a demand analysis, and must make provisions for adequate vehicle access and loading facilities. The demand analysis shall include (1) an analysis of the location and number of existing off-street parking spaces within the SP District, (2) to the extent available,

data regarding the usage of such existing parking spaces, (3) an analysis of other available parking (and transportation) in the City that could adequately serve the parking needs of the development, and (4) an analysis of other off-street parking areas available within walking distance of the Lower Hill Redevelopment Site. For purposes of a demand analysis, walking distance will be determined depending upon the uses that need to be served by the proposed development as well as the uses served by other developments within the SP District. In addition to the above requirements, each Final Land Development Plan shall identify the location of parking spaces sufficient to meet with applicant’s or end user’s needs as identified in the demand analysis.

**2.9.2 How Parking is Regulated**

Four vehicular Permitted Parking Types are established for use in the Lower Hill Redevelopment Site: Surface Parking Lots (for Sub District 1 only), Integral Parking, Podium Parking, and Parking Garage. The following pages provide detailed information about each Permitted Parking Type. Upon generating the parking load for a particular project area, a parking type should be selected and implemented as described.

The design of parking lots and structures are regulated in the following ways:

**A. Location on Block**

- » Location: indicates location of where parking occurs on a development block and how it must address the adjacent right-of-way (refer to Figure 2.29).

**B. Screening and Visibility**

- » Minimum level of screening required parallel to a street right-of-way:
- » Indicates the type of screening required of facilities depending on its location within the site.
- » Shade trees and parking lot landscaping shall be distributed around the lot as desired to intensify screening or create a landscape feature.

**C. Permitted Blocks**

- » Indicates in which Blocks that the parking type is permitted.
- » Note: Underground parking can occur on any block.

**D. LEED-ND**

- » Bicycle parking shall be provided as required by Section 914.05 of the Zoning Ordinance or as required to obtain LEED-ND certification (whichever provision requiring the most bicycle parking being applicable). In addition, electric vehicle charging stations and other such amenities may be required as part of LEED-ND certification.



FIGURE 2.66 An example of layered landscape screening along a surface lot



FIGURE 2.69 Example of a garage facade that is designed as if it were a building facade.



FIGURE 2.67 When facing the interior of a block, podium or garage parking may be screened by landscape in place of an architectural facade. In this example, a layering of sidewalk, landscape and benches create an effective and attractive screen



FIGURE 2.70 Examples of varying ways to treat parking garage facades along the street. Often corner elements may be emphasized as circulation locations.



FIGURE 2.68 Example of podium parking where parking is entered off the street, and residential uses are stacked above the parking. Note how the architectural treatment of the building disguises the parking.



FIGURE 2.71 Example of a parking garage with conditioned spaces lining the end and ground floor.



2.9.3 PERMITTED PARKING TYPES

The Pittsburgh zoning code recognizes surface and structured parking types. The following further details these types and ascribes development standards and appropriate locations for their development.

A. Surface Parking Lots

- » Permanent surface parking lots are only permitted in the interior of blocks for residential uses within Sub District 1 and, with restrictions, to the sides of buildings. Surface lots shall be no wider than 100 feet and shall be screened by low walls, fences, or landscaping in accordance with Zoning Code (See Section 918.03).
- » Permeable materials are recommended for parking lots whenever possible.
- » Permanent surface parking is prohibited on corner parcels unless screened by a building with active uses.
- » Permanent surface parking must be accessory to residential uses within the same parcel or block.
- » Where possible, surface lots should be accessed from private alleys versus dedicated access drives to reduce the need for curb cuts.
- » Surface Parking shall require additional screening beyond the standards of Section 918.03 of the Zoning Code if located adjacent to or visible from an Urban Open Space.



B. Integral Parking Requirements

- Integral parking occurs in buildings where enclosed parking is desired underneath a building and associated with a specific residential unit (commonly referred to as 'tuck-under'). Integral parking facilities are not permitted to be visible or accessible from the addressing street. Parking shall be accessed from only an alley or interior of the block. Along corners or secondary streets, the parking shall be screened by low walls, fences, or landscaping.
- » Buildings incorporating integral parking shall either be 5 feet from the rear property line (to allow for utilities and standing area outside of door) or minimum of 18 feet but nothing in-between (so that a parked car is not blocking the private alley). Integral parking can also be used as an approach when there is a parking court in the middle of a block (as shown in the graphic above)
  - » Individual residential unit garage entries shall not enter onto any street type other than a private alley.



C. Podium Parking Requirements

- Podium parking may be used in locations where either topography or density encourages siting parking beneath one or more buildings. Podium parking is intended to have minimal facade exposure along street frontages where permitted except at vehicular entry points and is encouraged to be lined with an active use. The top of the podium parking that is not occupied by a building should be treated as a courtyard with landscaped areas so as to provide an amenity to residents and the work force of the block. This landscape space should contribute to stormwater capture, retention and filtration. The following additional regulations apply to podium parking:
- » Any exposed facade five feet above grade (which is not lined by an active use) shall be designed and constructed with an articulated facade consistent with the architectural character of the surrounding buildings (plane breaks, material changes and roof lines) and containing clearly defined openings resembling window or door compositions.
  - » Any exposed facade that is not required to be articulated as set forth above, shall be screened by low walls, fences, or landscaping in accordance with Section 918.03 of the Zoning Code.
  - » Any exposed facade that is not required to be articulated as set forth above and which is adjacent to or visible from Urban Open Space shall require additional screening beyond the standards of Section 918.03 of the Zoning Code

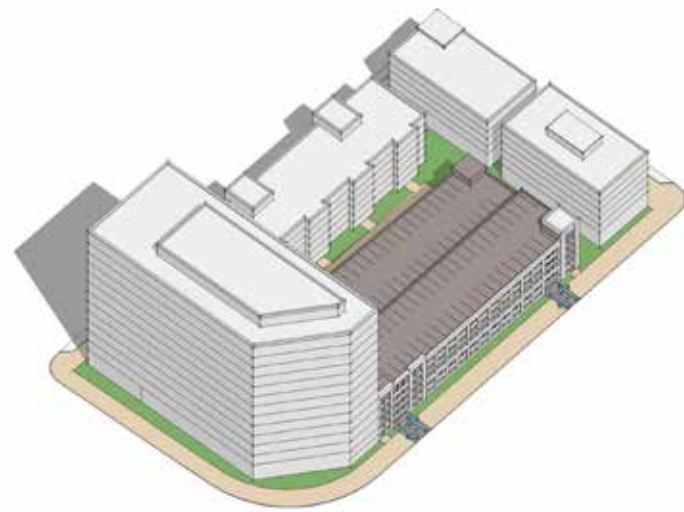

TABLE 2.1 Surface Parking Lot Requirements	
Location On Block	
Location	Interior of block or to side of building
Minimum setback from a street right-of-way.	30 ft
Screening and Visibility	
Minimum level of screening required parallel to a street right-of-way	Low wall, fencing or landscaping
Permitted Blocks (Sub District 1 only)	A, C

TABLE 2.2 Integral Parking Requirements	
Location On Block	
Location	Facing interior of block
Minimum setback from a street right-of-way (feet)	20 ft
Screening and Visibility	
Minimum level of screening required parallel to a street right-of-way	Conditioned Space
Permitted Blocks	A, B, C, D, E

TABLE 2.3 Podium Parking Requirements	
Location On Block	
Location	Below grade
Minimum setback from a street right-of-way (feet)	0 ft
Screening and Visibility	
Maximum unarticulated facade of a garage that may be exposed above grade (where it is not lined by active use)	5 ft
Permitted Blocks	A, B, C, D, E, F, G





**D. Parking Garage Requirements**

Parking garages must follow requirements established by the building heights regulating plan and shall otherwise comply with all building articulation requirements. The following regulations apply to garage parking:

- » Parking garages shall be given an architecturally articulated street facade with clearly defined openings.
- » When not lined by an active use, garage facades shall be designed and constructed with an articulated facade consistent with the surrounding buildings (including plane breaks, material changes and roof lines) and containing clearly defined openings resembling window or door compositions.
- » Parking garages that abut or have frontage facing Urban Open Space or Wylie Avenue and Centre Ave. shall be lined by an active use at ground level.

- » Bicycle and multi-user vehicle parking shall be provided to comply with LEED-ND and LEED-NC (if applicable) requirements.
- » It is recommended that a commercial use may line the garage on street-facing facades.
- » Garage structures shall not have frontage along Crawford Street unless the garage is lined by an active use on all levels. However, a garage entrance may be located on Crawford where curbcuts are otherwise permitted.
- » Parking garage facades are also subject to existing Zoning Code regulations, including Section 914.09.G.3.

TABLE 2.4 Parking Garage Building Requirements

Location On Block	
Location	Center of the block
Minimum setback from a Street right-of-way (feet)	0
Permitted Blocks	B, D, E, G



**E. Bicycle Parking**

Bicycle parking is required as set forth above and is otherwise encouraged throughout the site and shall be evaluated based on the following standards in addition to otherwise applicable zoning code and LEED-ND requirements:

- » Bicycle parking and location allocation shall meet LEED-ND requirements.
- » At a minimum, bicycle parking shall be located at all open spaces, near bus stops, and on the premises of all public or semi-public uses.
- » Bicycle racks shall not position bicycles in a manner that obstructs a minimum 5-foot clearance along walks.
- » Provide for bike corrals within Parking Lanes following the City of Pittsburgh's standards.

**F. Electric Vehicle Charging**

Electric vehicle charging stations are recommended in garages.

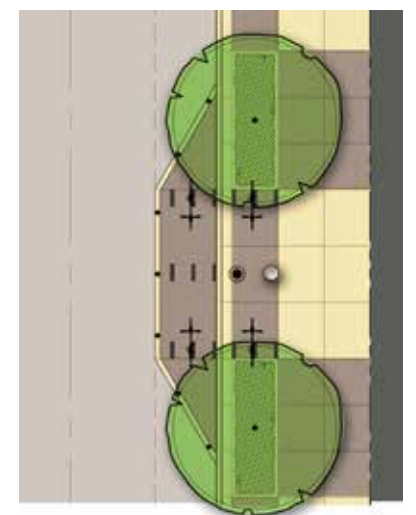
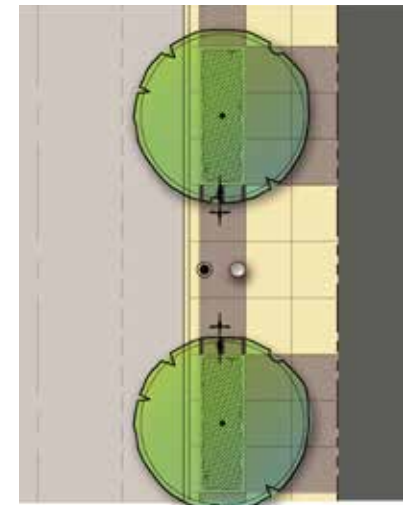

© 2014 URBAN DESIGN ASSOCIATES



## Sec. 2.10 Sub District 3

Sub District 3 includes the existing CONSOL Energy Center, its loading and service area, and adjoining parking garage. The Sub-District is subject to the Master Development Plan approved by the City of Pittsburgh Planning Commission on January 14, 2008 and Project Development Plan No. 0812 approved by the Planning Commission on May 6, 2008. In the event of future additions or reconstruction of all or portions of the structures, the regulating plans presented here are intended to regulate development.

### 2.10.1 Block, Urban Open Space, and Pedestrian Connections

The developable area for Sub District 3 is predetermined by the 2008 Master Development Plan (MDP) and essentially envelops the CONSOL Energy Center, its loading and service area, and adjoining parking garage. Urban Open Space is in excess of the required 10% and this PLDP reserves the right to reduce the open space to the required 10%. As part of the MDP approval, a pedestrian connection was provided from the CONSOL garage entrance on Centre Avenue to Stevenson Street. In the event funding is identified, the garden passage pedestrian connection (Curtain Call Project) shall also be provided.

### 2.10.2 Street Frontages

Street frontage types for future buildings are designated as set forth in Section 2.5 for Sub Districts 2 and 3. No street frontage types are designated for frontages that are considered internal and not facing primary streets.

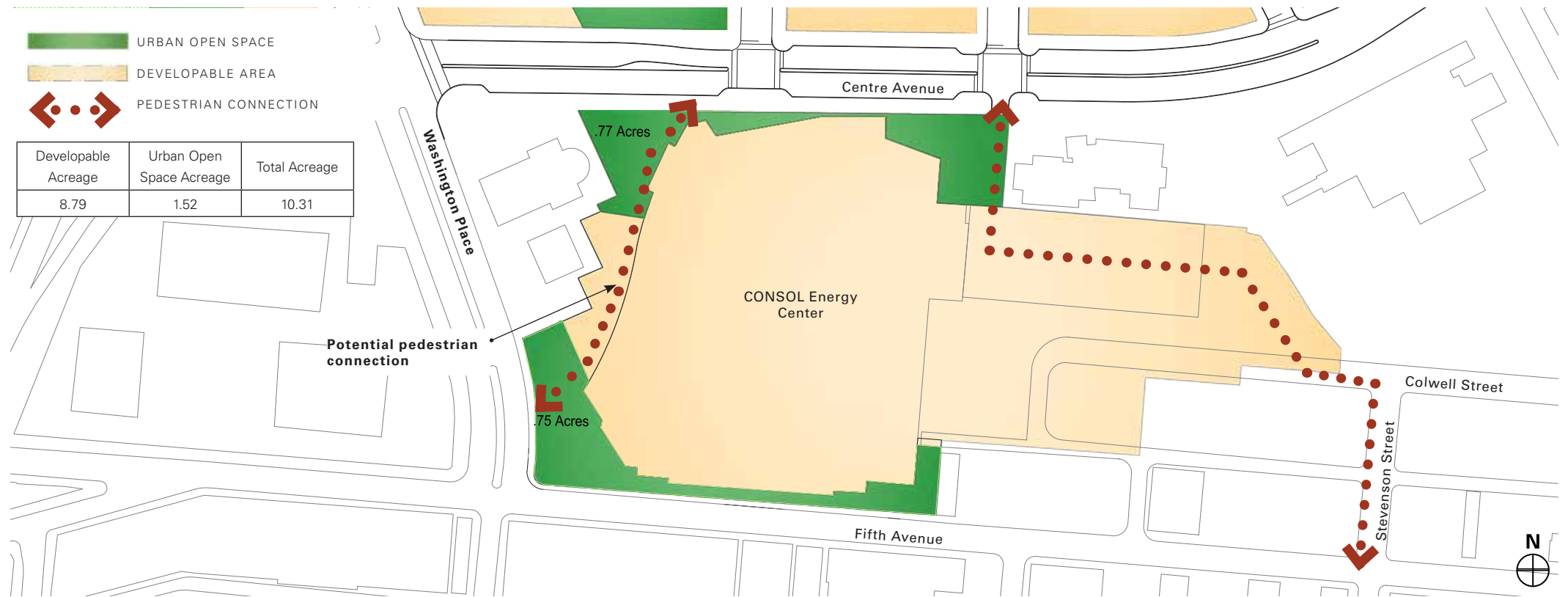

FIGURE 2.72 Block, Urban Open Space, and Pedestrian Connections Regulating Plan



FIGURE 2.73 Street Frontages Regulating Plan



**2.10.3 Building Height**

Building height limitations are established in Section 2.8 of the PLDP.

**2.10.4 Parking and Service**

Parking and Service regulations are assigned, and must follow those established for Sub Districts 2 and 3. Refer to Section 2.6 for further information. No curb cuts are assigned to the perimeter of the site facing primary streets beyond the existing entrance to the existing garage attached to the CONSOL Energy Center. Modified on-street parking for the southern side of Centre Avenue is discussed in Section 2.9. On-street parking along Fifth Avenue remains as it is today, prohibited during events.

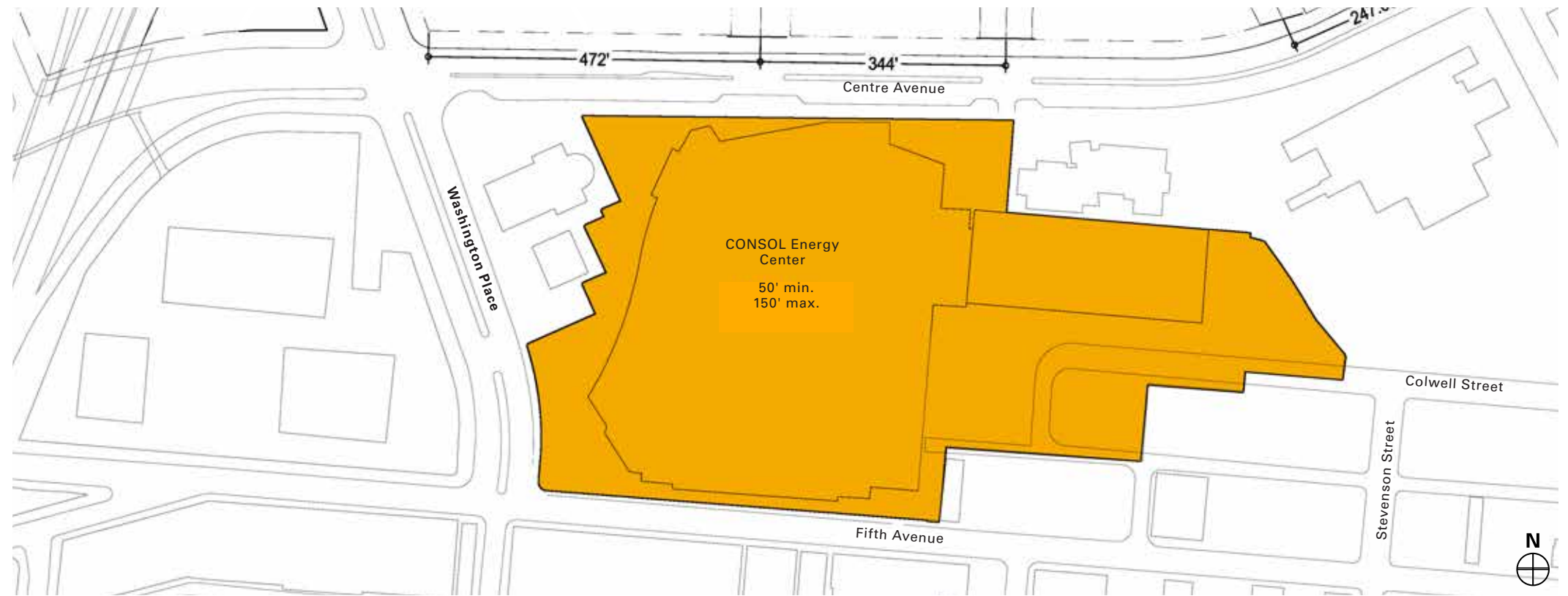

FIGURE 2.74 Building Height Regulating Plan

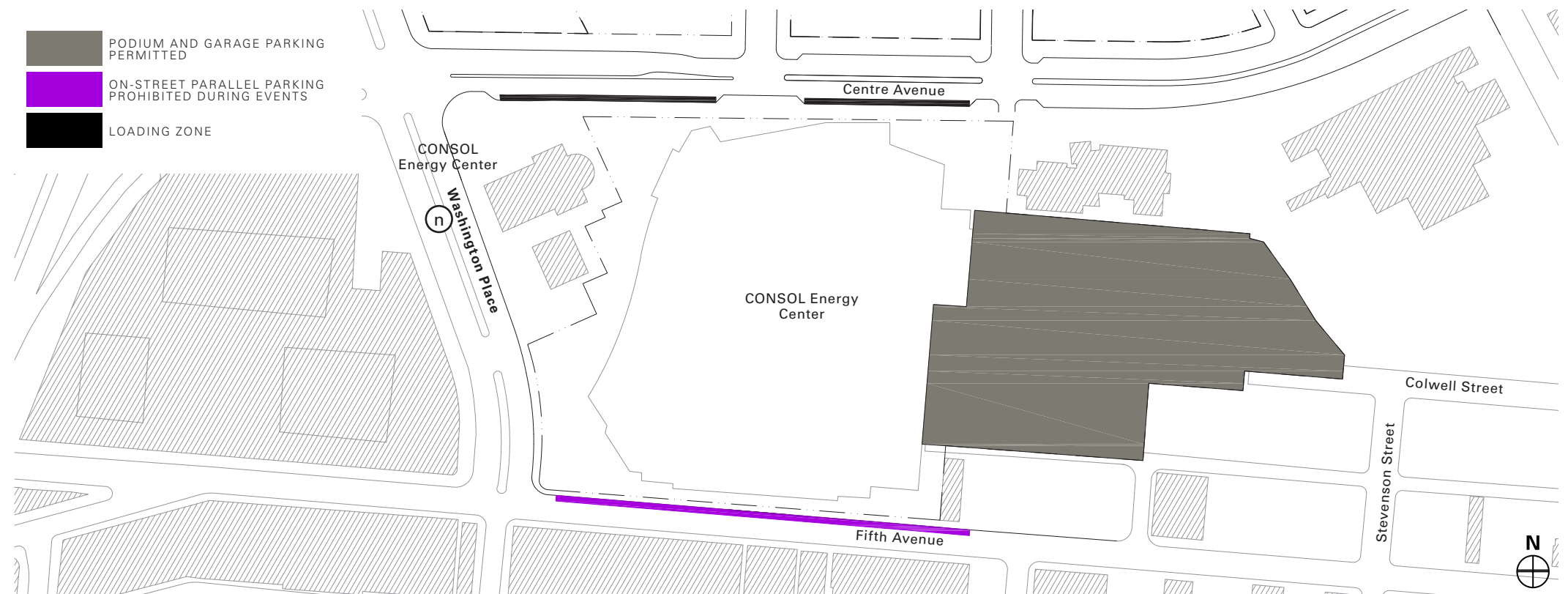

FIGURE 2.75 Parking and Service Regulating Plan



## Section 3. Street Types

Sec. 3.1 Introduction	38
Sec. 3.2 Street Type A	39
Sec. 3.3 Street Type B	40
Sec. 3.4 Street Type C	41
Sec. 3.5 Street Type D	42
Sec. 3.6 Street Type E	43
Sec. 3.7 Street Type F	44
Sec. 3.8 Street Type G	45
Sec. 3.9 Perimeter Streets	46
Sec. 3.10 Public Right of Way Materials	49
Sec. 3.11 Alleys	51

### SUSTAINABILITY GOALS

- » Promote a walkable neighborhood by providing a safe, appealing and comfortable street environment, including continuous sidewalks, on-street parking or a planting strip between the sidewalk & the street as a buffer zone to enhance the sidewalk's walkability and streetscapes amenities, such as benches, street lights, bicycle racks
- » Reduce urban heat island effects by providing street trees and specifying materials with appropriate solar reflective index
- » Specify recycled and reclaimed materials for infrastructure such as streets, sidewalks, curbs, base and sub materials, underground tanks, and piping
- » Specify permeable paving materials where appropriate
- » Implement sustainable street landscapes where grading permits to contribute to the reduction of stormwater runoff

### APPLICABLE LEED-ND POINTS (2009 Standards)

- NPD Pre 1 — Walkable Streets
- NPD Credit 1 — Walkable Streets: Design Speeds for Safe Pedestrian and Bicycle Travel
- NPD Credit 14 — Tree-lined and Shaded Streets
- GIB Credit 8 — Stormwater Management
- GIB Credit 9 — Heat Island Reduction: Non-roof Measures
- GIB Credit 15 — Recycled Content in Infrastructure
- GIB Credit 16 — Solid Waste Management: Recycling Receptacle Integration



## Sec. 3.1 Introduction

The streets in the Lower Hill Site Redevelopment are designated by type. This section provides detailed information about each street type for all elements within the street Right-Of-Way (ROW). These streets shall be enhanced by a pedestrian network as described in Section 2.5 which will provide additional connectivity between the existing neighborhood and the Lower Hill. Streets are organized by ROW width. Wylie Avenue, Street 2 and Street 1 will function as urban connectors. Some streets will be small in scale and have more of a passive feel, while others will be more animated with a mix of uses and outdoor dining, resulting in a more active environment. Standards for sidewalks internal to the site are incorporated into the street type standards. Sidewalks on the exterior perimeters of the site have their own respective type designations based on the width of the sidewalk itself.

Streets play a critical role in managing stormwater and will therefore be designed to help meet the requirement to capture the 95th percentile runoff on site. Despite the steep topography, the four internal streets with the majority of pedestrian traffic are designed to a 5% slope and will be fully accessible. These streets (shown in green in Figure 3.1) are ideal to apply infiltration planters that capture the first 1.2 inches of rainwater. Strategies related to this landscape treatment can be found in Section 2.3.

The pages that follow describe the desired character of each street type. The descriptions of this section are requirements of this Preliminary Land Development Plan that are subject to approval of the Department of Public Works.



FIGURE 3.1 Sustainable and Accessible Streets Diagram

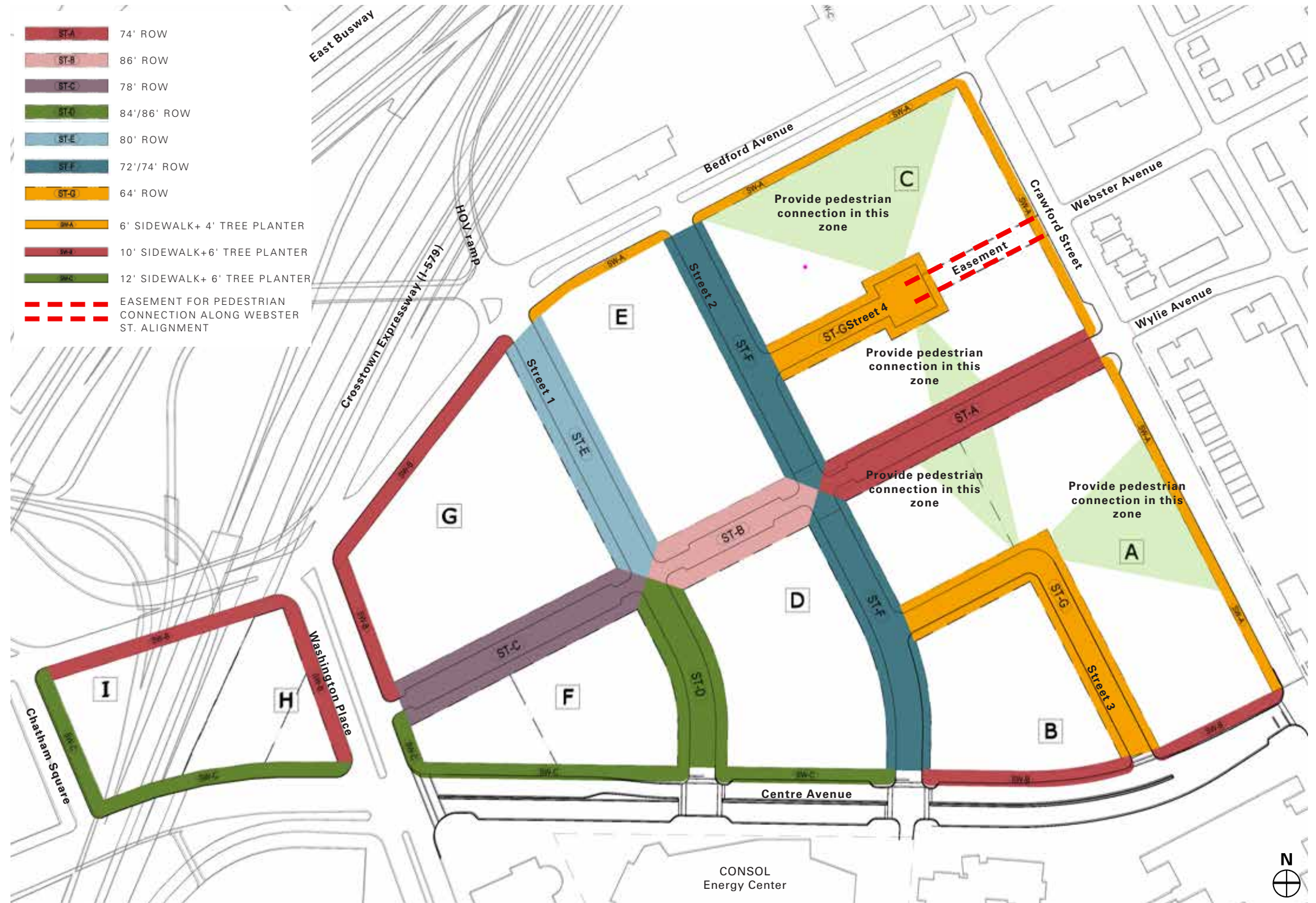

FIGURE 3.2 Streets Type Diagram



## Sec. 3.2 Street Type A

Street Type A is designed with a 10-foot sidewalk and a 6-foot tree planting area, which provide for an additional buffer along heavily travelled streets. A mix of residential and commercial uses are best suited along these streets. Large street trees will shade sidewalks and shall be located as required by the Zoning Ordinance. Parallel parking will serve as short term and visitor parking.

Refer to Section [6.5] for material types within the ROW.

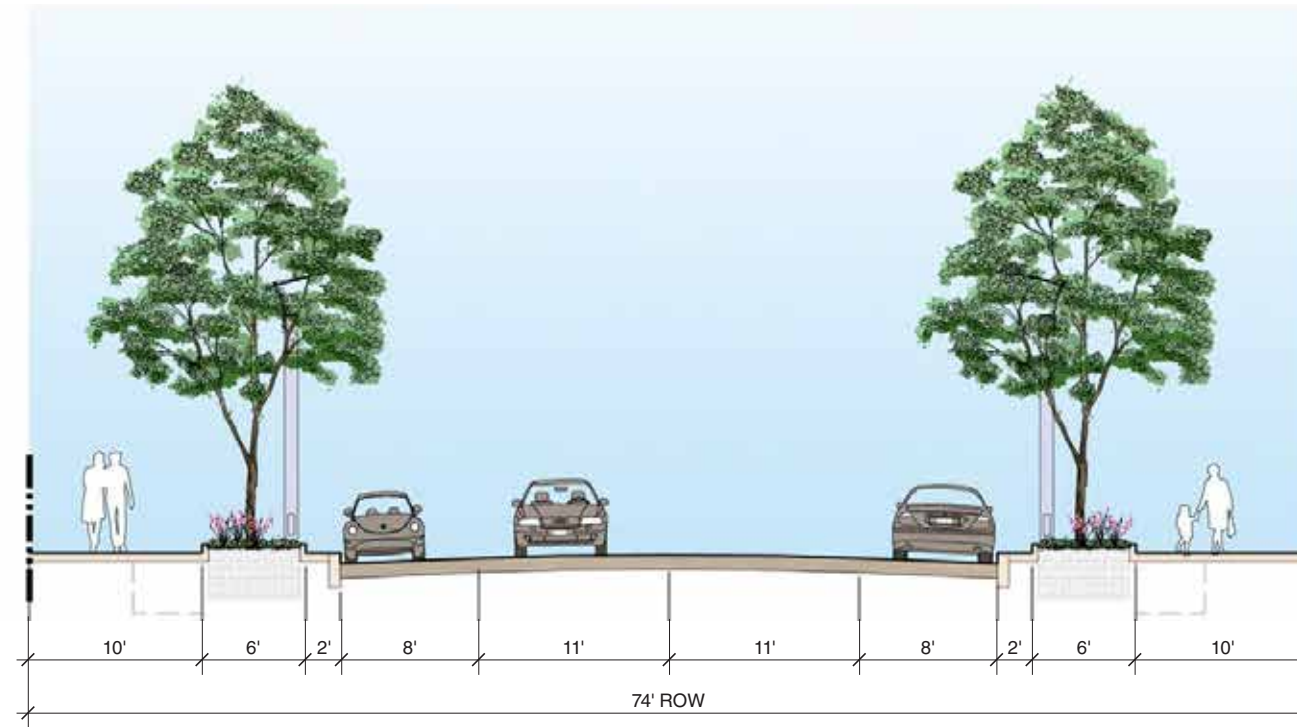

FIGURE 3.3 Street Type A Section

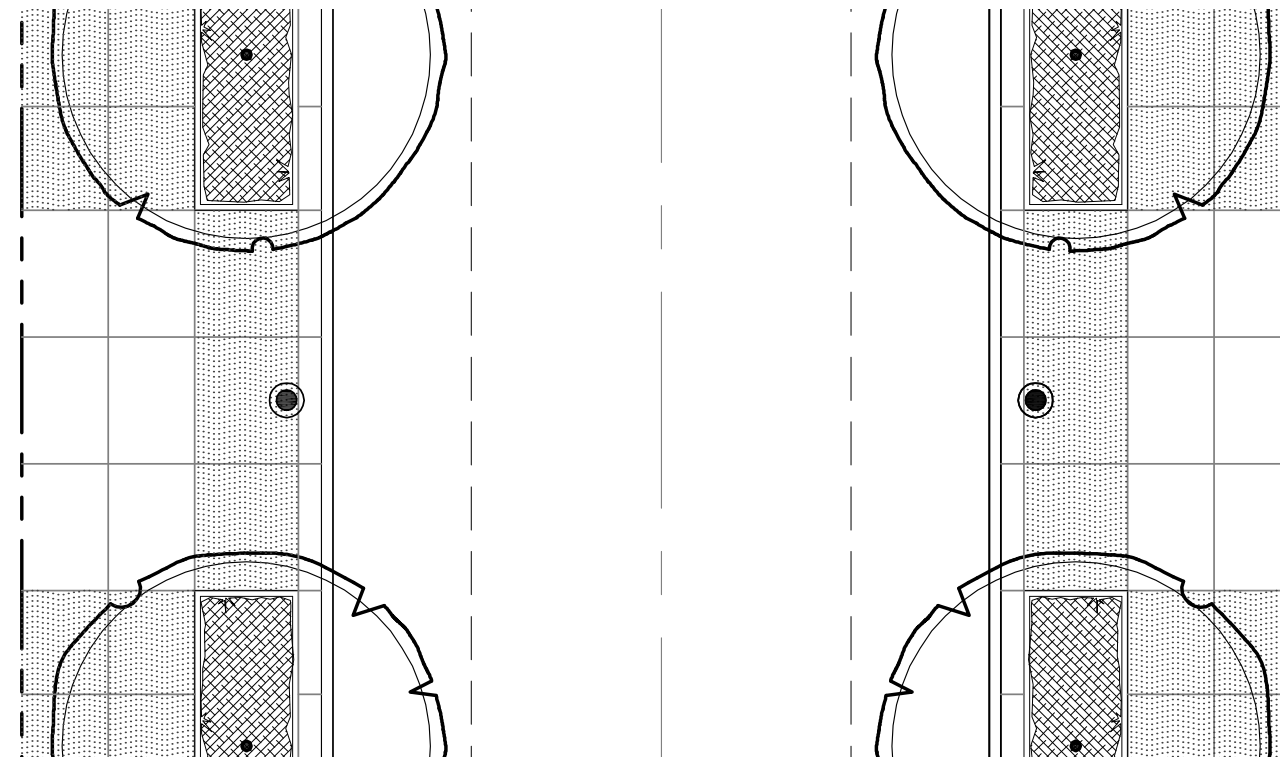

FIGURE 3.5 Street Type A Plan



FIGURE 3.4 Street Type A Location Diagram

TABLE 3.1 Street Type A Properties

Dimensions and Zones	
Right of Way Width	74 ft
Cartway Width	38 ft
Travel Lanes	(2) 11 ft
Parking Lanes	(2) 8 ft
Sidewalk Width	10 ft
Planter Width	6 ft
Intersection and Safety	
Crosswalks	yes
Curb Type	raised
Curb Radii	20 ft max.
Curb Bump-outs	yes
Infrastructure	
Drainage Type	conventional/ sustainable
Alternative Modes	
Bicycle	in-lane
Transit Service	yes



## Sec. 3.3 Street Type B

Street Type B is one of several street types that are designed to serve a mix of uses. This will be more of an urban street type and will feature street trees at regular intervals as required by the Zoning Ordinance. Parallel parking will serve as short-term and visitor parking.

Refer to Section [6.5] for material types within the ROW.



FIGURE 3.6 Street Type B Section

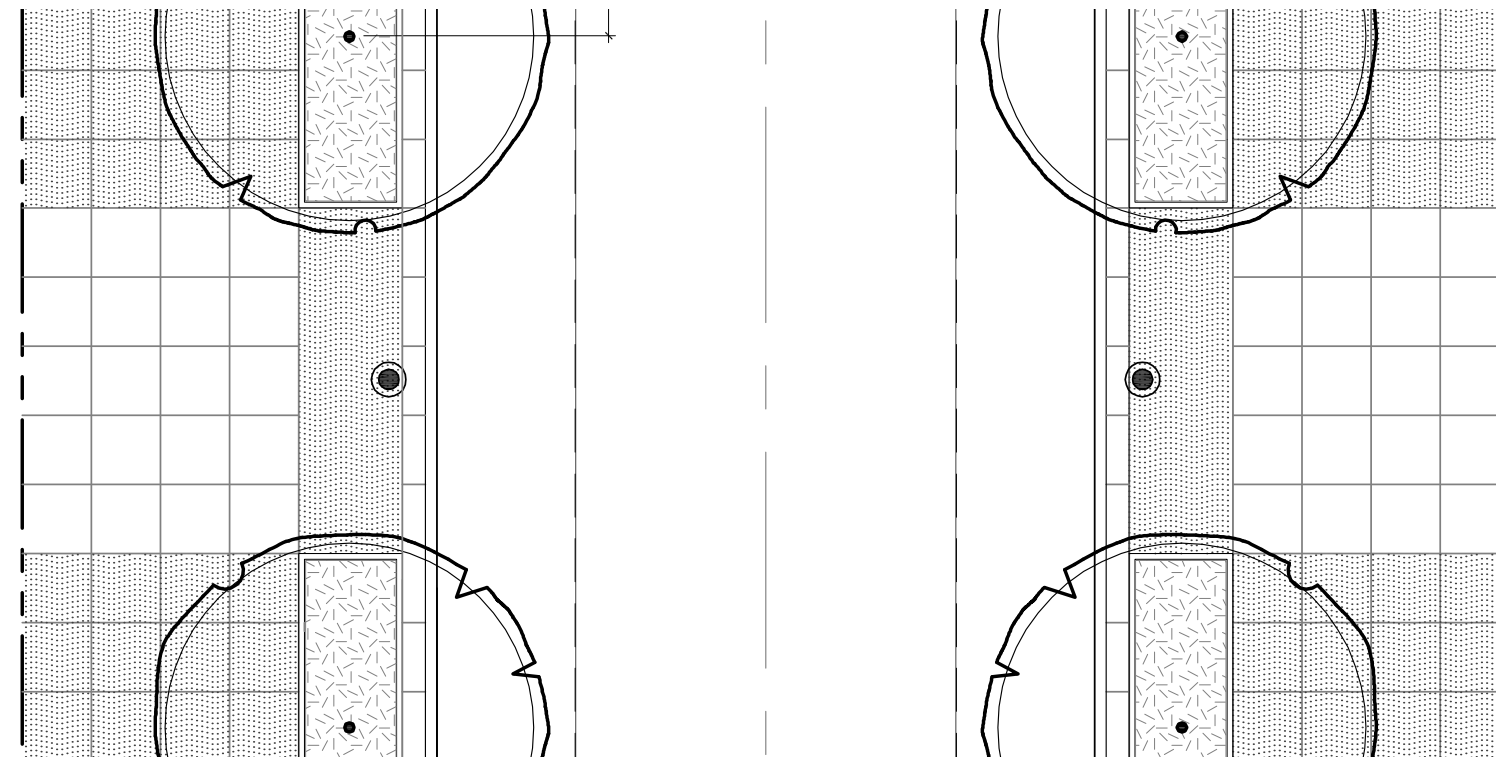

FIGURE 3.8 Street Type B Plan



FIGURE 3.7 Street Type B Location Diagram

TABLE 3.2 Street Type B Properties	
<b>Dimensions and Zones</b>	
Right of Way Width	86 ft
Cartway Width	38 ft
Travel Lanes	(2) 11 ft
Parking Lanes	(2) 8 ft
Sidewalk Width	16 ft
Planter Width	6 ft
<b>Intersection and Safety</b>	
Crosswalks	yes
Curb Type	raised
Curb Radii	20 ft. max.
Curb Bump-outs	yes
<b>Infrastructure</b>	
Drainage Type	sustainable
<b>Alternative Modes</b>	
Bicycle	in-lane
Transit Service	yes



## Sec. 3.4 Street Type C

Street Type C is also designed to serve a mix of uses. This typology is intended for the primary shopping streets. Sidewalks are sufficient to accommodate commercial activity while still providing an appealing residential environment.

This street type will also feature street trees to ensure shading a comfortable pedestrian environment as required by the Zoning Ordinance. Parallel parking will serve as short term and visitor parking.

Refer to Section [6.5] for material types within the ROW.

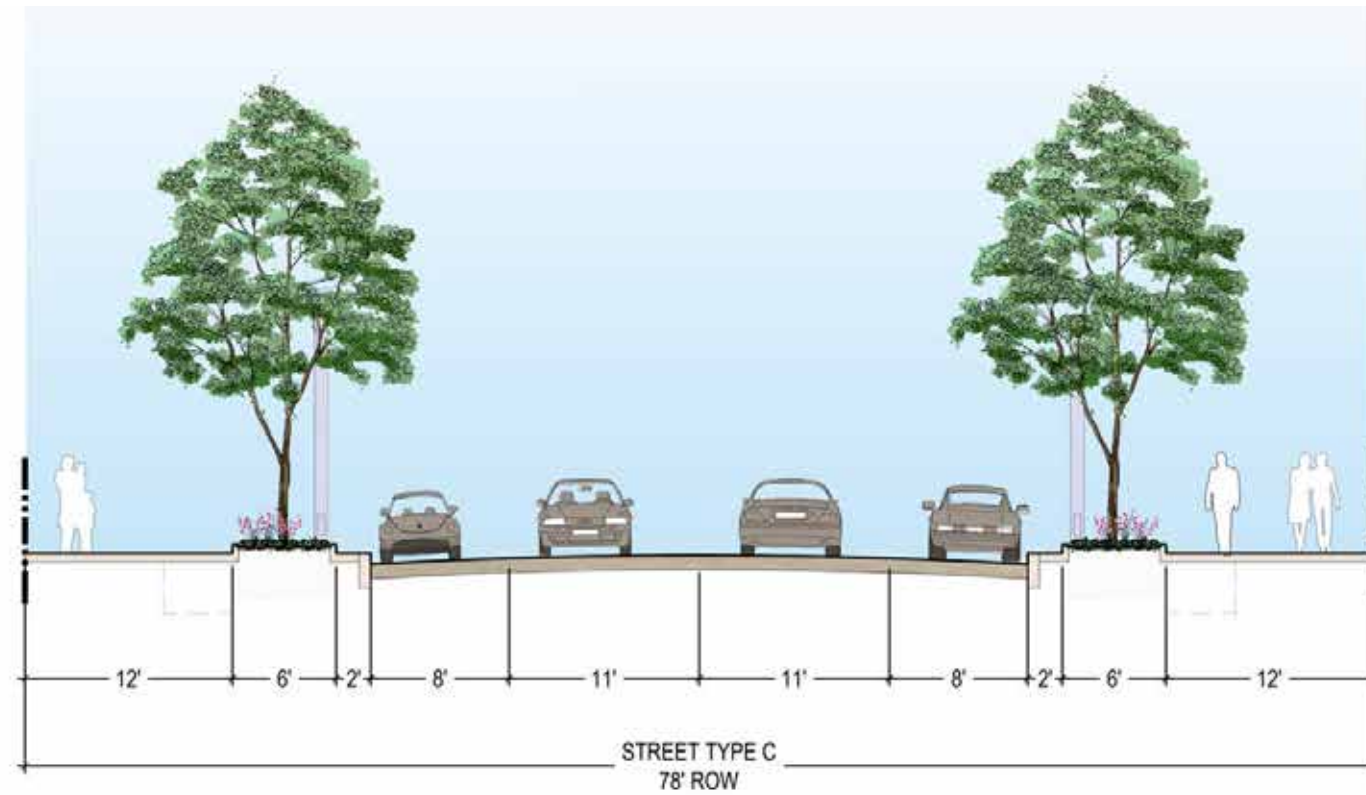

FIGURE 3.9 Street Type C Section



FIGURE 3.10 Street Type C Location Diagram

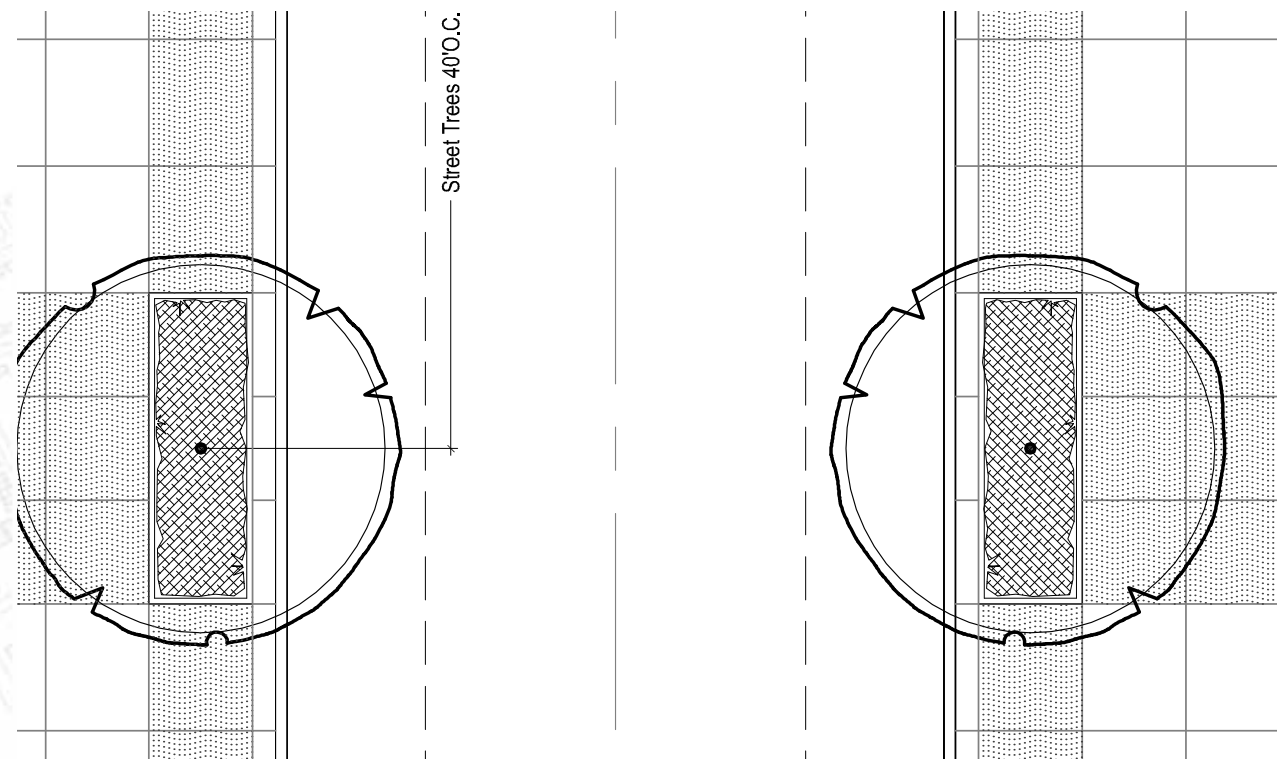

FIGURE 3.11 Street Type C Plan

TABLE 3.3 Street Type C Properties

Dimensions and Zones	
Right of Way Width	78 ft
Cartway Width	38 ft
Travel Lanes	(2) 11 ft
Parking Lanes	(2) 8 ft
Sidewalk Width	12 ft
Planter Width	6 ft
Intersection and Safety	
Crosswalks	yes
Curb Type	raised
Curb Radii	20 ft. max.
Curb Bump-outs	yes
Infrastructure	
Drainage Type	conventional/ sustainable
Alternative Modes	
Bicycle	in-lane
Transit Service	no



## Sec. 3.5 Street Type D

Street Type D is designed as a flexible street type that can function as both a conventional street, and public space for events. This street includes a parking /travel lane, and an alternate condition that implements flush curbs and bollards at the curb line. This design creates a more pedestrian-friendly environment within the street ROW so that during festivals or events in the Urban Open Space the street can be closed and activity can spill out into the street unimpeded. Street trees shall be located as required by the Zoning Ordinance.

Refer to Section 6.5 for material types within the ROW.

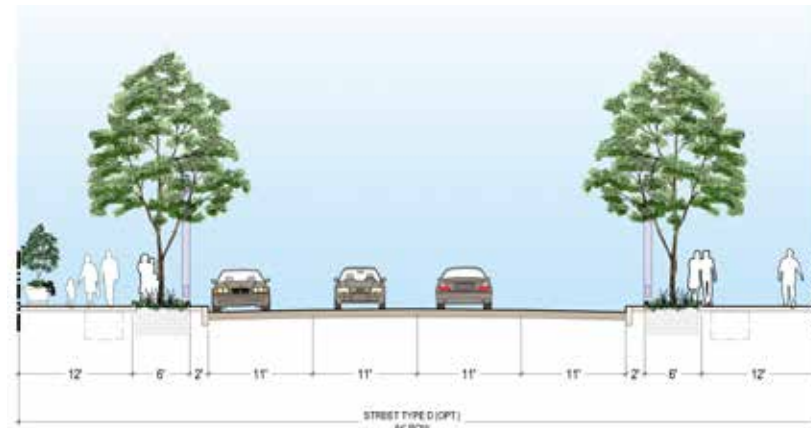

FIGURE 3.12 Street Type D Section alternate design with standard curb detail

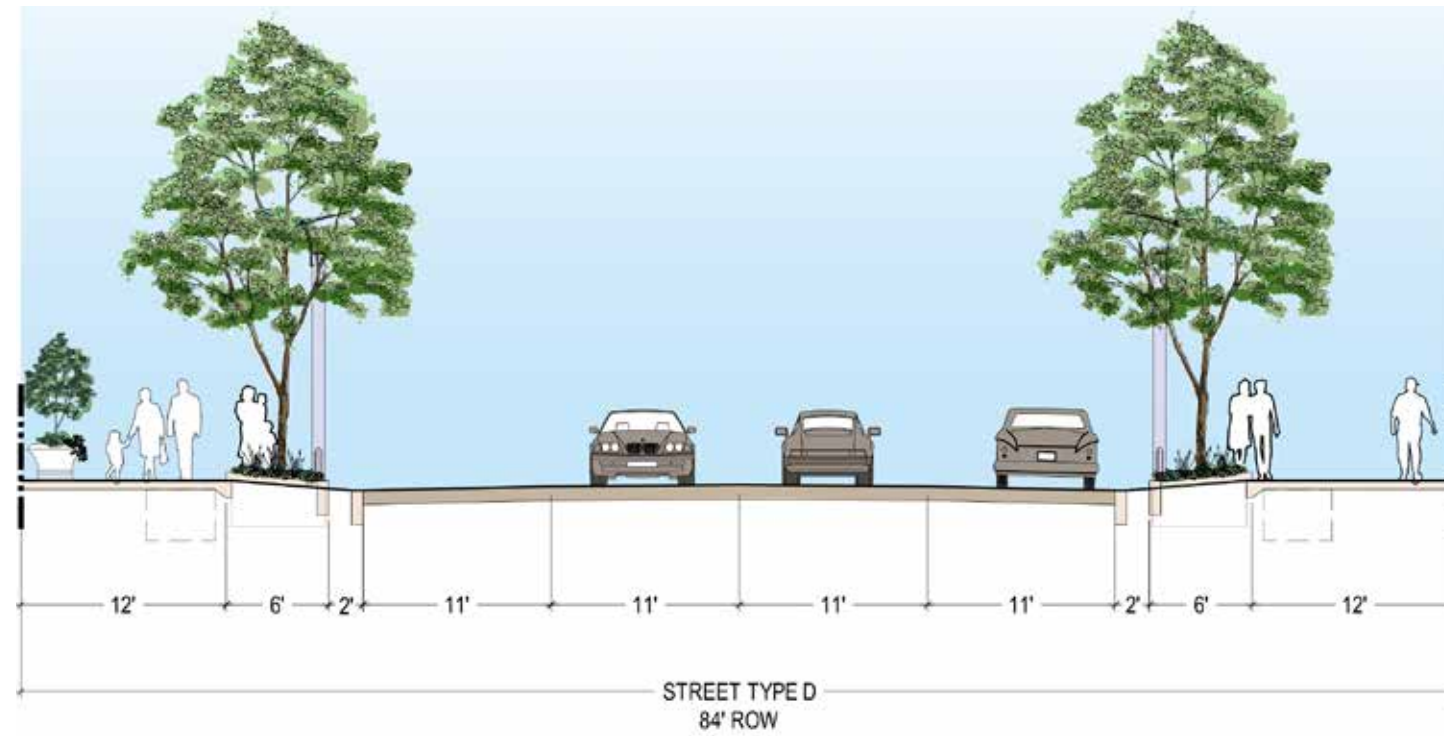

FIGURE 3.14 Street Type D Section

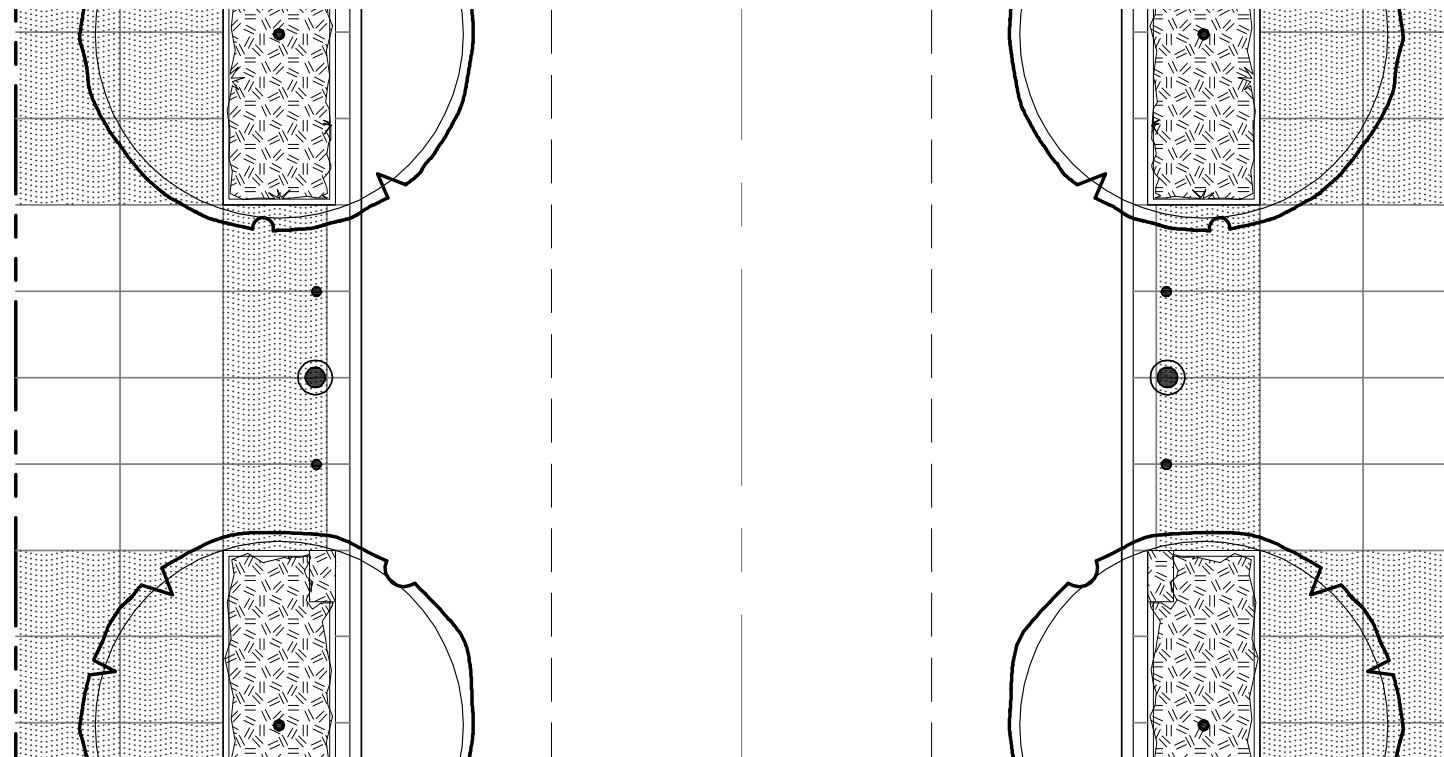

FIGURE 3.15 Street Type D Plan



FIGURE 3.13 Street Type D Location Diagram

TABLE 3.4 Street Type D Properties	
<b>Dimensions and Zones</b>	
Right of Way Width	84 ft
Cartway Width	44 ft
Travel Lanes	(2) 11 ft
Parking/Travel Lanes	(2) 11 ft
Sidewalk Width	12 ft
Planter Width	8 ft
<b>Intersection and Safety</b>	
Crosswalks	yes
Curb Type	flush/raised
Curb Radii	20 ft. max.
Curb Bump-outs	no
<b>Infrastructure</b>	
Drainage Type	sustainable
<b>Alternative Modes</b>	
Bicycle	in-lane
Transit Service	yes



## Sec. 3.6 Street Type E

Street Type E is designed to have one dedicated travel lane in each direction with a second lane that can become flexible between parallel parking during normal use and travel lanes during highly trafficked events. This extra width in the cartway will also make this street type a preferred route for buses. Street trees shall be located as required by the Zoning Ordinance.

Refer to Section 6.5 for material types within the ROW.

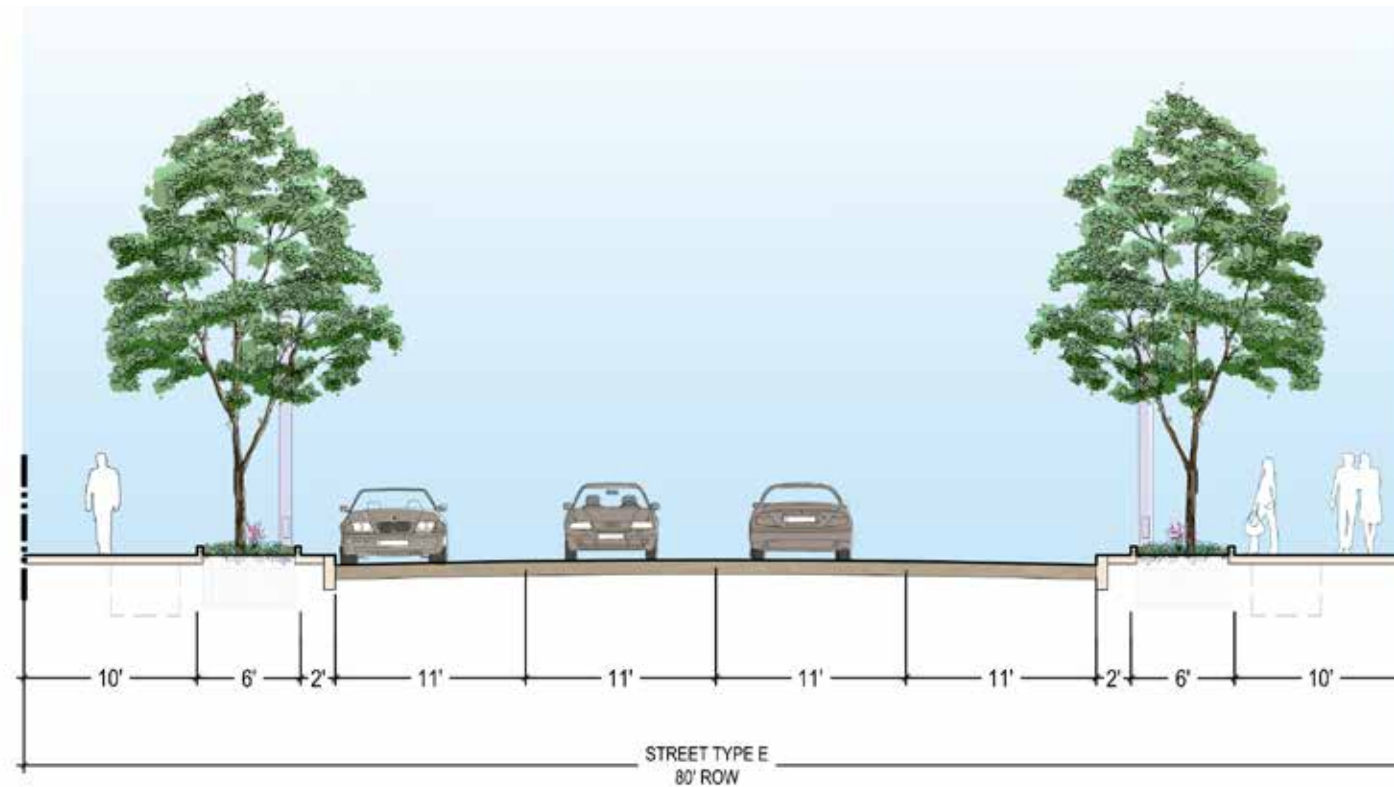

FIGURE 3.16 Street Type E Section

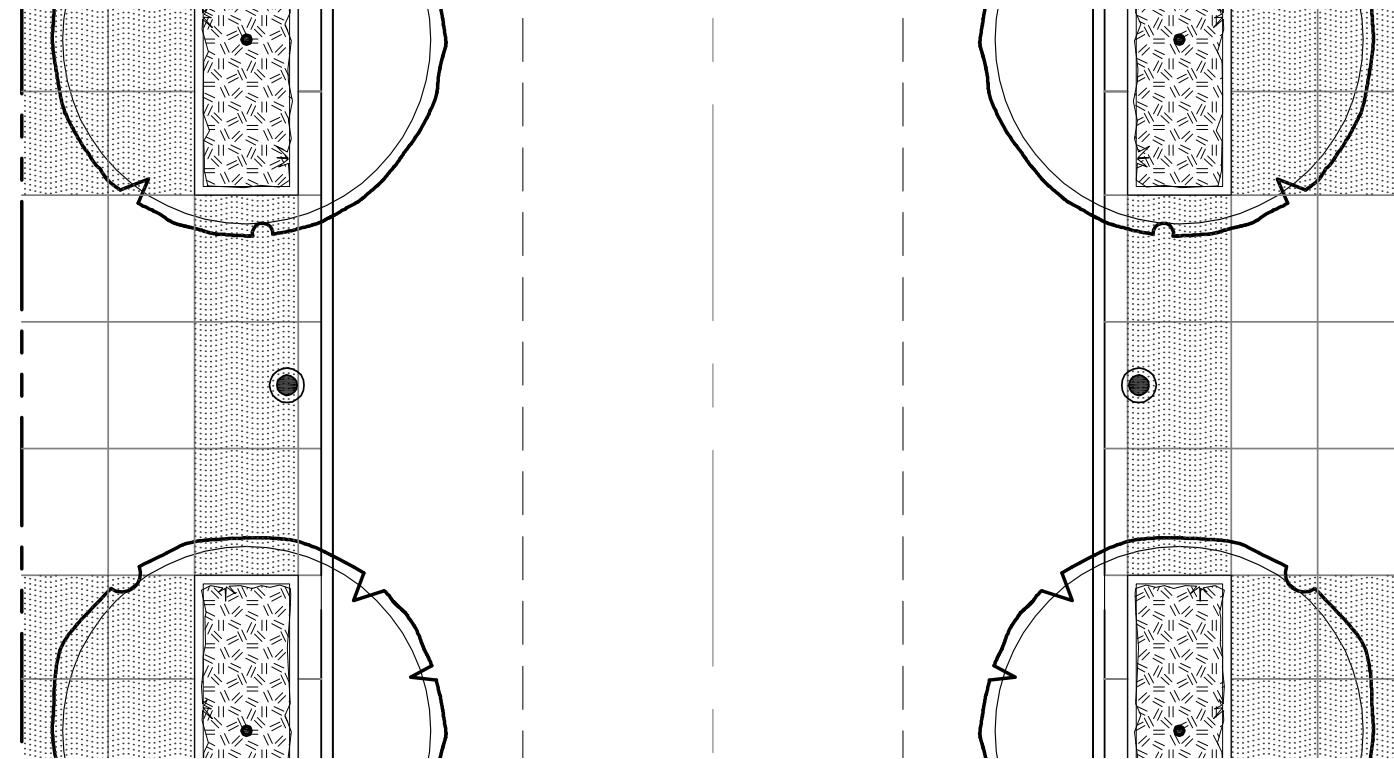

FIGURE 3.18 Street Type E Plan



FIGURE 3.17 Street Type E Location Diagram

TABLE 3.5 Street Type E Properties	
<b>Dimensions and Zones</b>	
Right of Way Width	80 ft
Cartway Width	44 ft
Travel Lanes	(2) 11 ft
Parking/Travel Lanes	(2) 11 ft
Sidewalk Width	10 ft
Planter Width	6 ft
<b>Intersection and Safety</b>	
Crosswalks	yes
Curb Type	raised
Curb Radii	20 ft. max.
Curb Bump-outs	no
<b>Infrastructure</b>	
Drainage Type	sustainable
<b>Alternative Modes</b>	
Bicycle	in-lane
Transit Service	yes



## Sec. 3.7 Street Type F

Street Type F is similar to Street Type E but is designed with narrower sidewalks which are appropriate for anticipated residential uses on this block. All sidewalk widths are 6 feet except for the western sidewalk along Block D where the width is 8 feet. This street type includes one dedicated travel lane in each direction with a second lane that can 'flex' between parallel parking during normal use and travel lanes during peak traffic hours. Street trees shall be located as required by the Zoning Ordinance.

Refer to Section 6.5 for material types within the ROW.

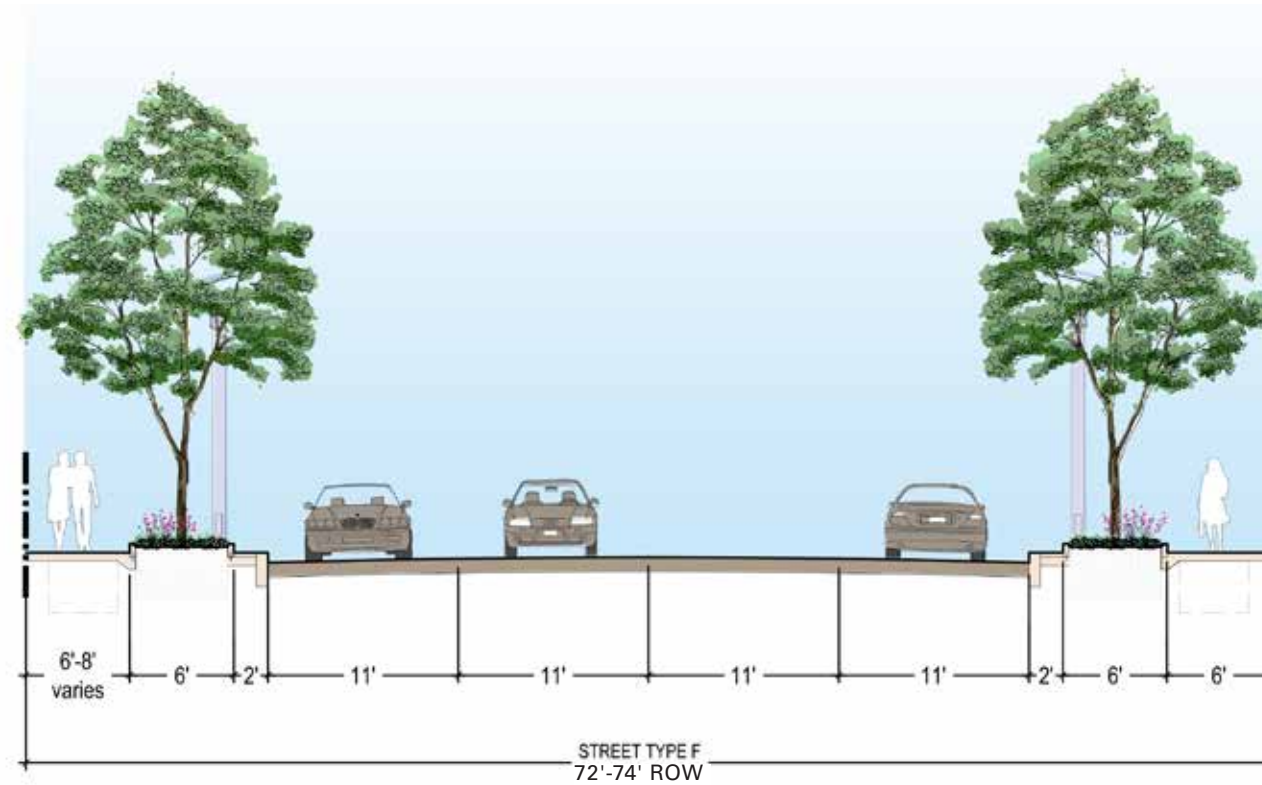

FIGURE 3.19 Street Type F Section



FIGURE 3.20 Street Type F Location Diagram

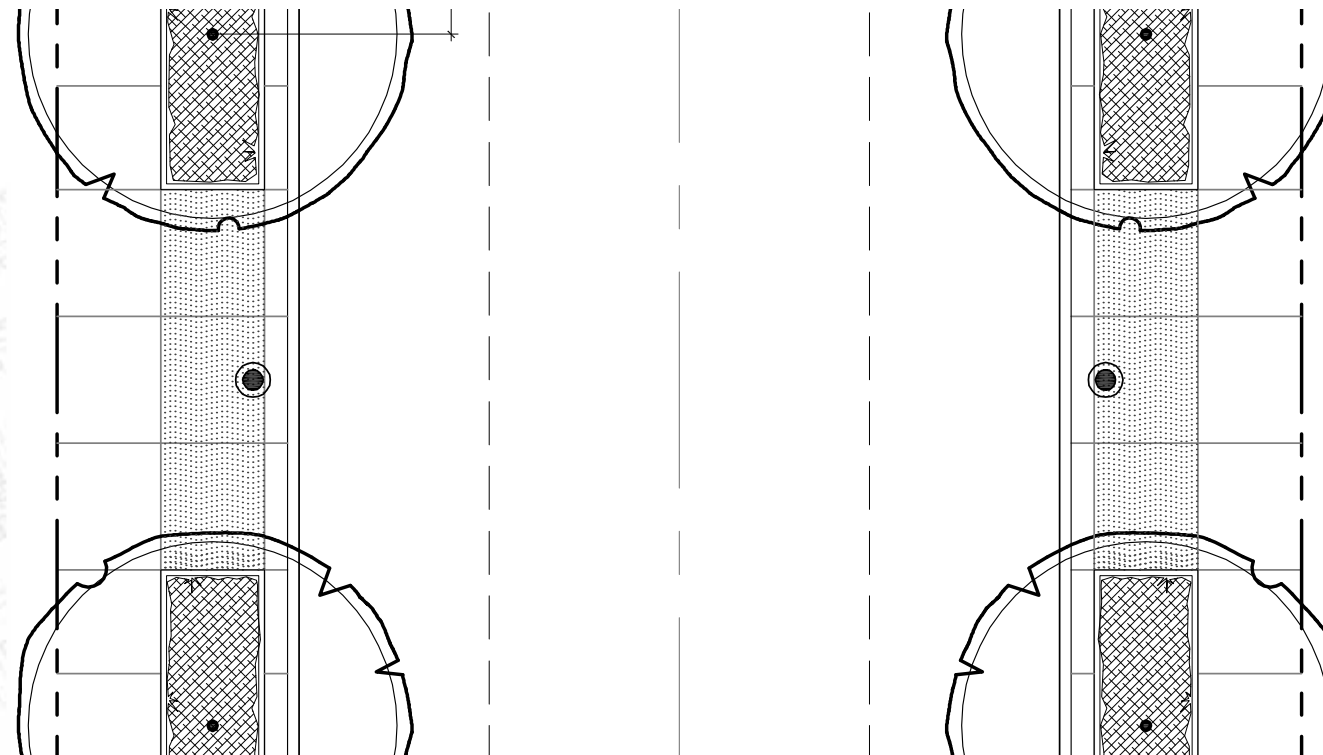

FIGURE 3.21 Street Type F Plan

TABLE 3.6 Street Type F Properties

Dimensions and Zones	
Right of Way Width	72ft/74 ft
Cartway Width	44 ft
Travel Lanes	(2) 11 ft
Parking/Travel Lanes	(2) 11 ft
Sidewalk Width	6 - 8 ft (varies)
Planter Width	6 ft
Intersection and Safety	
Crosswalks	yes
Curb Type	raised
Curb Radii	20 ft. max.
Curb Bump-outs	yes
Infrastructure	
Drainage Type	conventional, sustainable
Alternative Modes	
Bicycle	in-lane
Transit Service	(alternate transit route Wylie to Centre)



## Sec. 3.8 Street Type G

Street Type G is the smallest street type and is intended to be residential in character. It is a secondary connection, and will provide access for residents on Blocks A and B. It will function like a traditional Pittsburgh street with parallel parking on both sides for short term and visitor parking. Large street trees will shade sidewalks and buildings will be setback with a front yard or planting area.

Refer to Section 6.5 for material types within the ROW.

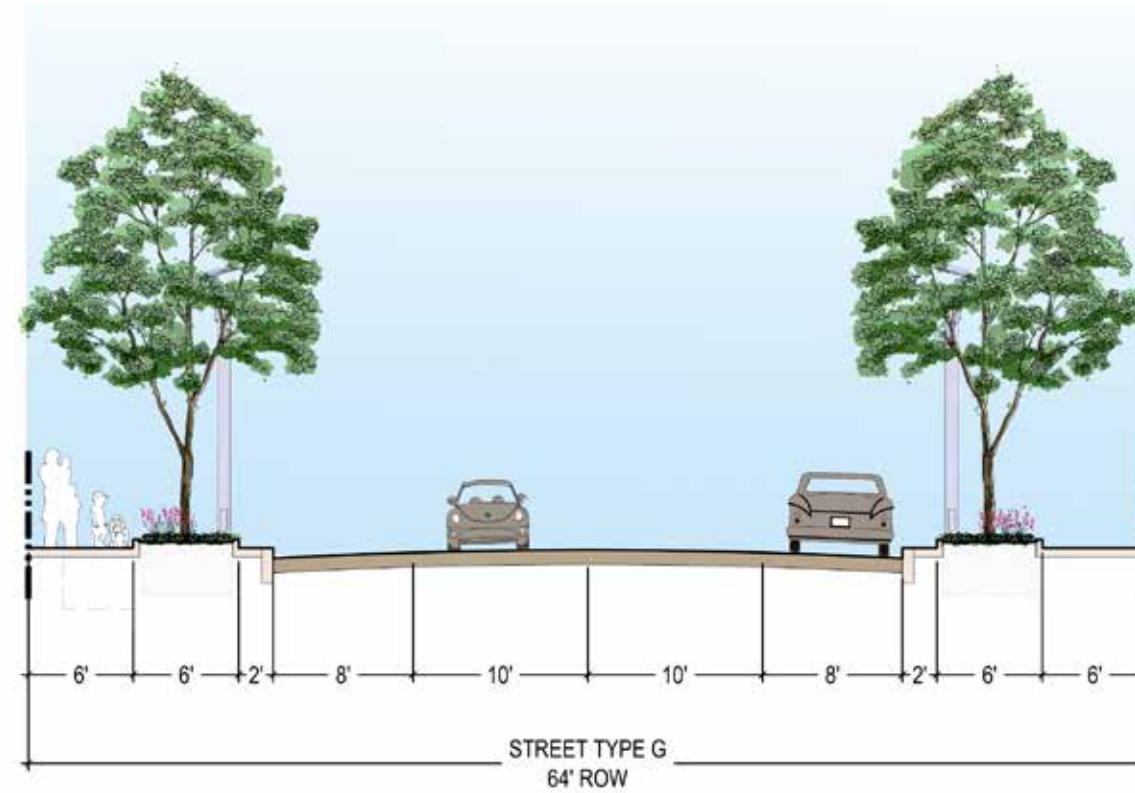

FIGURE 3.22 Street Type G Section

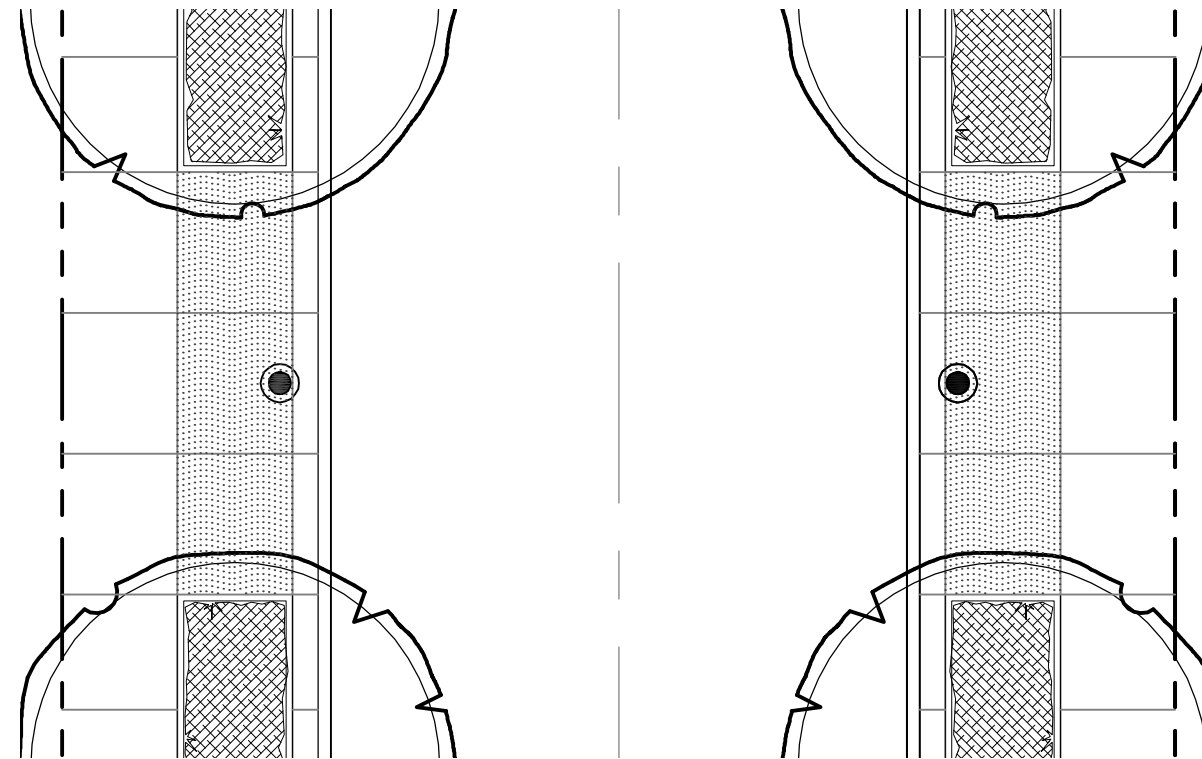

FIGURE 3.24 Street Type G Plan



TABLE 3.7 Street Type G Properties

Dimensions and Zones	
Right of Way Width	64 ft
Cartway Width	36 ft
Travel Lanes	(2) 10 ft
Parking Lanes	(2) 8 ft
Sidewalk Width	6 ft
Planter Width	6 ft
Intersection and Safety	
Crosswalks	yes
Curb Type	raised
Curb Radii	20 ft. max.
Curb Bump-outs	no
Infrastructure	
Drainage Type	sustainable/ conventional
Alternative Modes	
Bicycle	in-lane
Transit Service	no



### Sec. 3.9 Perimeter Streets

This section is intended to provide additional regulations for improvements to the existing perimeter streets as they have an important impact on the successful development of the Lower Hill Redevelopment Site. In the depictions that follow, certain improvements are labeled “required” which signifies that such improvements are mandatory. There are also a series of recommended improvements which are described in more detail in Section 9: Off-Site Improvements. The pages that follow describe required improvements to Bedford Avenue; Crawford Avenue; Washington Place, and Centre Avenue.



© 2014 URBAN DESIGN ASSOCIATES



3.9.1 Bedford Avenue, Crawford Ave, and Washington Place

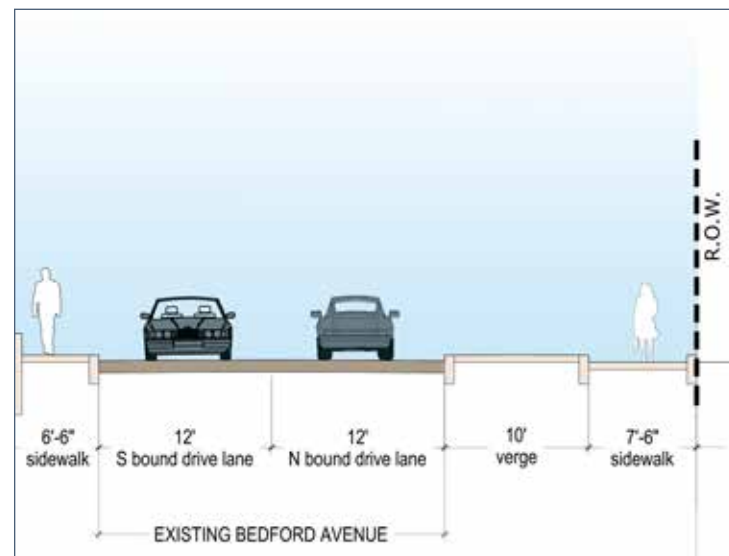
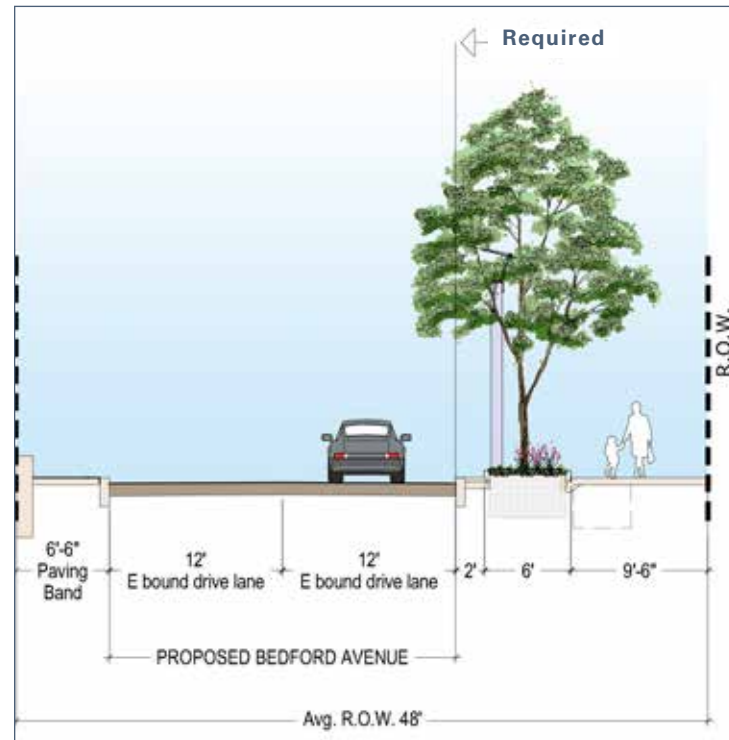

FIGURE 3.30 Bedford Avenue Section A-A'

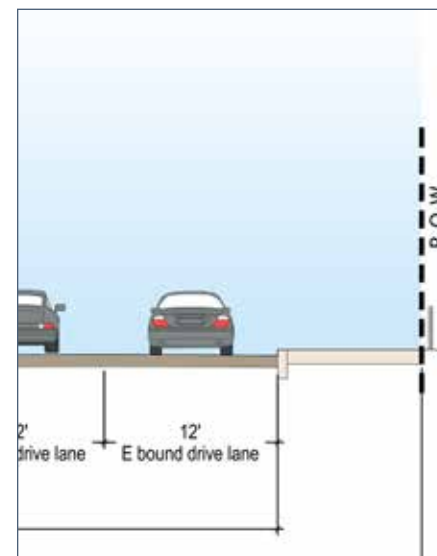
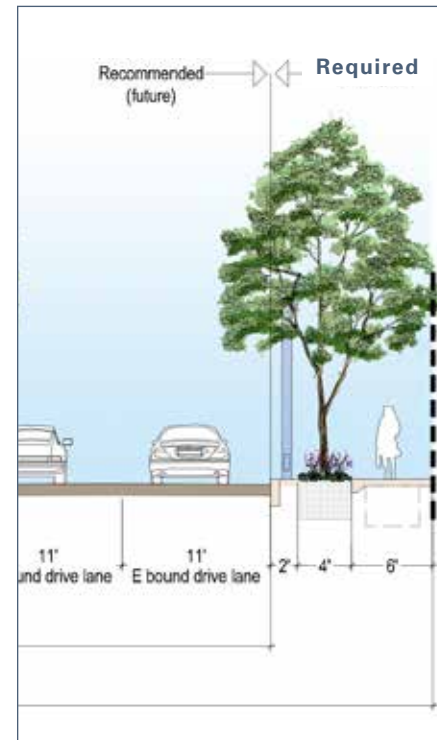

FIGURE 3.31 Bedford Avenue Section B-B'

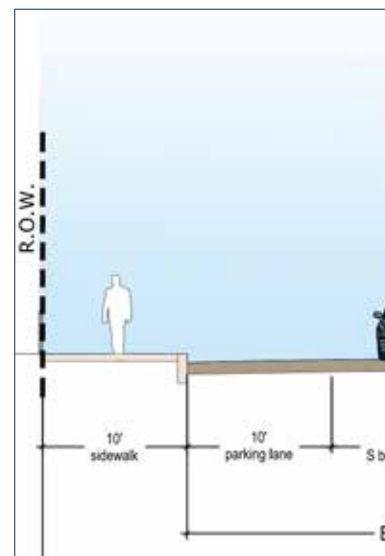
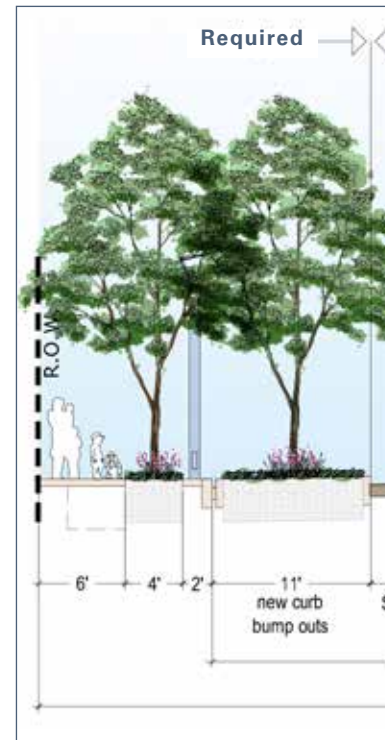

FIGURE 3.32 Crawford Street Section C-C'

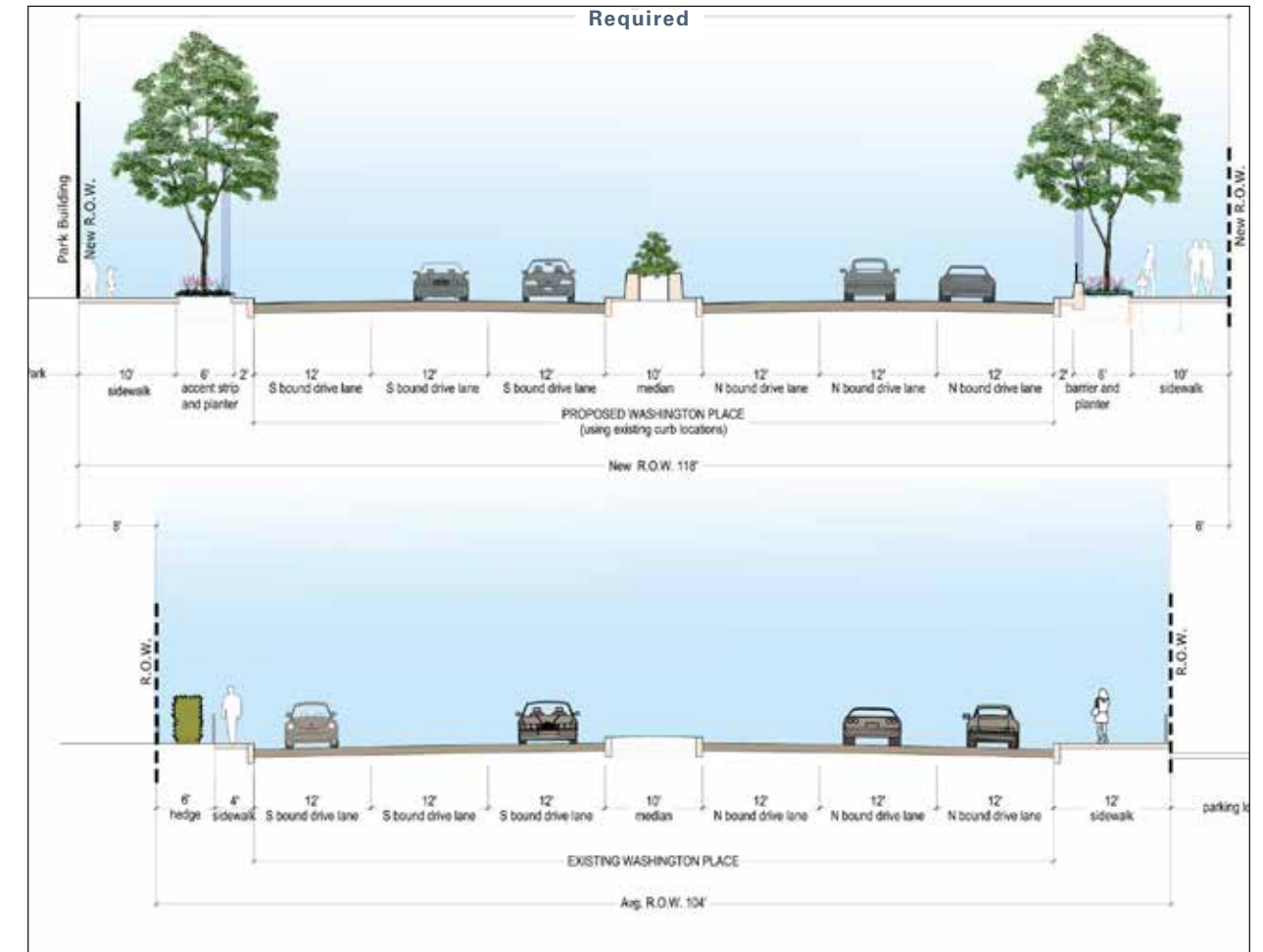

FIGURE 3.33 Washington Place Section G-G'



3.9.2 Centre Avenue

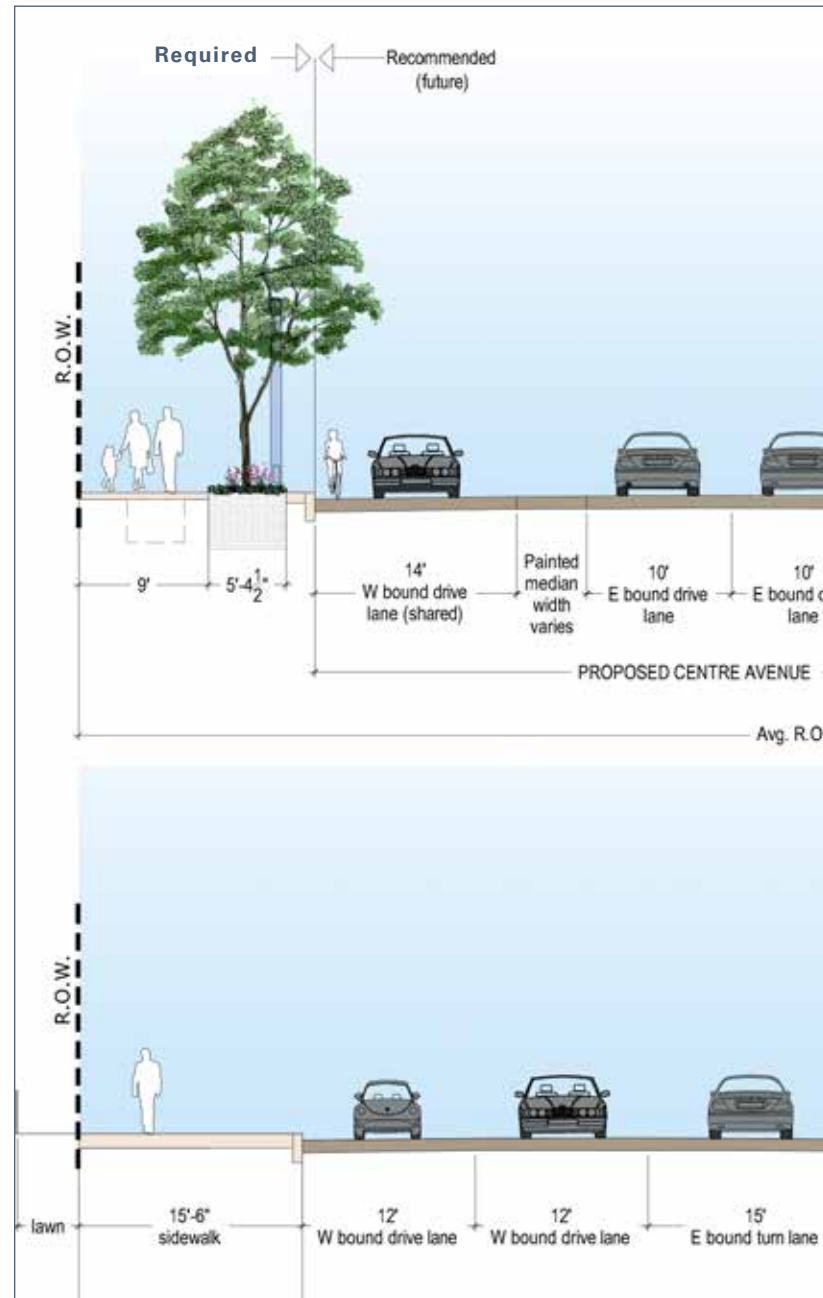

FIGURE 3.34 Centre Avenue Section D-D' (at intersection of Centre and Crawford)

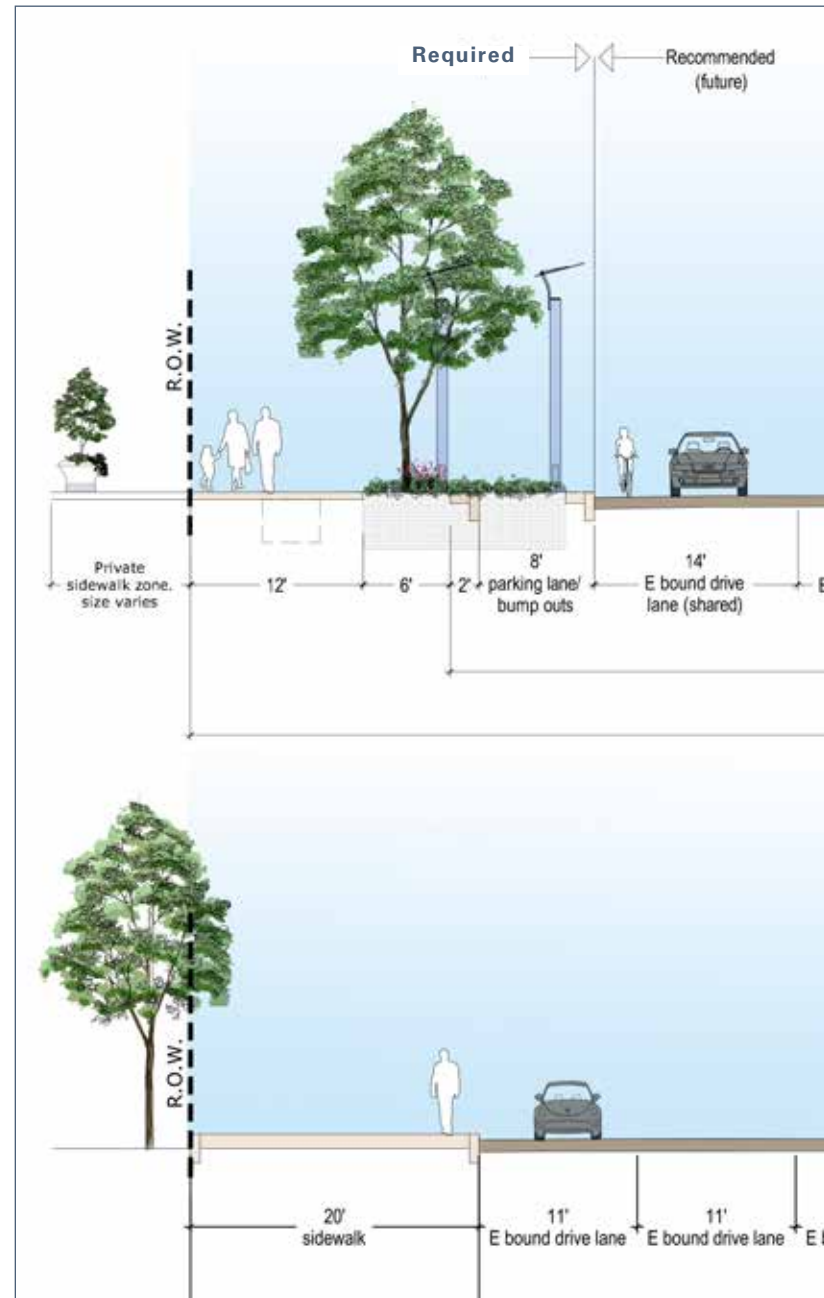

FIGURE 3.35 Centre Avenue Section E-E'

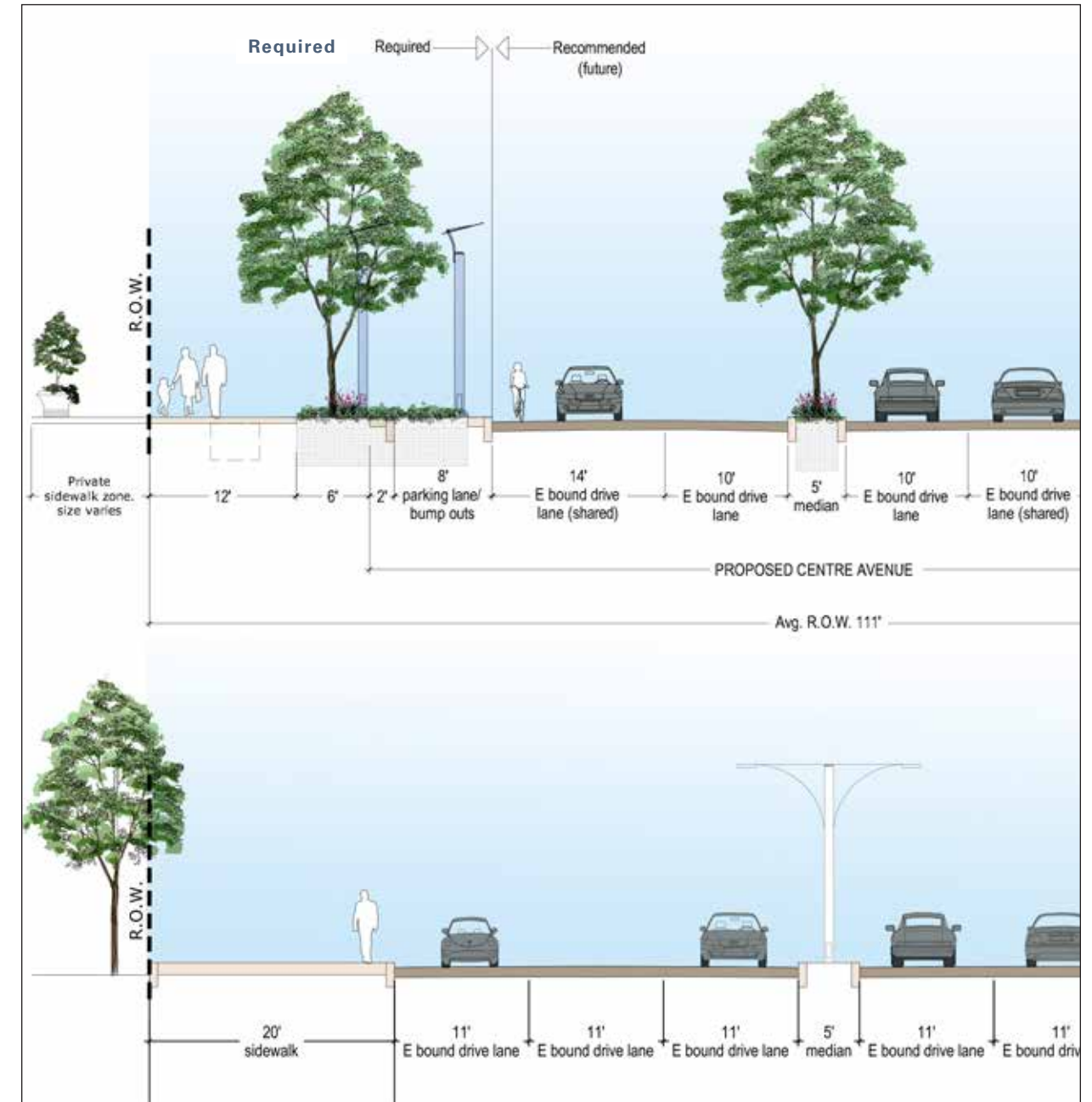

FIGURE 3.36 Centre Avenue Section F-F' (approaching Washington Place)



## Sec. 3.10 Public Right of Way Materials

This section provides regulations that (i) confirm the applicable City standards for rights of way within the Lower Hill Redevelopment Site and (ii) provide supplemental standards that improve upon existing City standards to help achieve LEED ND and sustainability goals of the this PLDP. Implementation of these regulations is subject to approval of the Department of Public Works.

### A. Paving Materials

- » Street Paving: concrete finished street, depth and finish to meet City of Pittsburgh Standards.
- » Curbs: 8 inches wide and maximum 6 inches exposed face deep concrete curbs meeting City of Pittsburgh Standards.
- » Curb Apron: Minimum 6-inch thick broom finish concrete
- » Main Sidewalk Area: For streets with 10 feet or greater depth of sidewalk, minimum 4-inch thick pattern of alternate bands of paving shall be installed using broom finish or trowel finish concrete with exposed aggregate concrete paving alternating with rhythm of tree planters. Refer to diagram in Section 3. For streets with less than 10-foot depth of sidewalk, minimum 4-inch thick of continuous broom finish or trowel finish concrete shall be installed with a continuous parallel exposed aggregate concrete paving at the tree planter verge.
- » Tree Planter Verge: Minimum 4-inch thick exposed aggregate concrete paving connecting all tree planters in verge. Refer to diagram in Section 3. For street with stormwater tree planter basins, permeable pavers can be used connecting the basins. Refer to diagram in Section 3.
- » Tree Planter Protection: 4-inch concrete curbs shall define the edges of each tree planter to protect plantings and reduce salt damage. As an alternate, decorative perimeter fencing can be used to control traffic.
- » Crosswalks: At Wylie Avenue intersections with Street 1 and Street 2, crosswalks shall be delineated with either brick or special paving (per DPW standards). At all other intersections, painted lines shall be required. Handicapped ramps with ADA warning pavers shall meet City of Pittsburgh Standards.



FIGURE 3.37 Example of brick crosswalk and ADA compliant detectable warning pavers.



FIGURE 3.38 Example of concrete planter curb, planting bed, and broom finish concrete sidewalk.



FIGURE 3.39 Example of exposed aggregate paving, broom finish concrete paving, and concrete planter curb.

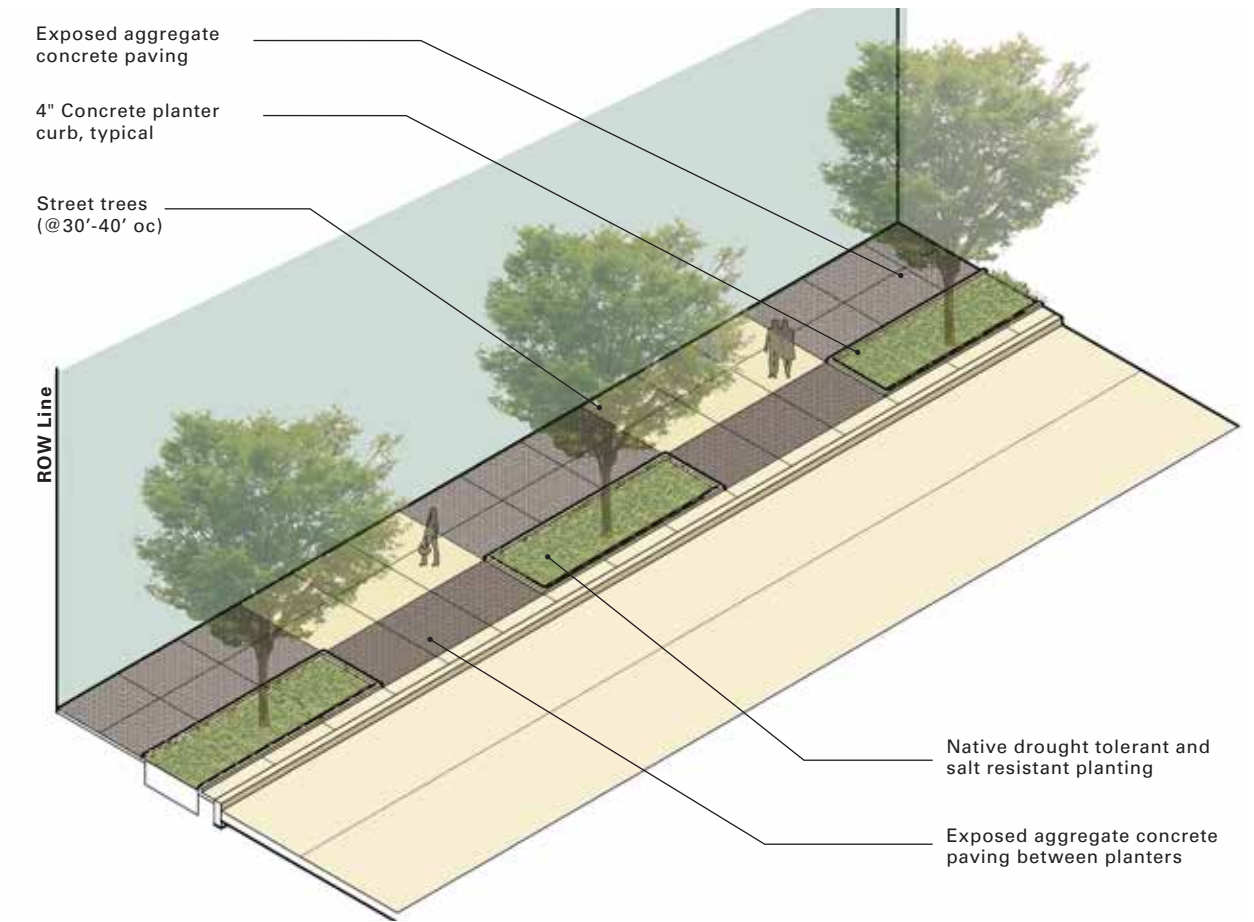

FIGURE 3.40 Axonometric drawing showing street paving configurations. Exposed aggregate paving aligns with the tree planters and extends to the ROW line, alternating with broom finish concrete between planters along the public sidewalk. Exposed aggregate paving is used in the band between planters, and a broom finish concrete accent strip is adjacent to the street curb.

*Note: For Sustainable Streets, refer to Section 3.2 for drawing section showing infiltration planters*



FIGURE 3.41 Example of tree planter protection fence in addition to planter curb for high traffic areas.



**B. Plant Materials**

- » Street Trees: Trees to be specimen grade, street tree quality with a minimum 3- to 3½-inch caliper, at 30 to 40 feet oc, and planted in specified top soil mixture. Ground plantings vary depending on location. Refer to Section 6.4 Planting Palette for various applications.

**C. Barrier Railings**

- » If conditions warrant, barrier railings should be used to control pedestrian flow and for safety where abrupt grade changes occur. All railings are to meet the current City of Pittsburgh’s Building Code and be a minimum of 42 inches in height. Materials shall be durable metals, preferably stainless or painted steel or aluminum. These Barrier Railings shall be considered as an opportunity for integrating art in the public realm.
- » At Washington Place, a barrier railing shall be required between Centre Avenue and Bedford Avenue to ensure pedestrian crossings at the desired locations. Refer to Figure 3.41.

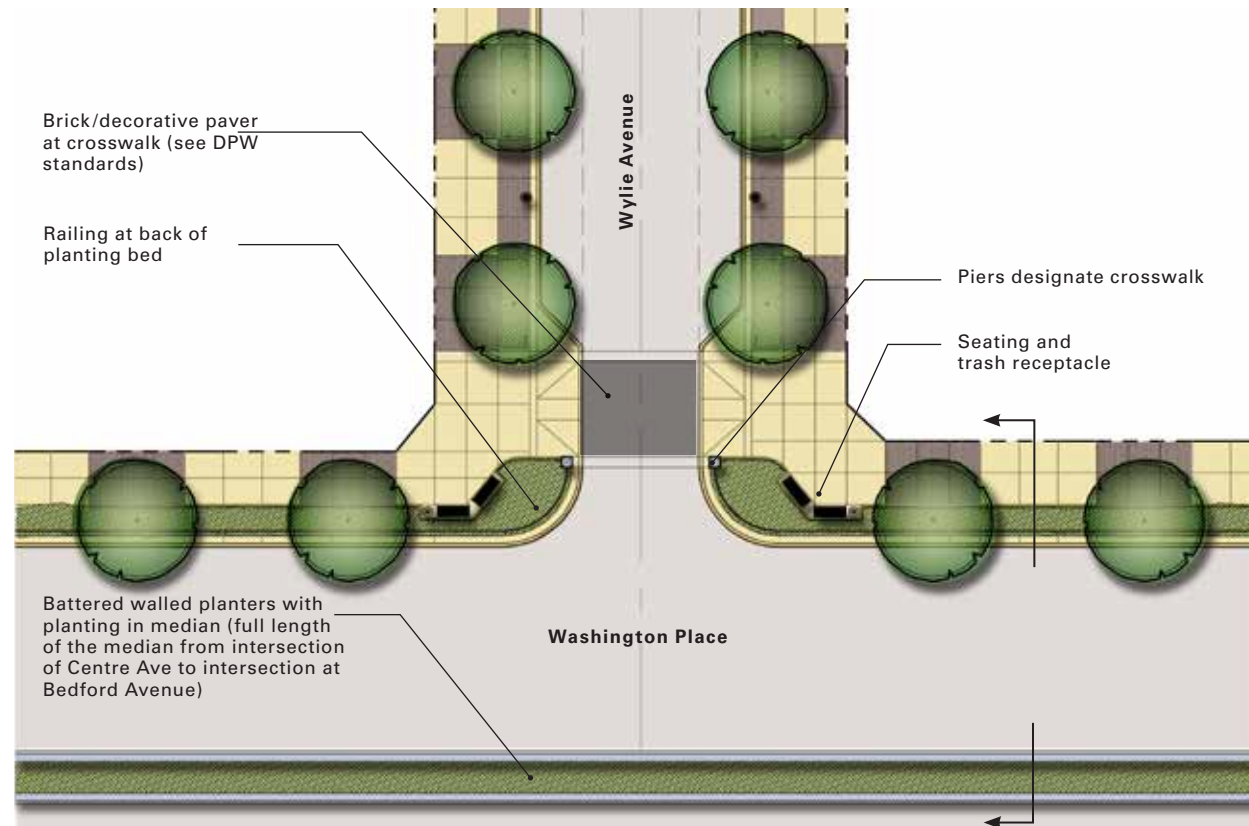

FIGURE 3.42 Enlarged section and plan of barrier control at intersection of Wylie Avenue and Washington Place. Battered wall planters, similar to the planters at Grant Street will be used in the median along Washington Place. At the intersection, a railing, planting bed, and street trees will help deter cross block pedestrian traffic.



## Sec. 3.11 Alleys

Alleys may be driveways or service lane that occurs on any development block. Beyond their vehicular use, Alleys should also be key contributors to the stormwater strategy for each block and provide important pedestrian connections through blocks where possible. Alleys are intended to be a means to traverse steep blocks, and in some cases, may also serve interior block retail and restaurant functions.

The minimum width for an Alley is 30 feet, and maximum is 40 feet. Building setbacks for Alleys are zero to six feet.

Location of alleys may be anywhere within a development block but is restricted by curb cut allowances and locations as indicated in the street and connections regulating plan. Alleys may be employed to achieve the pedestrian connectivity described in Section 2.5, in which case they must be designed to support pedestrians and may be subject to an easement for public use, with specific usage regulations as needed.

Due to steep slopes, it may not be possible for Alleys to be constructed as a continuous driveway or sloped pedestrian connection. In these cases, every effort should be made to ensure continuity in pedestrian route through stairways, switchback ramps, elevators or other solutions. The image below describes one way that topography can be handled.



FIGURE 3.43 Artist depiction of one method to handle the pedestrian connection along Webster Street by utilizing a combination of limited vehicular drives and a grand staircase to a mid block plaza

### 3.10.1 Types of Alleys

Alleys may be public or private and may take the following forms:

- » Type 1: A driveway that serves vehicles and pedestrian and is designed to provide pedestrian connectivity. In this case alleys shall be well designed public spaces that are welcoming and clearly open to the public. They shall be pedestrian scaled and provide safe and pleasant connections through a block.

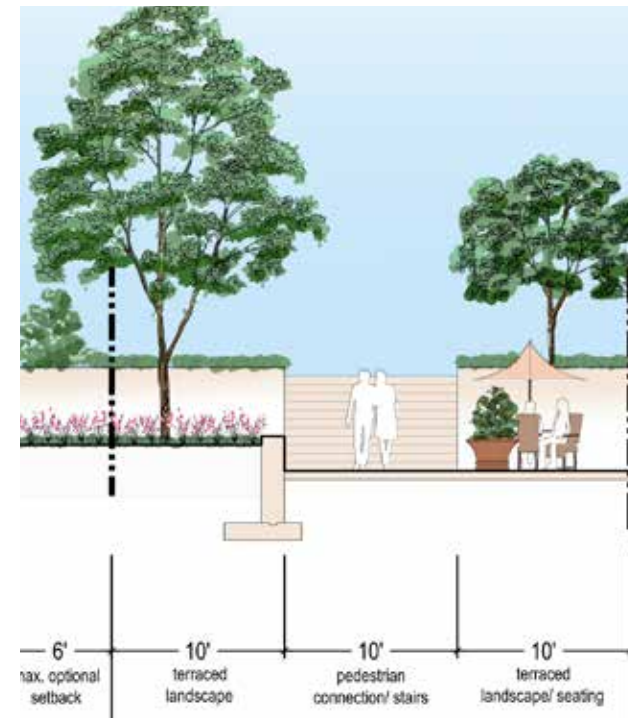

FIGURE 3.44 Private Alley: Pedestrian Path and Emergency Access

- » Type 2: A service alley primarily for vehicular use to service the block or access parking.

The images below describe these two alternatives for the design of alleys. These alleys may have secondary commercial frontage along them (as shown in Figure 3.31) or may simply service the back of buildings as described in Figure 3.32.

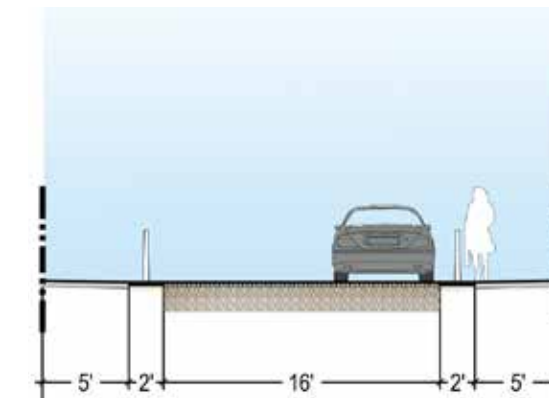

FIGURE 3.45 Private Alley: Two-Way with Bollards and No Curb

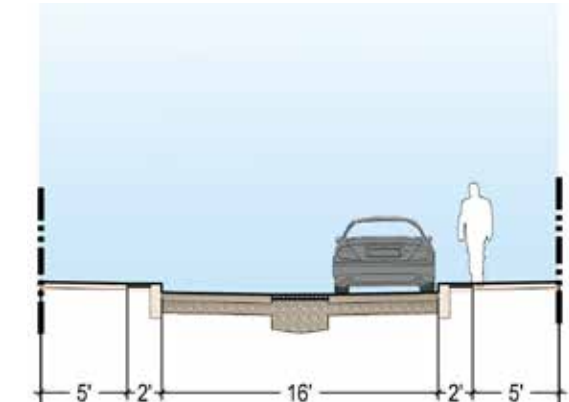

FIGURE 3.46 Private Alley: Two-Way with Curb



# Section 4. Building Types

Sec. 4.1 Introduction 55  
Sec. 4.2 General Regulations 56  
Sec. 4.3 Building Materials and Systems 57  
Sec. 4.4 Building Elements 58  
Sec. 4.5 Type I Buildings 59  
Sec. 4.6 Type II Building 60  
Sec. 4.7 Type III Building 61

## SUSTAINABILITY GOALS



- » Design and orient buildings for optimum use of passive solar strategies prior to active solar strategies
- » Design and construct energy efficient, high performance envelopes for energy use optimization
- » Design and construct building automation and control systems to intelligently reduce energy consumption
- » Design and construct vegetated roofs and/or reflective/cool roofs, specifying high albedo materials to reduce cooling system costs and reduce the urban heat island effect
- » Specify energy efficient light fixtures with long life spans to reduce energy consumption and maintenance cost and waste
- » Specify locally manufactured and extracted materials with recycled or reclaimed content
- » Specify solar panels or other high SRI roof materials
- » Reduce construction waste by establishing an on-site construction waste recycling program. Promote reuse for temporary materials such as formwork, bracing, scaffolding, sidewalk protection, guard rails, etc. through the construction process.
- » Commission buildings in order to verify proper operations and compliance with performance goals

## APPLICABLE LEED-ND POINTS (2009 Standards)

- GIB Pre 1 — Certified Green Building
- GIB Pre 2 — Minimum Building Energy Efficiency
- GIB Pre 3 — Minimum Building Water Efficiency
- GIB Credit 1 — Certified Green buildings
- GIB Credit 2 — Building Energy Efficiency
- GIB Credit 3 — Building Water Efficiency
- GIB Credit 4 — Water-Efficient Landscaping
- GIB Credit 8 — Stormwater Management
- GIB Credit 9 — Heat Island Reduction: Roof Measures
- GIB Credit 16 — Solid Waste Management



## Sec. 4.1 Introduction

There are three Building Types that guide the exterior design of buildings in the Lower Hill Redevelopment Site. All Building Types are permitted throughout the Site provided that they otherwise comply with all applicable regulations, including height requirements and frontage types.

Each building will fall into one of the three Building Type categories. The facade articulation and building composition components of a building will be governed by the requirements applicable to that Building Type (found in Sections 4.5–4.7 below).

The building types are as follows:

- » Type I: These buildings take the form of attached houses or stacked townhouses. This building type has a simple massing that is typically three to four stories tall and can be expressed in a variety of ways. This type may take the form of traditional attached townhouses (single units that are attached in a row), stacked townhouses (two units per building) or a flat stacked over a townhouse (two units per building).
- » Type II: These buildings range from 3 to 12 stories. A range of uses can work in this type and a mixed-use program is encouraged. On the smaller end of the scale this might take the form of a neighborhood apartment building with a compact footprint, making it ideal for handling steep topography. The larger end of the scale might be a large floor plate office building or institutional user that could have other commercial uses on the ground floor. This building type is intended to be built in Sub District 2.
- » Type III (Tower Building): The regulating plans allow for tall buildings in particular locations within Sub District 2. These are ideal corporate office towers and residential condos or apartments but can also be mixed-use buildings. The regulations provided here apply for towers above twelve stories.



FIGURE 4.1 Example of an Attached House displaying a mix of facade designs and materials.



FIGURE 4.2 Example of a Mid-Rise Building containing a mixed-use program.



FIGURE 4.3 Example of a Tower Building designed for residential condos.



## Sec. 4.2 General Regulations

The following information and regulations apply to each Building Type and should be carefully considered during the design process of any building.

### 4.2.1 Goals and Regulations

- » All buildings shall be designed as urban buildings that face the street, respect frontage requirements, and meet the standards set forth herein to ensure a high quality built environment.
- » All buildings shall conform to all applicable local and national building codes as well as any applicable accessibility (ADA) requirements.
- » All buildings should strive to be responsible, sustainable buildings. LEED-ND certification at the then current version is a recommendation, but at the very least, each building should perform to the degree that it contributes to the goals of the district as a whole (i.e.: LEED-ND minimum requirements). Sustainable buildings should include sustainable materials, energy efficient systems, minimize heat island effect, mitigate the effects of stormwater and promote healthy living and working environments.
- » Two LEED-ND prerequisites pertaining to the design of buildings are highlighted in the box to the right. These are of utmost importance and the responsibility of private developers in order for the district as a whole to achieve LEED-ND certification.
- » All buildings should include occupiable roof decks, terraces, and facades (balconies, step backs) to promote activity at all levels. The topography of the site allows for unique views to Downtown and the surrounding neighborhoods, therefore these elements will permit occupants to take full advantage of location and climate.
- » Building Height shall be defined as presented in the Pittsburgh Zoning Ordinance, as follows:
  - › Building Height means the vertical distance between Average Finished Grade along the wall facing the front street yard and:
    - › (a) the highest point of the coping of a flat roof;
    - › (b) the deck line of a mansard roof; or
    - › (c) the average height level between the eaves and ridge line of a gable, hip or gambrel roof.
- » See following sections for further information: 925.07.A – Measured in Feet; 925.07.B – Measured in Stories; 925.07.C – Exemptions from Height Standards
- » Art is encouraged to be an integral component of buildings and Urban Open Space.

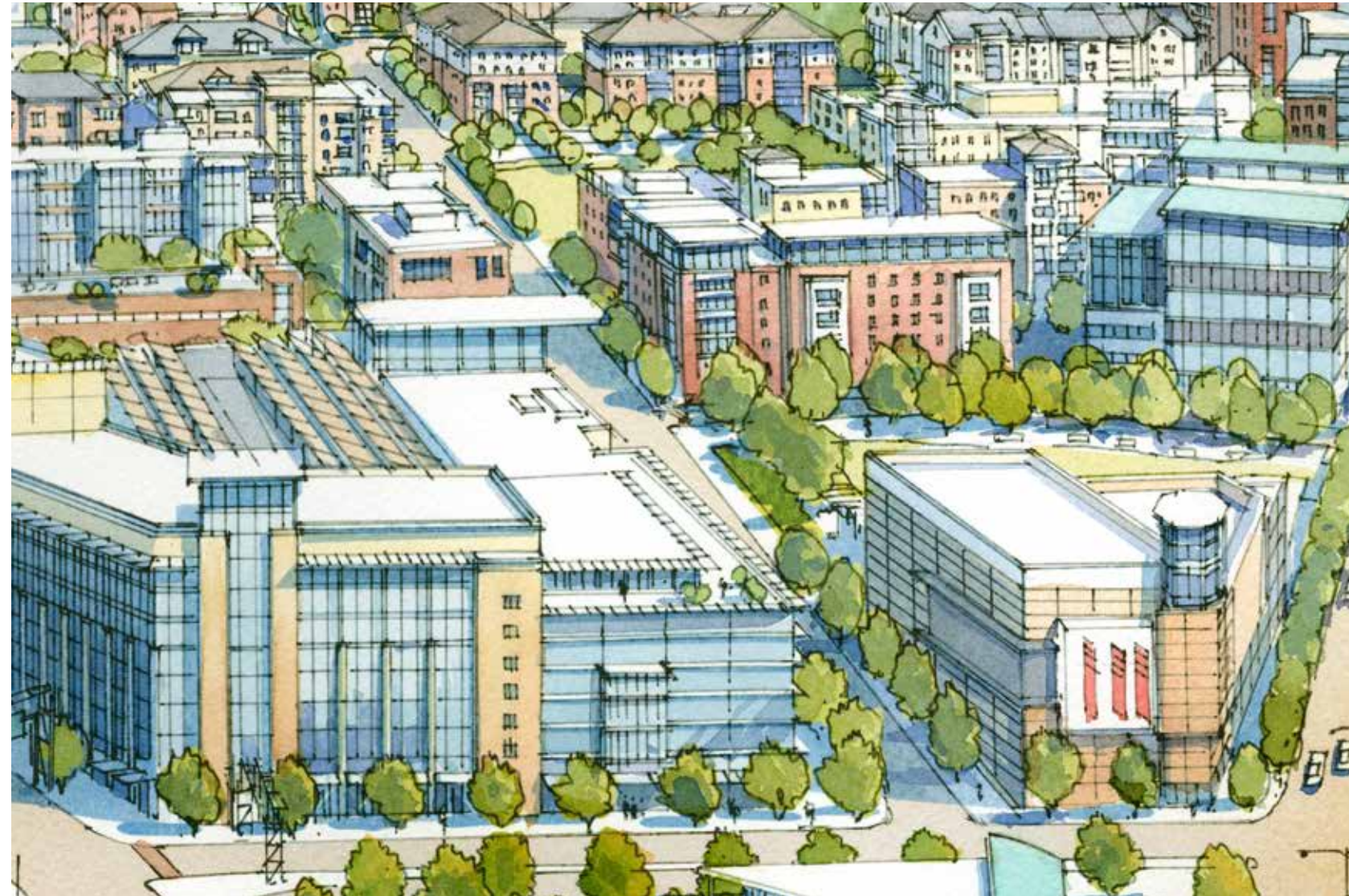

FIGURE 4.4 Illustration of the potential variety of building types

#### LEED-ND PREREQUISITES

- » Achieve 10% energy savings over an ASHRAE 2007 baseline
- » Achieve indoor water use savings to be 20% over an Energy Policy Act of 2005 baseline
- » Note: as standards evolve, projects should meet the most current standards at the time of certification



## Sec. 4.3 Building Materials and Systems

Building material and system selection is a key component in creating a sustainable community that achieves LEED-ND certification. In selecting materials, priority should be given to materials that have the following attributes:

- » composed of recycled or reclaimed content
- » locally manufactured
- » high performance

### SUSTAINABLE BUILDING MATERIALS & SYSTEMS



#### Building Envelope

- » Use highly efficient wall and roof materials to increase insulation values and reduce heating and cooling costs. Use impermeable insulation to better seal the building envelope.
- » Use reflective roof materials to reduce cooling loads and heat island effects.
- » Use proper building seals in the building envelope to reduce heating and cooling costs caused by air infiltration.
- » Encourage Building Envelope Commissioning (BECx) in order to verify building performance and neighborhood energy performance goals

#### Daylighting

- » Use insulating windows to conserve electricity and reduce heating and cooling costs.
- » Use insulated skylights to increase daylighting and to conserve electricity and reduce heating and cooling costs.

#### Illumination

- » Use energy efficient light fixtures with long lifetimes to reduce energy consumption, maintenance cost, and waste.
- » Use of lighting control systems to manage lighting levels in occupied spaces for optimum energy performance and occupant comfort

#### Intelligent Building

- » Use building automation and control systems to intelligently reduce energy consumption.
- » Use circuit protection to enhance the lifetime of electrical components.
- » Use intelligent electrical distribution equipment to manage energy usage and reduce electricity consumption.
- » Use electric vehicle charging stations.
- » Use power quality equipment to enhance the lifetime of electrical components and reduce energy consumption.
- » Use highly efficient transformers to reduce energy consumption.

#### HVAC

- » Adapt HVAC systems to reduce energy consumption and extend lifetime of HVAC motors by using variable frequency drives.
- » Encourage Building Envelope Commissioning (BECx) in order to verify building performance and neighborhood energy performance goals.
- » Select environmentally friendly refrigerants.

#### Indoor Environment Quality

- » Use durable high performance coatings, adhesives and sealants with low VOCs.
- » Implementation of IAQ Management Plans during construction to encourage clean construction practices.

The following materials list is intended to regulate material selection from aesthetic and quality aspects. All buildings will be finished on all four sides with approved cladding and with architectural detailing consistent with the rest of the building. Compliance is required and will be reviewed as part of the planning review process. Any materials not listed below shall be evaluated by both the property owner and applicable City review bodies for quality and appropriateness. These unlisted materials shall be either approved or prohibited on a case by case basis.

- » Cladding
  - » Permitted: Brick, stone, cast stone, precast concrete, terracotta, fiber cement, painted wood, metal, composite or polycarbonate panel systems, aluminum or fiberglass frame curtain wall and glass or polycarbonate glazing, vegetated cladding systems, metal panels
  - » Prohibited: Vinyl siding, simulated stone veneer, EIFS
- » Roofing
  - » Permitted: Flat roofing systems, standing seam roofing, corrugated metal, slate (including manufactured slate products), architectural asphalt shingles, cast stone or precast parapets, skylights, polycarbonate and glass atrium systems, vegetated roofing systems, solar panel systems
  - » Prohibited: Asphalt shingles
- » Window Walls & Commercial Streetfronts
  - » Permitted: Aluminum framing system with glass, spandrel glass with aluminum or composite spandrel panels, subject to transparency requirements in Sections 4.5–4.7.
  - » Prohibited: Vinyl siding & trim.
- » Windows
  - » Permitted Frames: Wood, Cellular PVC, Aluminum and fiberglass window systems
  - » Permitted Glazing: Clear and lightly tinted glass and polycarbonate, spandrel glass
  - » Prohibited: Vinyl frames, mirrored glass, heavily tinted glass
- » Light Shelves and Sun Shades
  - » Permitted: Prefinished aluminum (solid or louvered), cast stone, concrete
  - » Prohibited: None

- » Trim
  - » Permitted: Stone, cast stone, and stone string courses, lintels and sills; fiber cement, wood, composite millwork
  - » Prohibited: Vinyl, EIFS
- » Columns
  - » Permitted: Stone, cast stone, precast concrete, brick, glass fiber-reinforced cement, aluminum, steel, naturally finished outdoor hardwood, painted wood, fiberglass
  - » Prohibited: None
- » Balconies
  - » Permitted: Railings: steel, aluminum, wood, fiberglass, composite, glass and polycarbonate railing systems; Balcony floors: stone, cast stone, concrete, naturally finished outdoor hardwood, painted wood, composite faced
  - » Prohibited: Exposed pressure treated wood
- » Soffits
  - » Permitted: fiber cement, prefinished aluminum, painted wood, or smooth surface composition board
  - » Prohibited: Vinyl, exposed pressure treated wood
- » Canopies
  - » Permitted: Metal, glass and polycarbonate, painted wood or composite (Note that fabric Awnings are distinguished from Canopies)
  - » Prohibited: None



FIGURE 4.5 Example of curtain wall corner element



FIGURE 4.6 Example of permitted curtain wall



FIGURE 4.7 Example of aluminum shading elements



FIGURE 4.8 Example of storefront with metal canopy



## Sec. 4.4 Building Elements

The Building Elements outlined here are important pieces of every building and certain aspects of these are regulated so as to ensure buildings are designed and operate in a responsible manner.

### 4.4.1 Lobby Entrances

Lobbies serve as the primary entrance into a commercial or residential building. To ensure their effectiveness, the following minimum criteria shall be met:

- Lobby entrances shall be articulated such that how and where to enter the building is clear and unobstructed from the street.
- Commercial lobbies shall provide a minimum of 60% facade transparency along a street facing into the internal lobby space measured between grade and the ground level ceiling height. Transom and clerestory windows count toward the minimum transparency.
- Residential lobbies shall provide a minimum of 40% facade transparency along a street facing into the internal lobby space to ensure visibility and safety. Transom and clerestory windows count toward the minimum transparency measured between grade and the ground level ceiling height.
- Lobbies shall be appropriately accessible for persons with disabilities from locations in the rear, nearest to the reserved accessible parking.
- Lobby entrances shall be well lit while not exceeding the lumen and cutoff standards set forth in Section 5.4.1 Building Lighting.



FIGURE 4.9 Example of a clearly articulated entry with a canopy element and clear building signage.

- Lobbies shall clearly show the address and name of the building consistent with the signage standards set forth in Pittsburgh zoning code title nine: Zoning Code, Article VI, Development Standard, Chapter 919: Signs.

### 4.4.2 Mechanical and Other Building Systems

- Rooftop equipment shall not exceed a projecting height of more than 25% of the building type's permitted height or 20 feet, whichever is least. Rooftop equipment shall be setback from edge of roof or parapet by a minimum of 10 feet. Additional screening should be provided when active space is provided on rooftops of buildings in close proximity to each other. Screening should be an important consideration on buildings lining view corridors, and should be for both visibility and noise.
- The form of the roof or cornice shall hide mechanical equipment and roof penetrations, such as plumbing stacks and vents, from view from streets and sidewalks.
- Vents, grilles, and louvers required on building facades for mechanical systems shall be architecturally integrated into the facade design.
- Mechanical equipment (such as electric transformers) shall be screened such that it is not visible from streets, alleys, or Urban Open Space. Strategies for meeting these requirements includes installing such equipment within a parking structure or by screening it with a hedge-row or fence on all publicly exposed sides. Screening elements shall be as tall as the equipment mass or six feet, whichever is greater. For commercial buildings, electrical transformers and generators must be located within the building or underground. However, small mechanical equipment (such as water and gas meters) does not need to be placed underground or within a building provided the screening requirements of this section are satisfied.

### 4.4.3 Penthouses and Towers

- Penthouses and towers provide rooftop access, view and entertainment venues, as well as visual markers within the city. Penthouses generally provide rooftop access and house building mechanical equipment. Towers can range from a raised parapet on part of a building's roofline to a fully accessible vertical element. If penthouses or towers are greater than 50% of the width or depth of a main body facing either a front- or side-street yard, the penthouse or tower shall be stepped back a minimum of 10 feet from the building's facade.

### 4.4.4 Commercial Streetfronts

Commercial Streetfronts are the traditional means of advertising goods, services, and enterprises along streets and public spaces. Commercial street standards should be applied to Type II and Type III buildings when the ground level of such buildings is dedicated to commercial use to improve the performance of the commercial ventures within.

- Commercial Streetfronts are typically tall with a high percentage of glazing to allow for maximum visibility and opportunities for signage. Refer to Section 4.5 to 4.7 for transparency requirements based on each building type.
- Commercial Streetfronts along the ground floor of a building shall be designed to permit maximum flexibility for subdividing commercial spaces.
- When at corners, entrances should be located at the building's corner to maximize commercial visibility from multiple directions.
- Commercial Streetfront entrances shall be clearly distinguished from those serving floors above.
- Commercial Streetfronts may be individualized as part of tenant fit out including, but not limited to signage, lighting, paint color, landscaping, window and door style, and detailing.
- Within the structural framework of the Commercial Streetfront, Commercial Streetfronts may be composed of various types of operational doors and windows that allow the opening up of interior spaces onto the side-



FIGURE 4.10 Example of a small penthouse that provides access to a rooftop terrace.



FIGURE 4.11 Canopies can help to define lobby entrances.



## Sec. 4.5 Type I Buildings

Type I buildings take the form of attached houses or stacked townhouses. This building type has a simple massing that is typically three to four stories tall and can be expressed in a variety of ways. This type may take the form of traditional attached townhouses (single units that are attached in a row), stacked townhouses (two units per building) or a flat stacked over a townhouse (two units per building). The facade may reflect individually articulated units, or may be composed of a series of units. For a row of more than three buildings, the facade must be composed architecturally in order to avoid long expanses of unarticulated facades. The typical characteristics of this building type are highlighted below:

- » Main body width: 16 to 32 feet
- » Ground story height (floor to floor): 10 feet
- » Upper story height (floor to floor)
- » Residential: 9 feet typically

If a building meets the Type I Building characteristics, it shall comply with the massing, facade articulation and building composition requirements in the tables below.

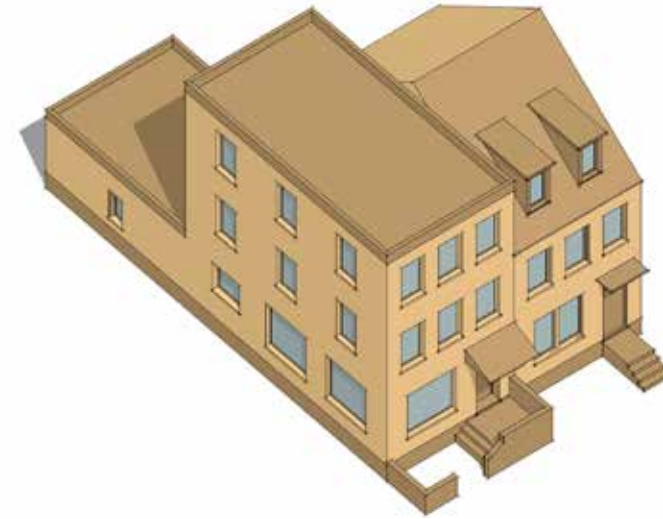

FIGURE 4.12 Massing and Composition



FIGURE 4.13 Attached Houses may have an elevated entry to provide some separation from street activity.



FIGURE 4.14 On end units corners may be emphasized through wrapping windows or wrap around porches.



FIGURE 4.15 Example of Type I building in a townhouse form with decorative bays and balconies



FIGURE 4.16 This building type may range from individual townhouse units, to stacked townhouses and flats

TABLE 4.1 Facade Articulation Requirements

Vertical Articulation	
Full facade height bays are encouraged at corners	
Facades over 24 feet wide shall include a plane break and or material change to enhance the vertical articulation	
Horizontal Articulation	
The building shall be defined by a base middle and top using window composition, ornament and special architectural features	
Residential entries should be raised 2-3 feet when possible and take the form of a stoop or porch; the porch floor sets the base line	
The middle is characterized by residential windows	
The top can be articulated by varying roofline and/or cornice lines to define a skyline profile	

TABLE 4.2 Building Composition Requirements

Transparency		
	min.	max.
Ground level (min.)	30%	30%
Upper story (min.)	30%	30%
Blank wall width (max)	n/a	12'
Transparency requirements to apply to all facades facing a street or urban open space		
Transparency is calculated as a percentage of the wall surface of a particular story, and has no limitation as to its location within the wall surface		
Building Elements		
Architectural elements such as punctuated doorways, bay windows, balconies, and decorative eaves and cornices are recommended to provide human-scale buildings		



## Sec. 4.6 Type II Building

These buildings are three to twelve story urban buildings that can house residential, office or commercial uses either in a mixed-use format or as a single use. The charts to the right list key requirements for this building type.

These buildings should have simple massing while incorporating human-scale elements (such as ground floor commercial street fronts) that responds to the urban context. The typical characteristics of this building type are highlighted below:

- » Main body width: 32 to 280 feet
- » Ground story height (floor to floor)
  - › Residential: 10 feet
  - › Non-residential: 14 feet to 18 feet
- » Upper story height (floor to floor): 9 feet typically
- » Roof pitch (rise : run): flat roof or 15 : 12

If a building meets the Type II Building characteristics, it shall comply with the massing, facade articulation and building composition requirements in the tables below.

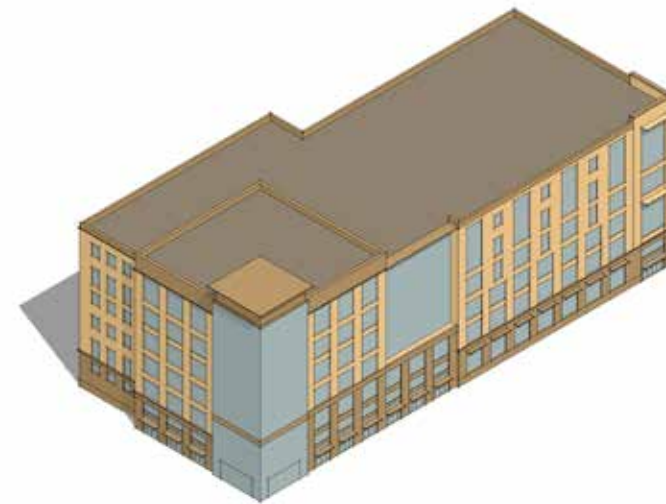

FIGURE 4.17 Massing and Composition

TABLE 4.4 Massing Requirements

Building depth: <ul style="list-style-type: none"> <li>• Standalone building: 55 feet</li> <li>• Liner building: 35 feet</li> </ul>
Ground floor level (floor to floor): 18 feet max. Note: Exceptions may apply, see SP-11 Zoning Text.



FIGURE 4.18 Example of how vertical bays are articulated through a change in materials, and a change in plane.

TABLE 4.5 Facade Articulation Requirements

<b>Vertical Articulation</b>	
Vertical bays shall be articulated at a minimum of 45 feet and a maximum of 120 feet in width	
If an element is greater than 60 feet, it shall be further subdivided	
Each vertical element may be distinguished by one of the following: Material, color, architectural style, height, window type, facade composition, commercial streetfront or entry type	
All primary street frontage corners should maintain a 0-foot setback for a minimum of 25 feet in both directions. 45 degree angled facades are permitted at street-facing corners as long as the angled facade is not longer than 15 feet.	
<b>Horizontal Articulation</b>	
The building shall be defined by a base, middle and top using window composition, ornament and special features to accomplish this	
For mixed-use buildings, ground floor commercial streetfronts should sit at grade wherever possible.	
The middle is characterized by a continuous pattern of windows	
The top can be articulated by varying roofline and/or cornice to define a skyline profile	



FIGURE 4.19 Corner elements enhance the composition of a building and may also be used to terminate vistas.

TABLE 4.6 Building Composition Requirements

<b>Transparency</b>		
	min.	max.
Ground story (min.)	50%	100%
Upper story (min.)	30%	100%
Blank wall width (max)	n/a	30 ft.
Entrance Doors are located in appropriate and prominent locations		
Transparency is calculated as a percentage of the wall surface of a particular story, and has no limitation as to its location within the wall surface		
<b>Architectural Elements</b>		
Architectural elements such as punctuated doorways, bay windows, balconies, and decorative eaves and cornices are recommended to provide human-scale buildings		



## Sec. 4.7 Type III Building

Tower Buildings are defined as being taller than twelve stories and in some locations within the site have no maximum height requirement. The charts to the right list key requirements for this building type.

In order to protect view corridors, the regulating plans allow for tall buildings in particular locations as identified in Section 2.8. These buildings can contain a variety of uses including office, residential, hotel and /or commercial and retail. While towers are more vertical in nature, the facade should still maintain vertical articulation and a clear sense of a base, middle, and top. Towers are typically characterized by the following:

- » Typical width: 55 to 100 feet
- » Typical depth: 225 to 250 feet
- » Ground story height (floor to ceiling):
  - › Residential: 10 feet
  - › Non-residential: 14 feet to 18 feet
- » Upper story height (floor to floor): 10 feet min
- » Roof pitch (rise:run): flat or 8:12

If a building meets the Type III Building characteristics, it shall comply with the massing, facade articulation and building composition requirements in the tables below.

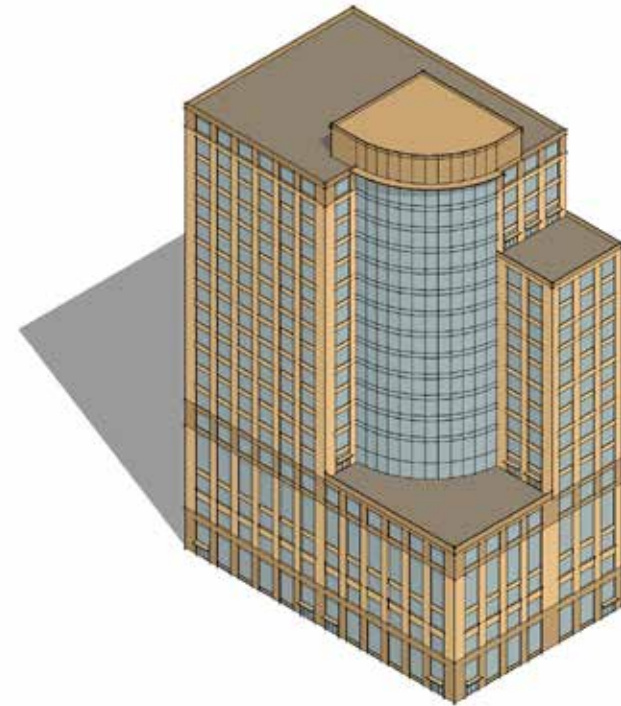

FIGURE 4.20 Massing and Composition

TABLE 4.8 Massing Requirements
Ground level height (floor to floor): 24 feet max. Note: Atria may exceed that allowance as an exception



FIGURE 4.21 Tower composition broken composed of vertical elements.

TABLE 4.9 Facade Articulation Requirements
<b>Vertical Articulation</b>
For towers, no single element or plane shall be wider than 100 feet on the main tower
The base shall be articulated with each element at a minimum of 24 feet wide and a maximum of 60 feet wide
<b>Horizontal Articulation</b>
Define base middle and top * may use window composition, ornament and special feature to accomplish this
For mixed-use buildings, ground floor retail commercial streetfronts should sit at grade wherever possible.
The top can be articulated by varying roofscaped to enrich the facade of the street



FIGURE 4.22 Tower composition broken composed of vertical elements.

TABLE 4.10 Building Composition Requirements	min.	max.
<b>Transparency</b>		
Ground story (min.)	50%	100%
Upper story (min.)	30%	100%
Blank wall width (max)	n/a	30 ft.
Transparency requirements to apply to all facades facing a street or urban open space		
When glazing consists of more than 50% in a contiguous area of any one facade, it must vary in appearance in the following ways: surface articulation, change in color, pattern (fritting) over 40% of the glazed area.		
Doors are located in appropriate and prominent locations		
Transparency is calculated as a percentage of the wall surface of a particular story, and has no limitation as to its location within the wall surface		
<b>Architectural Elements</b>		
Architectural elements such as punctuated doorways, bay windows, balconies, and decorative eaves and cornices are recommended to provide human-scale buildings		



# Section 5. Signage Regulations

Sec. 5.1 Signage 63



**SUSTAINABILITY GOALS** 

- » Specify regionally/locally manufactured and extracted, recycled and reclaimed materials
- » Specify energy efficient fixtures such as street lights, traffic lights, etc to reduce energy consumption for operating public infrastructure

**APPLICABLE LEED-ND POINTS (2009 Standards)**

- GIB Credit 13 — Infrastructure Energy Efficiency
- GIB Credit 15 — Recycled Content in Infrastructure
- GIB Credit 17 — Light Pollution Reduction



## Sec. 5.1 Signage

- (i) All non-advertising signs permitted in LNC Districts pursuant to Chapter 919 shall be permitted in Sub-district 1 of the SP-11 Lower Hill Planned Development District.
- (ii) All non-advertising signs permitted in GT Districts pursuant to Chapter 919 shall be permitted in Sub-districts 2 and 3 of the SP-11 Lower Hill Planned Development District.
- (iii) The provisions of Chapter 919.03.P shall apply to Major Public Destination Facility Electronic Signs in the SP-11 Lower Hill Planned Development District, except as modified below:
  - » (1) A Major Public Destination Facility Electronic Sign that is classified as a Large Video Display shall be located (A) on the same parcel as the Major Public Destination Facility or (B) within or directly adjacent to a Major Public Destination Facility Plaza, provided such sign is under the control of the primary occupant of the Major Public Destination Facility.
  - » (2) A Major Public Destination Facility Electronic Sign that is not classified as a Large Video Display shall be located within 1000 feet from the property line of Major Public Destination Facility lot, provided that such sign (A) shall be located within the SP-11 Lower Hill Planned Development District, (B) shall not be located within 100 feet from Sub-district 1, (C) shall not be located within or adjacent to urban open space directly abutting Sub-district 1, and (D) shall be under the control of the primary occupant of the Major Public Destination Facility.
  - » (3) A Major Public Destination Facility Electronic Sign that is not classified as a Large Video Display and which is not located on the same parcel as a Major Public Destination Facility shall be presented to the Contextual Design Advisory Panel (CDAP) for design review. Such review shall include the design, location and visual impacts of the proposed sign.
  - » (4) There shall be permitted up to two (2) Major Public Destination Facility Electronic Signs that are classified as Large Video Displays in the SP-11 Lower Hill Planned Development District, provided that at least one (1) such sign is located on the same parcel as the Major Public Destination Facility. There shall be permitted no more than one (1) Major Public Destination Facility Electronic Sign that is not classified as a Large Video Display.

- » (5) The name, logo and identifying mark of a sponsor of (A) any event occurring at the Major Public Destination Facility and/or (B) the Major Public Destination Facility itself or memorialized names assigned thereto shall be permitted to be displayed on a Major Public Destination Facility Electronic Sign, subject to the following limitations:
  - › (i) Products or services of a sponsor shall not be displayed.
  - › (ii) The period of time during which such sponsor information is displayed shall not exceed fifteen percent (15%) of the time period during which the sign is actively operated.
  - › (iii) The name, logo and identifying mark of a sponsor shall not exceed fifteen percent (15%) of the sign area.
  - › (iv) If a logo or identifying mark is displayed, it shall be displayed simultaneously with the name of the sponsor. A logo or identifying mark that is not accompanied by a sponsor name shall not be permitted to be displayed.

The term “Major Public Destination Facility Plaza” means an area of land containing at least one (1.0) acre designated as urban open space and located adjacent to and/or across a public right-of-way from a Major Public Destination Facility.

For clarification, the term “parks” as used in Chapter 919.03.P5(a) shall not include urban open space.



FIGURE 5.1 Diagram illustrating potential locations for the Major Public Destination Facility Electronic Sign (shown in yellow)



FIGURE 5.2 Photo of original marquee sign in front of the Civic Arena (to be replaced by the Major Public Destination Facility Electronic Sign)



FIGURE 5.3 Example of an facility electronic sign



# Development Guidelines: Sections 6–9

## Section 6. Supplemental Guidelines

Sec. 6.1 Introduction	69
Sec. 6.2 Sidewalk Cafes	70
Sec. 6.3 Lighting	71
Sec. 6.4 Materials	72
Sec. 6.5 Site Furnishings	73

### SUSTAINABILITY GOALS

- » Provide safe, convenient, and comfortable transit-waiting areas
- » Provide safe and secure bicycle storage facilities
- » Specify dark sky compliant lighting and energy efficient technologies
- » Specify regionally/locally manufactured and extracted, recycled and reclaimed materials
- » Specify energy efficient fixtures such as street lights, traffic lights, etc to reduce energy consumption for operating public infrastructure

### APPLICABLE LEED-ND POINTS (2009 Standards)

- NPD Credit 7 — Transit Facilities
- GIB Credit 13 — Infrastructure Energy Efficiency
- GIB Credit 15 — Recycled Content in Infrastructure
- GIB Credit 17 — Light Pollution Reduction





## Sec. 6.1 Introduction

This section offers guidelines that should be taken into consideration when developing the Site. These guidelines are intended to develop the Lower Hill Redevelopment Site as a cohesive place. This section addresses standards and recommendations for the following:

- » Sidewalk Cafes
- » Lighting
- » Site Furnishings



FIGURE 6.1 Perspective showing the intended character of Wylie Street with richness and cohesiveness in signage, lighting, materials, and furnishings.



## Sec. 6.2 Sidewalk Cafes

### 6.2.1 Amendments to Sidewalk Cafe City Standards

In most cases, Sidewalk Cafes are located within public streets and therefore, users must adhere to the existing City of Pittsburgh’s Department of Public Works Sidewalk Cafe and/or applicable encroachment standards. Additional, special standards for this district are as follows:

- » Cafe areas shall maintain a minimum 5-foot clear pedestrian path along the sidewalk between cafe enclosure and adjacent tree planter or other fixed element.
- » Cafe areas shall be defined with enclosures, which may include railings and fencing. If the cafe is located adjacent to the restaurant /cafe storefront, temporary or semi-permanent, perpendicular (to the storefront) enclosures shall extend the depth of the outdoor dining area. Parallel to the building, a temporary enclosure shall be used to keep the cafe from spilling into the clear sidewalk zone. Cafes along the curb shall be defined by temporary enclosures.
- » In all cases the enclosures shall be removable and may take the form of removable rope and stanchion, planters, panels or other temporary devices such as fences. High quality components should be used; plastic is prohibited.

### 6.2.2 Sidewalk Cafe – Locations and Design

The design of sidewalk cafes is an integral part of neighborhood character and should be coordinated with building signage and streetscape elements. Various streetscape conditions will be located within the Lower Hill Redevelopment Site. The street type plan in the Regulating Plans section describes the differences between intended residential and mixed-use streets. The goal of these guidelines is to promote a cohesive atmosphere for the pedestrian as they traverse the site.

In the case of the retail streets, the streetscape elements also should be carefully designed to encourage sidewalk cafes. The following are general considerations for retail streets:

- » Retail, restaurant, and other food and beverage operators are encouraged to design and operate exterior sidewalk areas in a manner that will create a seamless connection from their interior operation to the exterior spaces.

- » At sidewalk setback locations, storefront designs that reinforce the connection between inside and outside are encouraged. Storefront designs can use operational doors and windows that allow for direct connection and movement between the sidewalk and restaurant or shop interiors.
- » The use of outdoor plantings, planting boxes, and flower boxes is recommended in the sidewalk setback areas.
- » Awnings, canvas umbrellas, and heat lamps may be used to extend the seasonal use of sidewalk areas but must be contained within the defined cafe space.

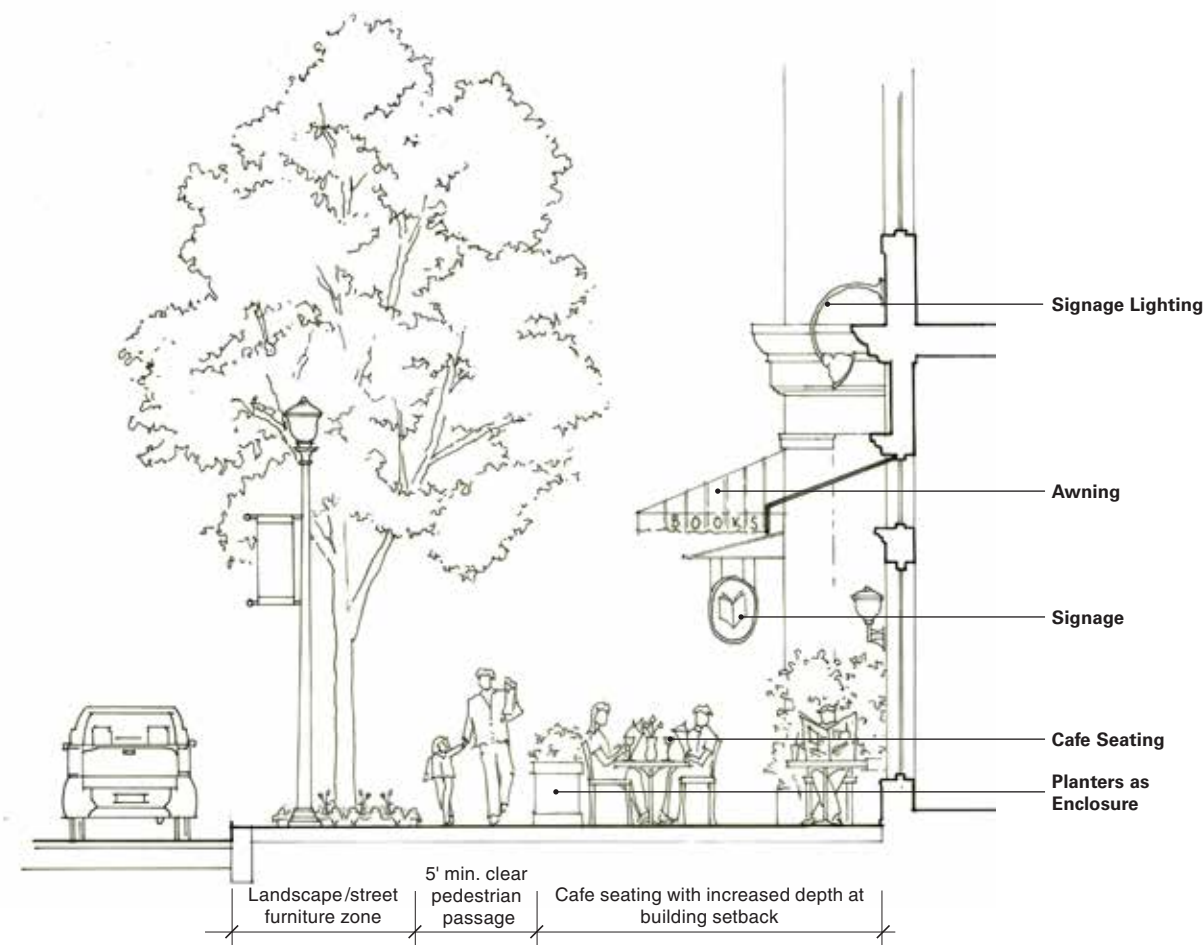

FIGURE 6.2 Section diagram illustrating streetscape elements

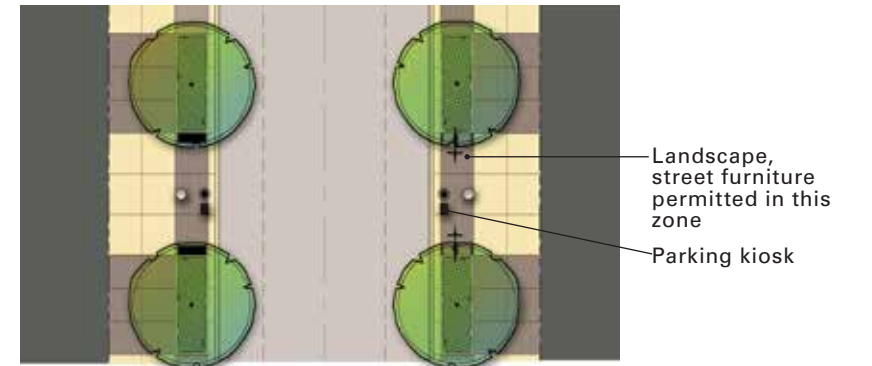

FIGURE 6.3 Plan view of landscape/street furniture zone between street trees.



FIGURE 6.4 Streetscape that accommodates outdoor dining, a clear pedestrian passage, and landscaping.



FIGURE 6.5 Example of planters used as an enclosure for an outdoor cafe.



FIGURE 6.6 Example of outdoor cafe spaces on a sloping street.



## Sec. 6.3 Lighting

### 6.3.1 Building Lighting

Lighting in this district will be subject to the City Code Ordinance No.8, Chapter 1201 Lighting Code, which was updated in April 2011 and as amended. This document outlines guidelines for lighting performance, yet does not specify particular fixtures and types. Although the primary consideration for building lighting shall be performance, it is encouraged that lighting be well designed and a critical component of building design. The photos below illustrate the variety of potential light fixtures and styles. Some general considerations are listed below.



FIGURE 6.7 Examples of wall mounted lighting

### 6.3.2 Site Lighting – General Requirements

In addition to the building lighting, site lighting plays a major role in setting the tone for creating an enjoyable atmosphere within the development. Public safety is of utmost importance when designing the site lighting. Various types of lighting and locations shall be permitted throughout the development. Each of the fixtures chosen for this district will need to adhere to the following criteria (\* Credit: Pittsburgh LED Street Light Research Project):

- » Light color should be white, preferably 3,500 Kelvin, but with any adjustable range from 2,800 to 5,000 Kelvin.
- » The Color Rendering Index should be 80 or greater.
- » The fixtures should be primarily down-firing. Up-firing fixtures, if used for aesthetic effect, shall be aimed at white horizontal reflectors to produce diffused light downward to prevent Dark Sky intrusion.
- » The LED source should not be visible to drivers, bicyclists, or pedestrian unless they are directly under the fixture.
- » LED luminaires should be guaranteed for a minimum ten-year life span with no more than a 30% deterioration of luminance as measured by footcandles.

- » The lighting pattern on the ground should be overlapping ovals.
- » Typical spacing for luminaires on 25-foot to 30-foot poles may vary from 85 feet to 150 feet. On 15-foot to 18-foot poles the spacing should be approximately 80 feet. For each installation, the developer shall obtain a photometric study to ascertain the appropriate spacing based on the specific fixture and site condition.
- » All luminaires should be control-ready with the ability in the future to be individually monitored and controlled by wired or wireless central networks.
- » Back-lighting of building facades shall not exceed a height of 6 inches above the sidewalk.
- » Luminaires design shall be compatible with the local context.
- » All luminaires should be directed inward to eliminate excess light from spilling onto adjacent parcels by using cut-off or asymmetrical fixtures.

### 6.3.3 Site Lighting – Within the Public Right-of-Way

- » City of Pittsburgh approved pedestrian and street light poles, traffic signal poles, and bollards shall be used. Unified illumination, reduction of glare, and use of dark sky compliant fixtures are all priorities.
- » All fixtures should adhere to the requirements in Section 6.4.2.

### 6.3.4 Site Lighting – Within Open Spaces

- » Lighting proposed for any open space (including, without limitation Urban Open Space), should be comprehensively designed with a mixture of light fixtures that complement the landscape setting and uses of the open space. Pedestrian scale light fixtures, bollards, and decorative wall /ground lighting are acceptable. Artistic solutions for lighting are encouraged.
- » All fixtures shall adhere to the requirements in Section 6.4.2.

### 6.3.5 Site Lighting – Within the Development Blocks

- » Lighting in the development blocks should be designed with flexibility regarding these guidelines and should be integrated into the development block's site, landscape, and building design.
- » All fixtures shall adhere to the requirements in Section 6.4.2.



FIGURE 6.8 Example of street/ pedestrian-scale LED post light that incorporates indirect light to comply with Dark Sky Regulations.



FIGURE 6.9 Example of City of Pittsburgh standard bollard.



FIGURE 6.10 Current City of Pittsburgh light fixture.



FIGURE 6.11 Example of LED pavement lighting — this type of application would be appropriate in Parks and Open Space and in the Development Blocks.

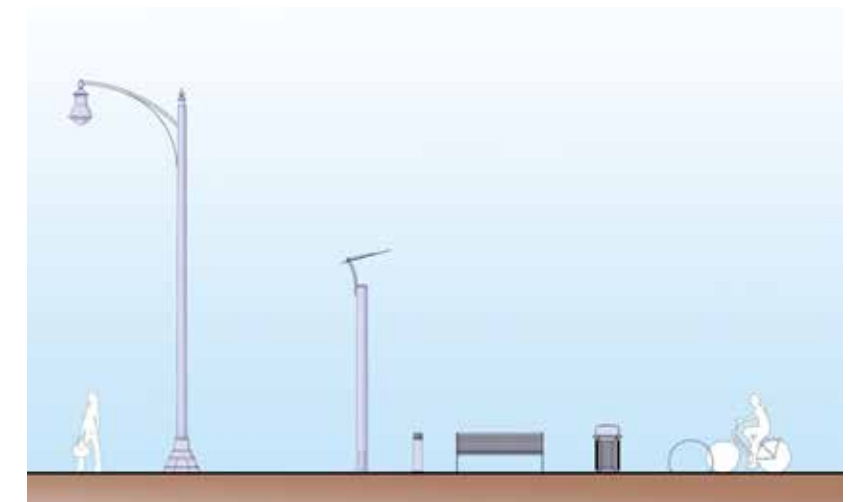

FIGURE 6.12 Streetscape kit of parts showing pedestrian and street level lighting standards, benches, trash receptacles, and bicycle racks.



## Sec. 6.4 Materials

### 6.3.6 Materials – Within Open Spaces

#### A. Paving Materials

- » For neighborhood unification, broom finish and exposed aggregate shall be the prominent material. At gathering points and activity areas, upgrade such as bluestone, sandstone or granite stone paving, concrete unit pavers, brick pavers, and other similarly types of materials shall be used.

#### B. Plant Materials

- » A native palette of shade trees, ornamental trees, shrubs, groundcovers, grasses, and perennials should be used. Refer to Section 6.4 Plant Palette.



FIGURE 6.13 Examples of native and drought tolerant plant palettes.

### 6.3.7 Materials – Within Development Blocks

#### A. Paving Materials

- » Within the Development Blocks, the most flexibility should be allowed offering a wide selection of paving materials that will provide an unified setting and compliment the overall aesthetic development of the building and site.

#### B. Plant Materials

- » A native palette of shade trees, ornamental trees, shrubs, groundcovers, grasses and perennials should be used. Refer to the plant palette page in Section 7 for specific species and topsoil mixture.



FIGURE 6.14 Example of cafe barriers using fence panels and moveable planters adjacent to the sidewalk. Note the permanent planter that holds the corner of the ROW line and reflecting the architecture of the building.



FIGURE 6.15 Example of barrier railings to control pedestrian traffic.



FIGURE 6.16 Example of contemporary, art-influenced barrier railings.



## Sec. 6.5 Site Furnishings

### 6.5.1 Furniture Within the Public Right-of-Way

This section includes standards for site furnishings in public rights of way that are intended to enhance existing City standards. Such site furnishings include bicycle racks, benches, trash /recycling receptacles, and bus shelters. For the convenience of the reader, the following page provides suggested, non-mandatory locations of site furnishings.

#### A. Seating

- » High quality and durable metal benches, with powder coat or stainless steel finishes, shall be used within the Public Right-of-Way. Benches, with backs or backless styles, shall be placed as to not block pedestrian flow and shall be integrated into, but not limited to, the tree planting verge. Benches can also be provided of a material that matches the tree verge materials.

#### B. Bicycle Racks

- » High quality and durable metal bicycle racks shall be installed at key areas throughout the neighborhood. Bicycle racks shall be placed as to not block pedestrian flow and should be integrated into, but not limited to, the tree planting verge.

#### C. Trash Receptacles

- » High quality and durable recycling and trash receptacles shall be used and combined receptacles are desired. Trash receptacles shall be placed as to not block pedestrian flow and shall be placed at street intersections and at convenient mid-block locations.

#### D. Bus Shelters

- » A high quality and durable Bus Shelters shall be placed at the designated location within the site. Free pedestrian flow around bus shelters shall be maintained.
- » Bus shelters can be of custom design to match the architectural styles of the Urban Open Space areas or Development Blocks, or be one of the City of Pittsburgh's Standard Shelters or better.
- » Locate at the intersection of Wylie Avenue and Street 1.

#### E. Bollards

- » Bollards shall be used for traffic control and security. Bollards may be lit. Removable and regular bollards shall be located where necessary to control traffic and enhance pedestrian safety. The City of Pittsburgh Standard Bollard or better shall be used.



FIGURE 6.17 Example of security bollards (Landscape Forms).



FIGURE 6.18 Example of bus shelter.



FIGURE 6.19 Example of bus shelter with a Green Roof.



FIGURE 6.20 Example of bench (Landscape Forms).



FIGURE 6.22 Example of City-endorsed bicycle rack for development-wide use.



FIGURE 6.24 Example of recycling container (Landscape Forms).



FIGURE 6.21 Example of dual recycling and trash container (Landscape Forms).



FIGURE 6.23 Example of bench and trash receptacle for development-wide use.



The following images show configurations of site furnishings at typical streets and intersections. These furnishings include bicycle racks, benches, trash /recycling receptacles, and planters. (see PLDP)

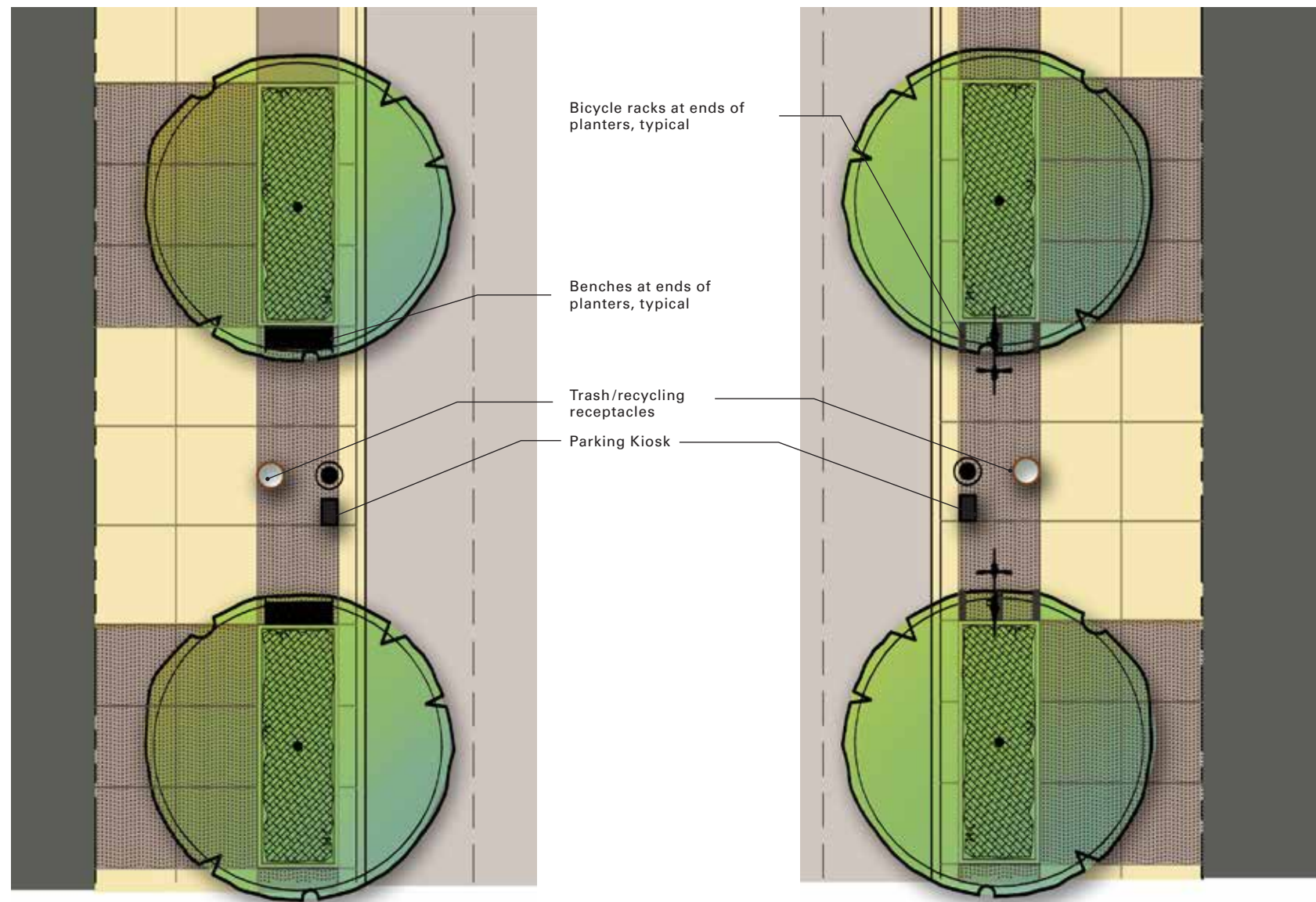

FIGURE 6.25 Example of street furniture configuration showing benches at the ends of planters with a trash/recycling receptacle and light post centered in between.

FIGURE 6.26 Example of street furniture configuration showing bicycle racks at the ends of planters with a trash/recycling receptacle and light post centered in between.

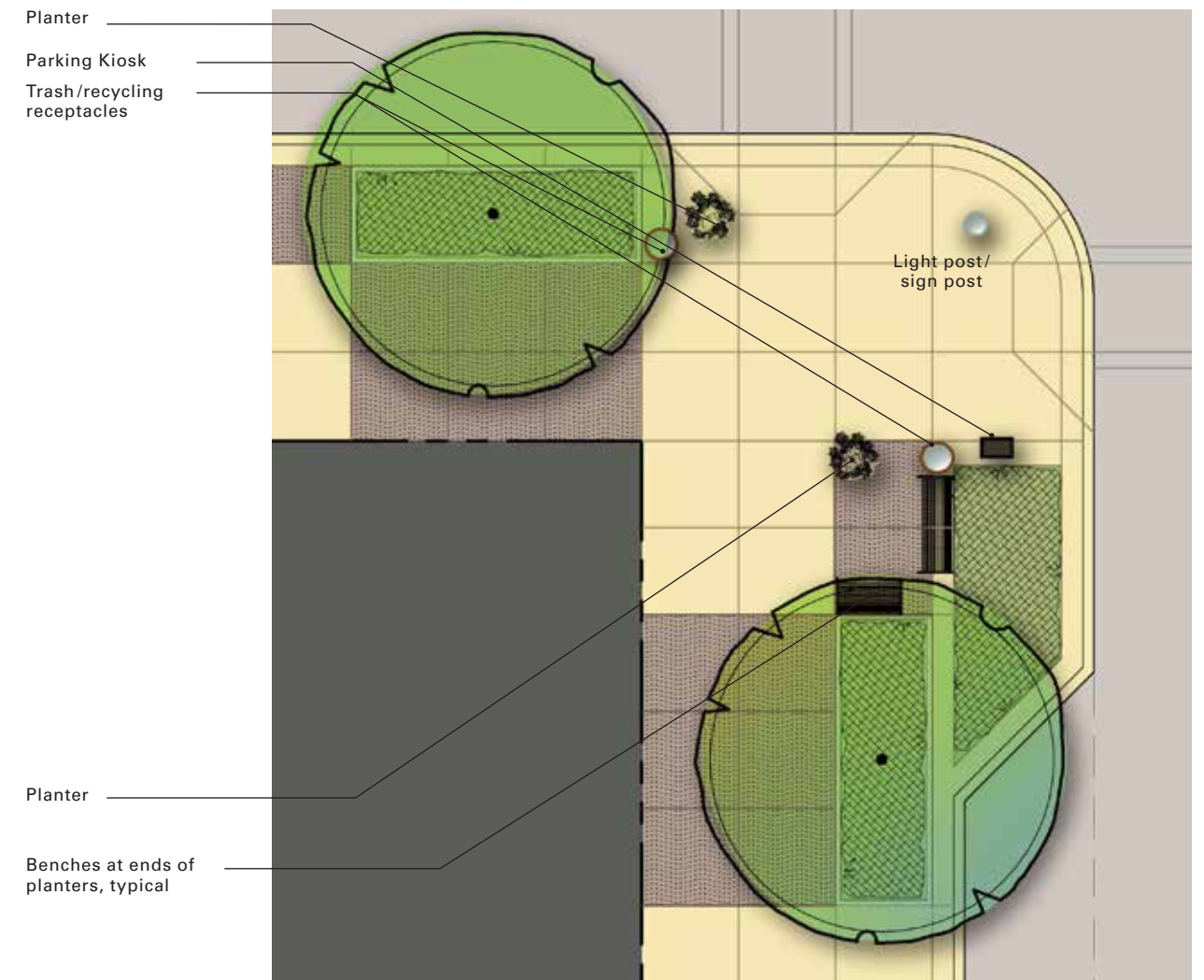

FIGURE 6.27 Example of street furniture configuration at an intersection showing benches and planters creating a small "garden room" and planters and trash/recycling containers along pedestrian paths. Additional plant material is incorporated in the curb bump-outs.



**6.5.2 Furniture – Within Open Spaces and Development Blocks**

The open spaces (including, without limitation, Urban Open Space) and Development Blocks should have the most flexibility in choosing bicycle racks, benches, trash /recycling receptacles, and other site furnishings to convey a unique image or branded character of the various spaces. Furnishings should conform to the overall aesthetic of the open space or development block and complement its architectural character. In all cases, materials must be of high quality, durable materials.

The following images show configurations of site furnishings at typical streets and intersections. These furnishings include bicycle racks, benches, trash /recycling receptacles, and planters.



FIGURE 6.28 Example of moveable table/chairs and umbrellas appropriate for Parks and Open Space and Development Blocks.



FIGURE 6.29 Example of bench (Landscape Forms).



FIGURE 6.30 Example of dual recycling and trash container (Landscape Forms).



FIGURE 6.31 Example of City-endorsed bicycle rack for development-wide use.



FIGURE 6.32 Example of bench and trash receptacle for development-wide use.



FIGURE 6.33 Example of recycling container (Landscape Forms).



# Section 7. Open Space, Art, and Landscape Guidelines

Sec. 7.1 Introduction 77  
Sec. 7.2 Urban Open Space Plan 78  
Sec. 7.3 Art Plans 82  
Sec. 7.4 Plant Palette 83  
Sec. 7.5 Plant Palette Streetscapes 84

## SUSTAINABILITY GOALS



- » Plant canopy trees to provide shade and reduce heat island effect
- » Reduce lawn areas
- » Use native and drought tolerant plant palette to reduce water demand and maintenance
- » Use recessed lawns to aid in stormwater runoff and for passive infiltration
- » Plant edible gardens
- » Capture stormwater runoff
- » Install rain gardens, rain barrels, and rain chains to better manage stormwater
- » Specify a landscape palette that increases habitat for birds, butterflies, and insects
- » Use porous paving in patios and walks to reduce stormwater runoff
- » Use dark sky compliant lighting and energy efficient technologies
- » Specify high efficiency irrigation equipment and climate based controllers. Design irrigation systems that use non-potable water only where required.

## APPLICABLE LEED-ND POINTS (2009 Standards)

- GIB Pre 1 — Certified Green Building
- GIB Credit 1 — Certified Green Buildings
- GIB Credit 4 — Water-Efficient Landscaping
- GIB Credit 8 — Stormwater Management
- GIB Credit 9 — Heat Island Reduction



## Sec. 7.1 Introduction

In this section, open space and landscape guidelines focus on capturing and treating stormwater, providing for green infrastructure and buildings, as well as habitat creation and urban planning strategies.

The purpose of the Open Space and Landscape Guidelines section of the PLDP is to illustrate the intent for Urban Open Space development, discuss general guidelines related to public art, and provide guidance on suggested plant palettes to be used in all landscaping throughout the Lower Hill Redevelopment Site. These guidelines are intended to promote high-quality, sustainable landscape as an integral part of this neighborhood. These landscapes will complement and soften the built environment and lend character to houses, streets, and neighborhoods.



FIGURE 7.1 Perspective showing the character of the Community Open Space.



## Sec. 7.2 Urban Open Space Plan

The Pittsburgh Zoning Code requires that 10% of the development area within an SP District be designated as Urban Open Space. The Urban Open Space requirement is aggregated as shown on the figure to the right, and is therefore not required on a parcel by parcel basis. Semi-public space and other green space is not included in the current calculations although it is envisioned that these types of spaces will be located throughout the overall development.

The 10% Urban Open Space required is being provided in the Urban Open Space currently established for Sub-district 3 and three parcels in Sub-districts 1 and 2 as described in Section 2.6 of this PLDP: (1) The Block H Open Space (which is intended to be part of the CAP Open Space), (2) the Civic Open Space, and (3) the Community Open Space. In addition, CAP Open Space (which is not needed to meet Urban Open Space requirements) is being proposed to bridge over the Crosstown Boulevard connecting the neighborhood to Downtown. See Figure 2.14 to understand the contemplated locations of the Urban Open Space. Figure 7.2 to the right, shows how the CAP Open Space may be developed at the CAP (Block I as shown on Figure 2.14) instead of entirely on Block H. Each of the Cap Open Space, the Civic Open Space, and the Community Open Space will be renamed at a later time, but for the purpose of classification, this document will use these current labels. Each open space has specific guidelines and fulfills specific community needs. Urban Open Spaces will be established in accordance with the schedule set forth in Section 2.6 and may be further enhanced as additional development occurs.

The following three pages identify the anticipated program needs for each of these open spaces with accompanying conceptual designs. Within these open spaces, sustainability goals include using a native plant palette to reduce water demand and maintenance, using permeable paving to reduce stormwater runoff, and specifying canopy trees to provide shade and reduce the heat island effect.



FIGURE 7.2 Open space framework plan showing open spaces and street trees along planted verges.



**7.2.1 CAP Open Space**

The CAP Open Space Plan bridges the gap from the Lower Hill Redevelopment Site to Downtown Pittsburgh by utilizing the existing urban fabric.

A small stand-alone pavilion with either a restaurant and associated outdoor dining or a retail destination with outdoor seating is envisioned adjacent to this open space. Additionally, a tree-lined promenade with bench groupings, garden plantings, and user amenities is a prominent feature. The promenade also acts as an overlook offering dramatic views of Pittsburgh’s skyline.

The corner entry plaza is marked by a pylon, a signage or decorative entry feature, and is an ideal opportunity for an artist intervention. The pylon may also carry signage and information for visitors.

This plan depicts a potential design of the Urban Open Space if the CAP is developed. As set forth in the regulatory sections of this PLDP, there is no requirement to development the CAP Open Space. If the CAP Open Space is not developed, the programing requirements of Block H Open Space will need to be amended.



FIGURE 7.3 Enlarged illustrative plan showing a small adjacent pavilion/restaurant with an outdoor dining terrace, pylon marking the entry plaza, and a tree-lined promenade.



FIGURE 7.4 Perspective showing the layout of the open space.



FIGURE 7.5 Native plantings line walkways and trails.



FIGURE 7.6 Typical open space destination restaurant.



FIGURE 7.7 Promenade lined with shade trees and bench clusters.



FIGURE 7.8 Upper and lower level promenades separated by tree line, plantings, and seating.



**7.2.2 Civic Open Space**

The heart of the development is intended to be the Civic Open Space that serves as a “Major Public Destination Facility Plaza” and provides recreational space for daily leisure use, small events, and larger festivals. The central feature of this space is a gently sloping lawn that culminates in amphitheater seating and a stage. A water feature may also be incorporated at the bottom of the slope to aid in stormwater runoff infiltration.

A small pavilion flanks the open space and may contain various user amenities and open space storage. The side of a proposed building will contain a large video display screen that will have the potential to show hockey games, other sporting events, and concerts, connected to the SP District. The perimeter of the open space is tree-lined and contains a rich palette of native plantings and seating options providing intimate garden room settings.

This space can be used for public festivals and gatherings and will have room for passive play.

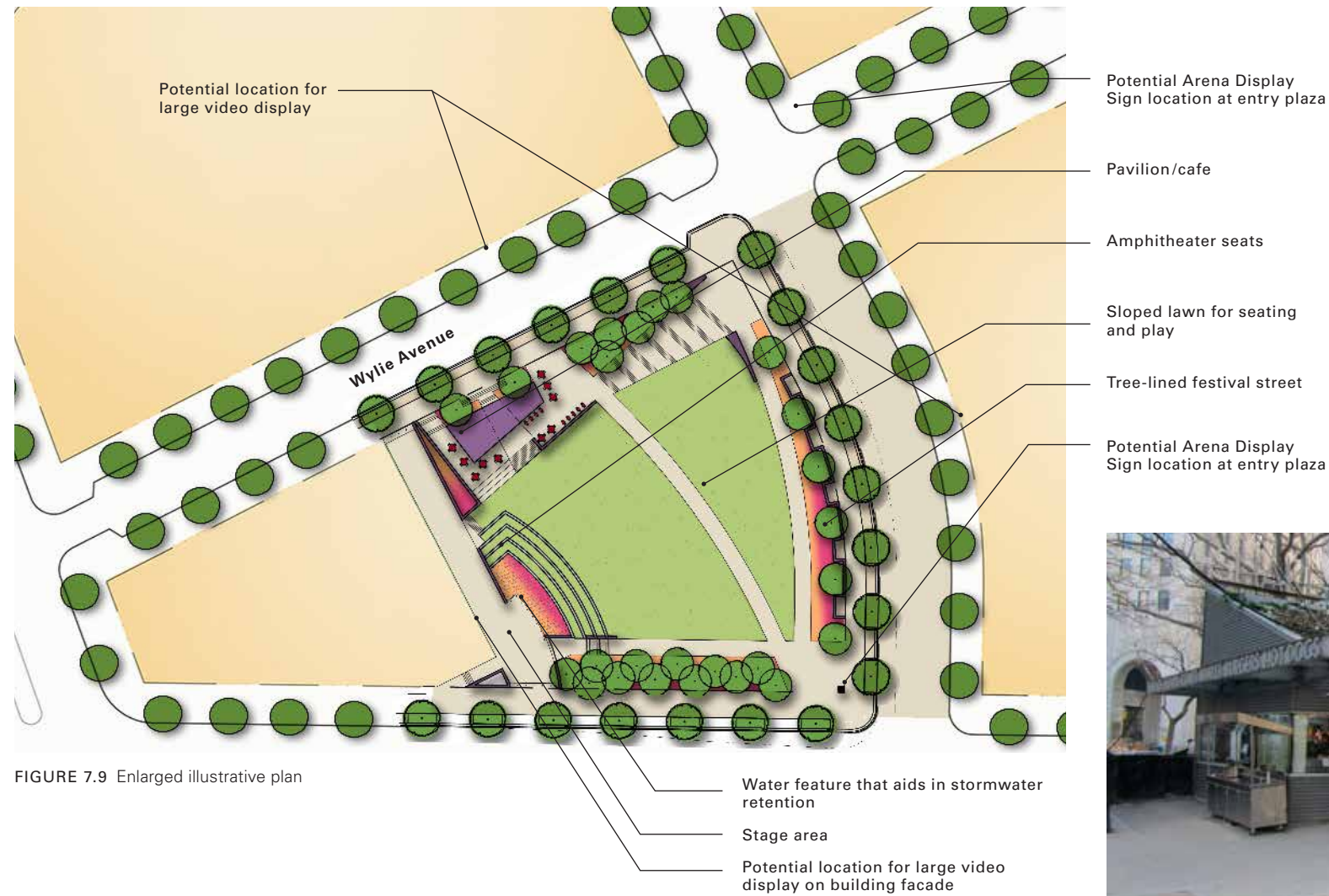

FIGURE 7.9 Enlarged illustrative plan



FIGURE 7.10 Open space pavilion housing user amenities and storage of equipment for daily activities



FIGURE 7.11 Cafe with outdoor seating and heaters allow for year round use



FIGURE 7.12 Amphitheater seating provides space for lunch time story hour or other small scale daily events.



FIGURE 7.13 Image showing symphony event on stage and seating on sloped lawn beyond

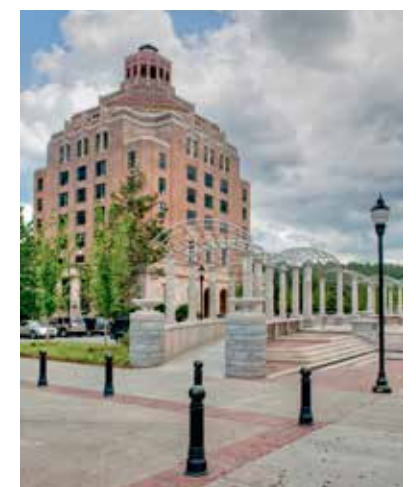

FIGURE 7.14 Bollards and decorative paving bands line a festival street



**7.2.3 Community Open Space**

The Community Open Space is envisioned as a central gathering space. This open space shall include amenities that cater to a wide range of users. By providing creative play zones and courts, a variety of age groups can be accommodated. Community gardens or formal gardens organized by local residents may also be included to clean up edges and provide picturesque addresses for the surrounding residences. Shade structures and seating options shall also be provided at locations serving more than one play or activity area. A diagonal or arcing walk at 5% or less slope is a goal for this open space in order to provide accessibility to all.

In order to create a more sustainable open space, low maintenance and drought tolerant native plants will be proposed. Rain gardens may be created as demonstration gardens for local residents within this open space. The use of porous paving is highly encouraged in open spaces to lessen the impact of stormwater run-off.



FIGURE 7.16 Enlarged illustrative plan.



FIGURE 7.15 An outdoor splash fountain may be considered for the Community Open Space.



FIGURE 7.17 Open basketball courts are suitable in this urban location.



FIGURE 7.18 Art pieces integrated into walkways and site tables allow for individual discovery.



FIGURE 7.19 Open lawn areas for active play.



FIGURE 7.20 Small play areas with seating provide hours of entertainment. Water may also be incorporated into these spaces.



FIGURE 7.21 Pavilions along lawn areas provide relief from the sun.



## Sec. 7.3 Art Plans

Art that is intended to be experienced by the general public (“publicly available art”) is a vital component of any active and vibrant community. Consideration of publically available art in the FLDP process should engage members of the community and artists in order to refine design and placement of art work(s) that reflect the neighborhood’s history, diversity, and culture.

Therefore publically available art shall be an important component in the implementation of this plan as blocks develop. Both the new CONSOL Energy Center and the redevelopment of the Lower Hill Redevelopment Site offer outstanding opportunities for public and private art in open spaces, plazas, building lobbies, and facades.

Art proposals should be commissioned for site specific locations and to celebrate the rich heritage of Pittsburgh, the Hill District, the former Civic Arena, and can include, but is not limited to, themes that honor political, historical, business, sports, and cultural icons. It is intended that the highest and best use of land and built environment opportunities for publically available art match the selection of highest quality contemporary art, artists and modes of contemporary art.

Given the diverse history of the Lower Hill, opportunities exist to commemorate various aspects including the strong African-American legacy, its immigrant history, and center of cultural life. Opportunities for art on the CONSOL Energy Center were described in the New Pittsburgh Arena Public Art Master Plan. The Garden Passage is one such opportunity previously described in that plan.

Publically available art should be integral to the open space network and building fabric. Artists should be engaged early in the site design and building design process to insure that the art will be contextual and appropriate.

Consideration of publically available art shall be integrated into the SP-11 Lower Hill Planned Development District in connection with each FLDP by (i) including the placement of publically available art on-site, incorporating art as part of the exterior building design, and/or locating art within common areas of a building that are made available to the general public, or (ii) contributing towards publically available art in shared off-site spaces within the SP-11 Lower Hill Planned Development District.

### 7.3.1 Interactive Art

Interactive art allows viewers to participate in some way. Viewers are often encouraged to touch, feel, read, or walk through a sequence of experiences. Possible examples for interactive art installations include interactive fountains, descriptive time line panels in railings, paving inserts, etc.

### 7.3.2 Site Specific Art Installations

This type of art installation is created for a specific set of surroundings, unlike conventional art pieces that may be moved from place to place without losing meaning. These pieces draw out the character of their environment.

### 7.3.3 Integrated Art

Artists often collaborate with architects and planners in order to enhance the public domain. In the Lower Hill Redevelopment Site, many opportunities exist to upgrade the palette of site furnishings (benches, lights, railings, etc.) with artist inspired additions. The diagram to the right illustrates possible locations for public art opportunities.



- ART GOALS**
- » Encourage high quality art for permanent locations and sites
  - » Encourage opportunities for high quality temporary art
  - » Encourage art work that engages, promotes, and educates around the sustainable strategies on site

FIGURE 7.22 Art Resource: Add Value Add Art: A public art resource guide for developers. Prepared by the Office of Public Art for the Urban Redevelopment Authority, 2010. The report discusses the process for setting budgets, selecting artists, maintenance, and developing art plans.

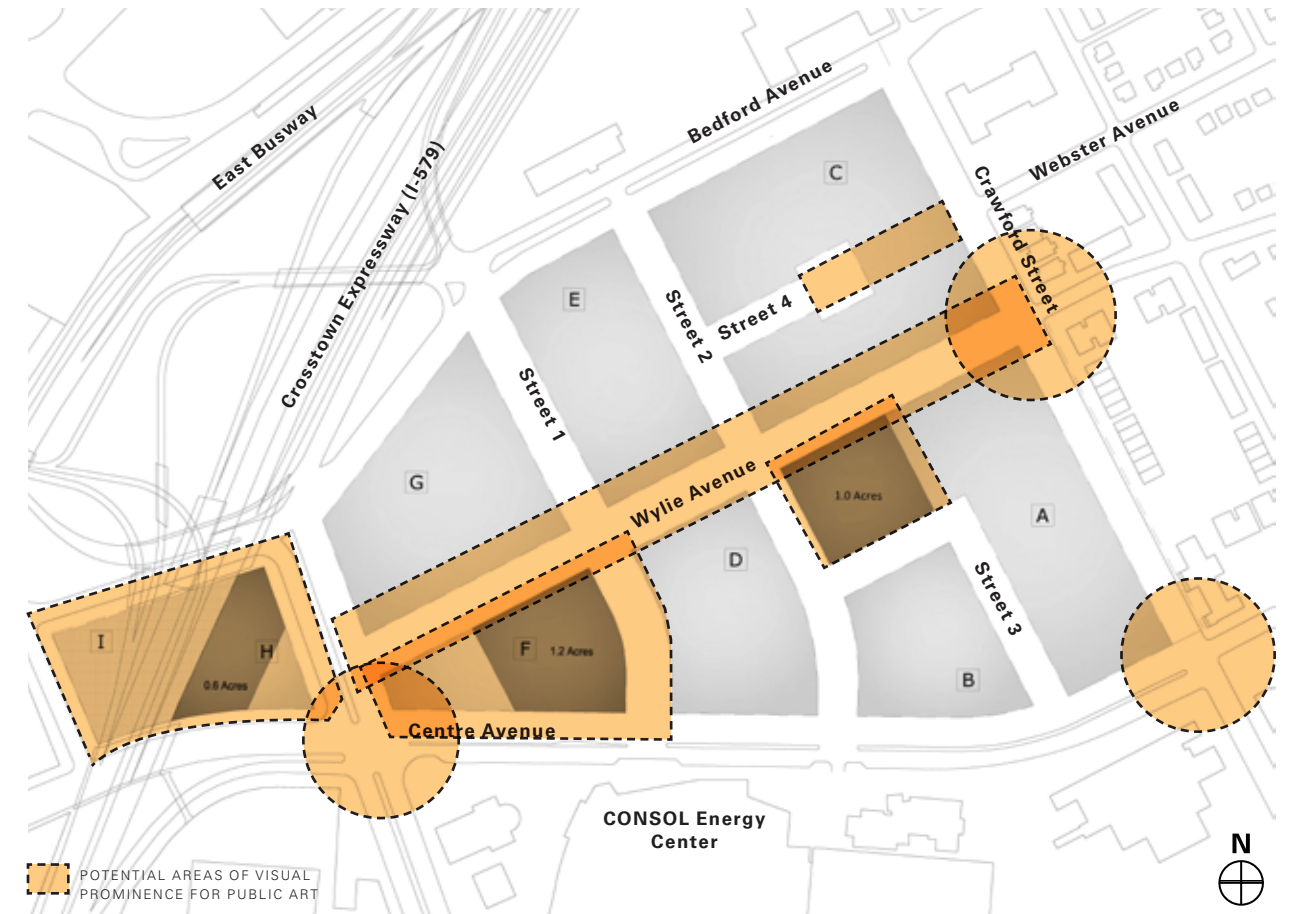

FIGURE 7.23 Plan showing potential locations of art installations. Art opportunities are not limited to single installations but may include custom paving, railings, seating, and water features.



FIGURE 7.24 Example of public art that commemorates history and legacy (The Kunta Kinte-Alex Haley Memorial, Annapolis, MD)



FIGURE 7.25 Example of public interactive art. The discs transmit whispers from one to the other allowing pairs of users to play.



FIGURE 7.26 Example of environmental art. The water course is etched into the paving providing information of the surrounding region and pedestrian interest.



FIGURE 7.27 Example of artist's scrolling text in paving



## Sec. 7.4 Plant Palette

### 7.4.1 Native Plants

Indigenous plants evolved with the local climate and the soil; therefore, they are perfectly suited to the region. There are many advantages to using local plants besides their ability to thrive. They are often low maintenance and thrive without the addition of fertilizers or pesticides, and they provide food and shelter for native wildlife.

The following list consists of the “best of the best” plant materials for use in the Lower Hill Site Redevelopment, and should serve as both a guide and a starting point for plant selection. The plant list focuses exclusively on native plant material suitable to the region. The Urban Forest Master Plan also provides guidance on this subject.

Many factors were considered in selecting the short list of plant materials including form and size, tolerance to urban conditions such as soil compaction, salt and brine spray, availability and hardiness, wildlife value, and beauty and seasonal color. The ideal plant for the proposed dense urban setting would be readily available and grow in almost any microclimate. It should be non-invasive, long lived, and provide forage and habitat for many songbirds and butterflies. This plant would also resist any disease or environmental stress and provide a vivid display of changing color throughout all seasons. Although this “ideal” plant is a fabrication, it is useful to underscore that plants making the following list needed to perform well in multiple categories versus being a standout in one particular category and showing poorly in several others. For additional information on using native plant material, reference the following websites:

- » [www.plantnative.org/nd\\_patova.htm](http://www.plantnative.org/nd_patova.htm)
- » [www.earthtonesnatives.com](http://www.earthtonesnatives.com)
- » [www.pawildflower.org](http://www.pawildflower.org)
- » [www.dcnr.state.pa.us/forestry/LandscapingBrochure.pdf](http://www.dcnr.state.pa.us/forestry/LandscapingBrochure.pdf)

### 7.4.2 Ornamental Plants

In some cases, ornamental plants (non native plants that are not invasive but do well in the climate) are acceptable. These plants will typically only be used at formal garden areas in limited quantities.

### 7.4.3 Green Roof Plants

If green roofs are used on development blocks, plant materials should be selected from non-invasive materials recommended by the manufacturer to insure compatibility with soil depths. As another part of the urban forest, Green Roof planting is either intensive or extensive. Extensive Green Roof planting typically relies on a mixture of low lying plants such as sedums.

Intensive plantings require more soil and structure for support, but are able to provide habitat for birds, butterflies, and insects. Intensive plantings may use the perennials, groundcovers, and grasses on this list as well as the page that follows.

SCIENTIFIC NAME	COMMON NAME
<b>CANOPY TREES</b>	
<i>Acer rubrum</i>	Red Maple
<i>Acer saccharum</i>	Sugar Maple
<i>Carya ovata</i>	Shagbark Hickory
<i>Fagus grandifolia</i>	American Beech
<i>Larix laricina</i>	American Larch
<i>Nyssa sylvatica</i>	Black Tupelo
<i>Prunus serotina</i>	Black Cherry
<i>Quercus alba</i>	White Oak
<i>Quercus rubra</i>	Red Oak
<i>Tilia americana</i>	Basswood
<i>Ulmus americana</i> ‘Princeton’	Princeton American Elm
<b>UNDERSTORY TREES</b>	
<i>Amelanchier canadensis</i>	Shadblow Serviceberry
<i>Betula lenta</i>	Black Birch
<i>Betula nigra</i>	River Birch
<i>Cornus florida</i>	Flowering Dogwood
<i>Hamamelis virginiana</i>	Witchhazel
<i>Malus coronaria</i>	Sweet Crabapple
<i>Ostrya virginiana</i>	American Hophornbeam
<i>Pyrus malus</i>	Apple (domestic)
<b>DECIDUOUS SHRUBS</b>	
<i>Aronia melanocarpa</i>	Black Chokeberry
<i>Cornus racemosa</i>	Grey Dogwood
<i>Cornus sericea</i>	Red-osier Dogwood
<i>Ilex verticillata</i>	Winterberry (1 male:3 female)
<i>Rosa virginiana</i>	Virginia Rose
<i>Salix g. ‘Melanostachys’</i>	Black Pussy Willow
<i>Sambucus canadensis</i>	American Elder
<i>Spiraea alba</i>	Meadowsweet
<i>Viburnum lentago</i>	Nannyberry
<b>EVERGREEN SHRUBS</b>	
<i>Gaultheria hispidula</i>	Creeping Snowberry
<i>Juniperus communis</i>	Common Juniper
<i>Kalmia angustifolia</i>	Sheep Laurel
<i>Ledum groenlandicum</i>	Labrador Tea
<i>Taxus canadensis</i>	Canada Yew

SCIENTIFIC NAME	COMMON NAME
<b>GRASSES</b>	
<i>Andropogon gerardii</i>	Big Bluestem
<i>Eragrostis spectabilis</i>	Purple Lovegrass
<i>Panicum virgatum</i>	Switch Grass
<i>Schizachyrium scoparium</i>	Little Bluestem
<i>Sorghastrum nutans</i>	Yellow Indian Grass
<i>Spartina pectinata</i>	Prairie Cordgrass
<i>Tridens flavus</i>	Tall Redtop
<b>GROUNDCOVER</b>	
<i>Arctostaphylos uva-ursi</i> (6"-12")	Bearberry
<i>Asarum canadense</i> (6"-12") (12"-18")	Wild Ginger
<i>Cornus canadensis</i> (3"-6")	Bunchberry
<i>Dennstaedtia punctiloba</i> (12"-18")	Hay-scented Fern
<i>Dryopteris marginalis</i>	Leatherwood Fern
<i>Gaultheria hispidula</i>	Creeping Snowberry
<i>Juniperus horizontalis</i>	Bar Harbor Juniper
<i>Pachysandra procumbens</i> (6")	Allegheny Spurge
<i>Phlox divaricata</i> (8"-18")	Canadian Phox
<i>Sedum ternatum</i> ‘Larinem Park’	Stoncrop
<i>Tiarella cordifolia</i> (6"-12")	Foamflower
<i>Trifolium repens</i>	White Clover
<b>PERENNIALS</b>	
<i>Anemone canadensis</i>	Roundleaf Thimbleweed
<i>Anemone quinquefolia</i>	Wood Anemone
<i>Aquilegia canadensis</i>	Wild Columbine
<i>Asclepias syriaca</i>	Common Milkweed
<i>Asclepias tuberosa</i>	Butterfly Weed
<i>Aster novae-angliae</i>	New England Aster
<i>Caulophyllum thalictroides</i>	Blue Cohosh
<i>Cypripedium reginae</i>	Showy Lady’s Slipper
<i>Eupatorium purpurea</i>	Joe Pye Weed
<i>Heliopsis helianthoides</i>	Sweet Ox-eye
<i>Iris versicolor</i>	Blue Flag Iris
<i>Rudbeckia hirta</i>	Sweet Black-Eyed Susan
<i>Penstemon digitalis</i>	Foxglove Beardtongue
<i>Verbena hastata</i>	Blue Vervain
<i>Viola labradorica</i>	Labrador Violet



FIGURE 7.28 Photo of Blue Flag Iris flower



FIGURE 7.29 Photo of Red-osier dogwood stems



FIGURE 7.30 Photo of Switch grass along side New England asters



## Sec. 7.5 Plant Palette Streetscapes

### 7.5.1 Streetscape and the Urban Forest

An urban forest is the collection of trees that grow within a city. An urban forest provides many ecological as well as economic benefits to its citizens including moderating the local climate, slowing stormwater, and shading homes and businesses to reduce energy consumption. Street trees and streetscape planting are a large component of Pittsburgh's urban forest and as such will be the hardiest materials on our urban plant list. These plants are low maintenance, salt and pollution tolerant, and offer a variety of forms, textures, and colors providing interest for pedestrian traffic. Often a variety of tree species will be planted along a street in order to strengthen the urban forest of Pittsburgh.

The Understory Trees: Group A category applies to most plantings under utility lines. This is necessary to consider because most lines are less than 25 feet above ground. Where possible, trees should be offset so that they are not directly under the wires.

The Understory Trees: Group B applies only to utility plantings where the bottom wire is over 25 feet above the ground. Where possible, these trees should also be offset so as not directly under the wires.

The shrubs, groundcovers, and perennials on this streetscape list are also known to be extremely tolerant of road salt and wind.

For additional information on protecting Pittsburgh's urban forest, contact: [www.treepittsburgh.org](http://www.treepittsburgh.org)

SCIENTIFIC NAME	COMMON NAME
<b>UNDERSTORY TREES: GROUP A</b>	
<i>Acer ginnala</i>	Amur Maple
<i>Acer tataricum</i>	Tatarian Maple
<i>Crateagus laevigata</i> 'Superba'	Crimson Cloud Hawthorn
<i>Magnolia stellata</i>	Star Magnolia
<i>Malus floribunda</i>	Japanese Flowering Crabapple
<b>UNDERSTORY TREES: GROUP B</b>	
<i>Acer campestre</i>	Hedge Maple
<i>Acer griseum</i>	Paperbark Maple
<i>Amelanchier laevis</i> 'Majestic'	Apple Serviceberry
<i>Carpinus caroliniana</i>	American Hornbeam
<i>Cercic candensis</i>	Eastern Redbud
<i>Koelreuteria paniculata</i>	Goldenrain Tree
<i>Prunus serrulata</i>	Flowering Cherry
<b>SHRUBS AND GROUNDCOVERS</b>	
<i>Arctostaphylos uva-ursi</i>	Bearberry
<i>Aronia</i> spp.	Chokeberry
<i>Cornus racemosa</i>	Gray Dogwood
<i>Cotoneaster divaricatus</i>	Spreading Cotoneaster
<i>Cotoneaster horizontalis</i>	Rock Cotoneaster
<i>Hibiscus syriacus</i>	Rose-of-Sharon
<i>Hydrangea</i> spp.	Hydrangea
<i>Hypericum</i> spp.	St. Johnswort
<i>Ilex verticillata</i>	Winterberry
<i>Myrica pensylvanica</i>	Bayberry
<i>Philadelphus</i> spp.	Mockorange
<i>Potentilla fruticosa</i>	Potentilla
<i>Ribes alpinum</i>	Alpine Currant
<i>Rosa rugosa</i>	Saltspray Rose
<i>Symphoricarpos</i> spp.	Snowberry or Coralberry
<i>Syringa</i> spp.	Lilac
<i>Vaccinium</i> spp.	Blueberry/Cranberry
<i>Viburnum dentatum</i>	Arrowwood

SCIENTIFIC NAME	COMMON NAME
<b>PERENNIALS</b>	
<i>Artemisia</i> x 'Powis Castle'	'Powis Castle' Artemisia
<i>Artemisia schmidtiana</i>	'Silver Mound' Silver Mound Artemisia
<i>Calamagrostis acutiflora</i>	'Karl Foerster' 'Karl Foerster' Reed Grass
<i>Dianthus gratianopolitanus</i>	Cheddar Pink
<i>Festuca ovina glauca</i>	Blue Fescue Grass
<i>Helleborus orientalis</i>	Lenten Rose
<i>Hemerocallis</i> spp.	Daylily
<i>Hosta</i> spp.	Hosta
<i>Iberis sempervirens</i>	Candytuft
<i>Limonium latifolium</i>	Sea Lavender
<i>Liriope spicata</i>	Lilyturf
<i>Pennisetum alopecuroides</i>	Fountain Grass
<i>Sedum spectabile</i> 'Autumn Joy'	Sedum 'Autumn Joy'
<i>Schizachyrium scoparium</i>	Little Bluestem
<i>Yucca filamentosa</i>	Adam's-needle Yucca



FIGURE 7.32 Photo of Eastern Redbud flower



FIGURE 7.33 Photo of Bayberry shrub



FIGURE 7.31 Photo showing thriving streetscape plantings in East Liberty



FIGURE 7.34 Photo showing intensive Green Roof planting featuring native grasses and perennials.



# Section 8. Systems and Networks Integration

Sec. 8.1 Introduction 86

Sec. 8.2 Energy District and Private Utility Systems Integration 87

Sec. 8.3 Transit and Bicycle Network Connections 88

Sec. 8.4 Pittsburgh 2030 District Initiative 89

Sec. 8.5 Transportation Demand Management 90

## SUSTAINABILITY GOALS



- » Improve stormwater management by including sub-surface infiltration and/or rainwater harvesting without allowing any offsite discharge
- » Implement localized or centralized techniques, including Green Roofs, porous pavement, amended soils, and infiltration practices
- » Implement sustainable street techniques on public streetscapes, including stormwater planters and porous parking strips with sub-surface recharge beds
- » Implemented regional stormwater facilities at the public parks to manage stormwater runoff from the public streets
- » Reuse rainwater for irrigation or ornamental water features or other non-potable water uses, such as toilet flushing or cooling tower makeup
- » Provide bicycle parking that is incorporated throughout the development
- » Implement shared parking strategies, vehicle sharing programs, and shuttle services

## APPLICABLE LEED-ND POINTS (2009 Standards)

- SLL Credit 3 — Locations with Reduced Automobile Dependence
- SLL Credit 4 — Bicycle Network and Storage
- NPD Credit 5 — Reduced Parking Footprint
- NPD Credit 7 — Transit Facilities
- NPD Credit 8 — Transportation Demand Management
- GIB Credit 8 — Stormwater Management
- GIB Credit 11 — On-Site Renewable Energy Sources
- GIB Credit 12 — District Heating and Cooling
- GIB Credit 13 — Infrastructure Energy Efficiency
- GIB Credit 14 — Wastewater Management
- GIB Credit 15 — Recycled Content in Infrastructure
- GIB Credit 16 — Solid Waste Management Infrastructure



## Sec. 8.1 Introduction

The Lower Hill Redevelopment Site, though it may be developed by various entities, should have a cohesive strategy of integration for several key systems and networks. These include some concepts that were previously discussed such as Stormwater Systems Integration (discussed in Section 2.3) and Multi-User Parking strategies (discussed in 2.9). In addition, the following are also key systems and networks and are discussed further in this section:

- » Energy systems integration and utility systems integration
- » Transit strategies
- » Pittsburgh 2030
- » Transportation demand management

Adopting a cohesive strategy for these elements will yield the maximum benefit for future occupants, developers, and the City. These systems tend to gain in efficiency as a greater land area is considered, therefore it is recommended that developers consider a comprehensive approach to addressing these issues.



FIGURE 8.1 Energy Systems Integration and Utility Systems Integration



FIGURE 8.3 Transit Strategies



FIGURE 8.2 Integration with the 2030 District initiative



FIGURE 8.4 Transportation Demand Management- consider measures to reduce vehicle trips to and from the site.



## Sec. 8.2 Energy District and Private Utility Systems Integration

The efficient use of energy for lighting, power, and heating and cooling is a major component of sustainable design, both for individual buildings and for multi-use developments like the Lower Hill Redevelopment Site. Sustainability standards are available for individual buildings, such as LEED certifications, and for development sites, such as LEED-ND. These current standards from the U.S. Green Building Council are baseline guidelines for the project.

The goal, however, is to raise the bar by employing leading edge technology and practices that are financially feasible and physically implementable. Examples of advanced technology being considered include co-generation, combined heat and power, bio-mass, geo-exchange, geo-thermal and solar. These can be utilized at the building scale and at the broader site development scale. Performance data gathering and reporting would be conducted in support and advancement of the Pittsburgh 2030 District initiative.

At the site development scale, other options are available, such as the creation of a central co-generation plant that would supply heating and cooling to individual buildings, thus eliminating the need for large mechanical rooms and equipment in each building. Excess electric energy from the cogeneration plant could be sold back to the regional electric grid.

The financial feasibility of a central plant and central energy district will be dependent upon the mix of uses, the phasing of the development, the location of the central plant, the availability of off-premise loads and the willingness of third-party vendors to build and operate the central plant and distribution network. In order to keep the energy district option open, provision should be made up front in the development of the street infrastructure to provide utility pathways for future installation of below ground pipes to carry chilled and hot water to individual blocks and buildings.

STAND ALONE BUILDING SYSTEMS



FIGURE 8.5 Energy Diagram Dependant on Individual Building Systems

DISTRICT ENERGY SYSTEM

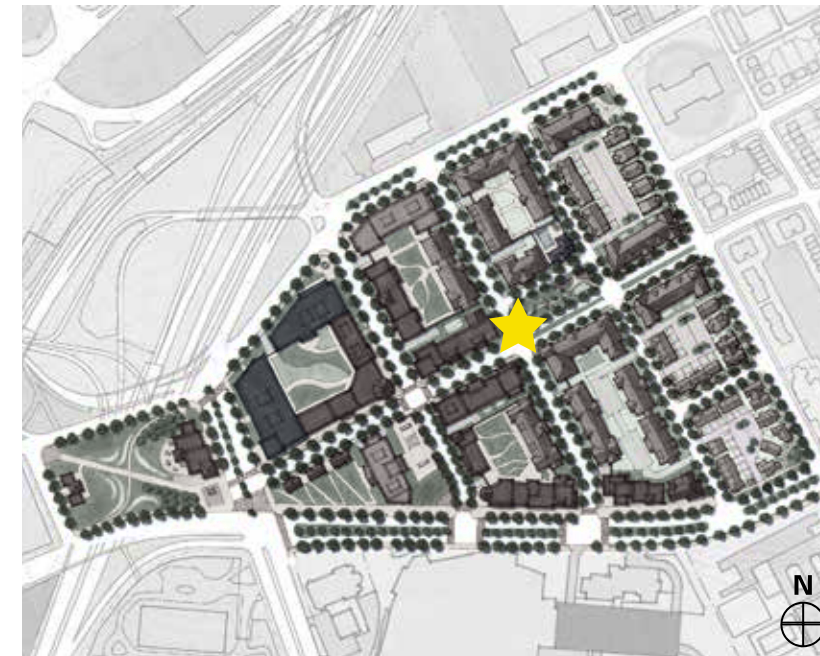

FIGURE 8.6 Energy Diagram Dependant on a Central System



## Sec. 8.3 Transit and Bicycle Network Connections

Offering alternate modes of transportation (other than by single user vehicles) is critical to maximizing the walkability of the Site. The site is ideally located along major bus routes and in walking distance from many Downtown amenities. In addition, an extensive system of bikeways, riverfront trails, and light rail are accessible within a ten minute walk. The diagrams below demonstrate the proximity to these alternate modes of transport.

In addition to the currently available public transit network, the Port Authority is presently engaged in a study of a Bus Rapid Transit (BRT) system to connect the Central Business District to Oakland. If implemented, the BRT service will provide an enhanced public transit connection opportunity from the Lower Hill Site Redevelopment to Oakland, the third-highest trip generator in the Commonwealth of Pennsylvania (behind only Philadelphia and Downtown Pittsburgh). This would significantly improve transit connections to the medical, university, cultural, and business community in Oakland.

In addition, the MOVE PGH study intends to recommend the creation of a transit district in Uptown, which could significantly increase premium transit service in the Centre Avenue corridor, to be implemented by others.

It should also be noted that there is presently public transit service between the Pittsburgh International Airport and both Downtown and Oakland. The possibility of additional service stop(s) in the Lower Hill Site Redevelopment could be investigated with the Port Authority.

Bicycle network connectivity throughout the City is the subject of the ongoing MOVEPGH study being performed under the direction of the City of Pittsburgh Department of City Planning. As part of the outcome of this study, additional bicycle facilities, and connections are anticipated, which will enhance bicycle connectivity to the Lower Hill Site Redevelopment and throughout the City. The exact details and locations of these bicycle amenities have not yet been determined. Figures 8.8 and 8.9 to the right show contemplated bus routes and stops on the site.

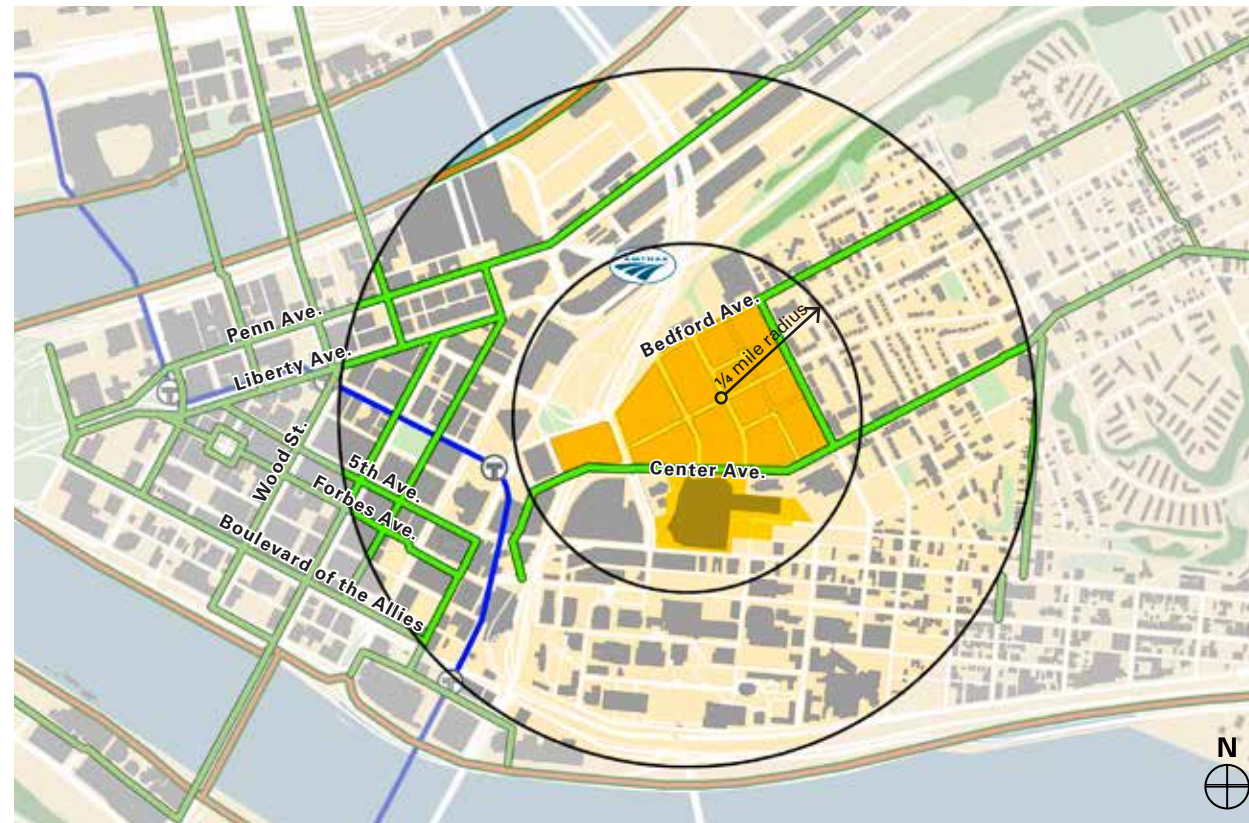

FIGURE 8.7 Bikeway and Trail Systems

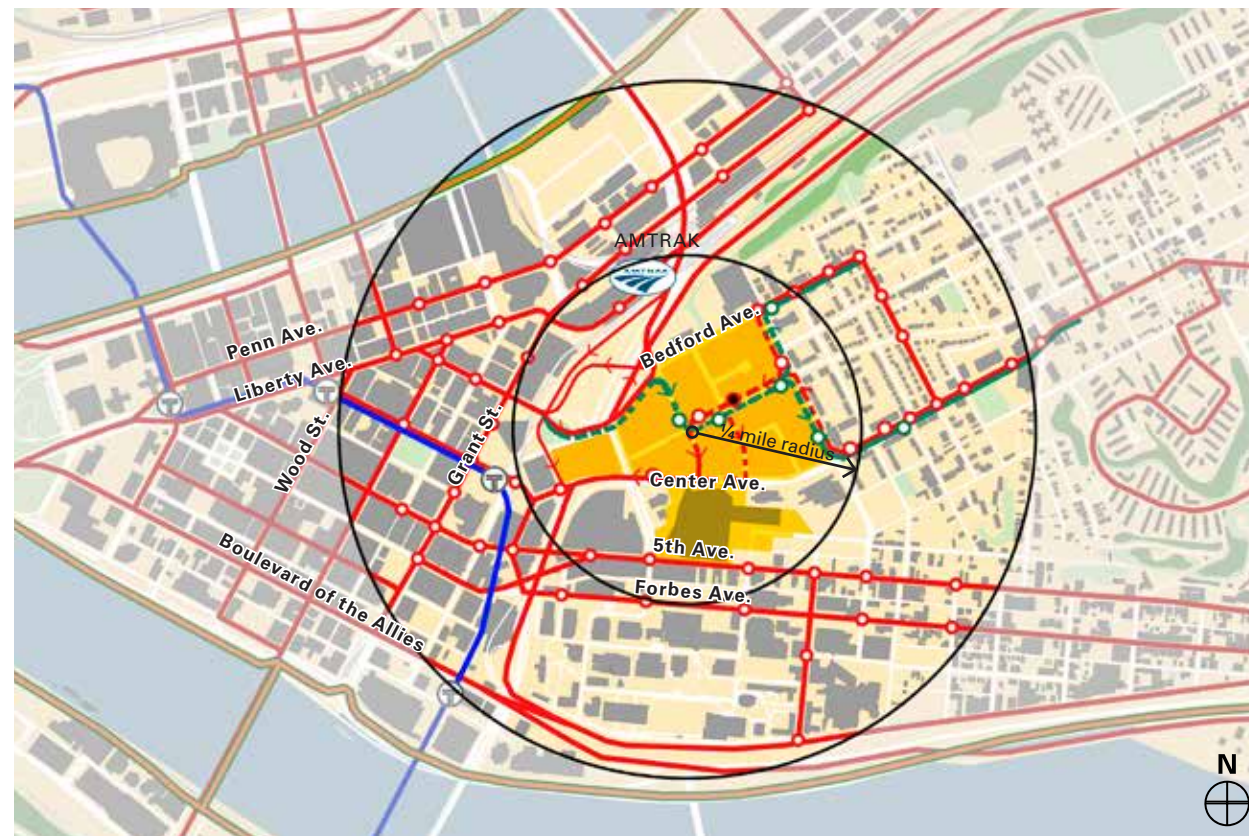

FIGURE 8.8 Transit Systems

- PROPOSED BUS ROUTE INBOUND
- PROPOSED BUS ROUTE OUTBOUND
- NOTE: DURING STREET CLOSURES ON STREET 1, STREET 2 WILL BE USED AS THE ALTERNATE ROUTE
- BUS ROUTE
- LIGHT RAIL ROUTE

- ON STREET BIKE ROUTE (BIKE PGH!)
- TRAILS

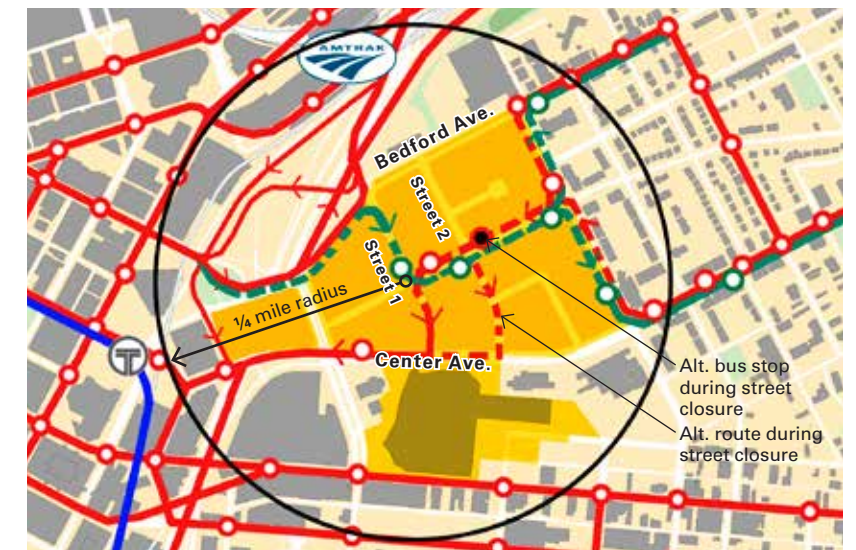

FIGURE 8.9 Detail plan of projected bus routes through the site

- PROPOSED BUS ROUTE INBOUND
- PROPOSED BUS ROUTE OUTBOUND
- NOTE: DURING STREET CLOSURES ON STREET 1, STREET 2 WILL BE USED AS THE ALTERNATE ROUTE INBOUND TOWARDS DOWNTOWN
- ALTERNATE BUS STOP WHEN STREET 1 IS CLOSED



## Sec. 8.4 Pittsburgh 2030 District Initiative



As part of the previously stated sustainability goals, it is envisioned that development on this site will also contribute to the Pittsburgh 2030 District. The Pittsburgh 2030 District is a collaborative effort by owners of certain downtown buildings to establish a high performance building district. The intent is to reduce negative environmental impacts in the central business district, while increasing competitiveness within the business environment and owner's return in investment. This initiative sets standards for both existing and new buildings in the district. The goals set forth for within the PLDP, including developing the site in accordance with LEED-ND compliance, are consistent with the 2030 District and suggest that development on this site will help to advance the 2030 District initiative.

For additional information, please see: <http://www.2030districts.org>

The following information on the goals of the district are provided courtesy: <http://www.2030districts.org>

### EXISTING BUILDINGS AND INFRASTRUCTURE OPERATIONS:

**Energy Use:** A minimum 10% reduction below the national average by 2015, with incremental targets reaching a 50% reduction by 2030.

**Water Use:** A minimum 10% reduction below the District average by 2015, with incremental targets reaching a 50% reduction by 2030.

**Transportation CO2 Emissions:** A minimum 10% reduction below the District average by 2015, with incremental targets reaching a 50% reduction by 2030.

**Indoor Air Quality:** To be determined by District Partners

### NEW BUILDINGS, MAJOR RENOVATIONS AND NEW INFRASTRUCTURE

**Energy Use:** An immediate 60% reduction below the national average, with incremental targets reaching carbon neutral by 2030.

**Water Use:** An immediate 50% reduction below the District average.

**Transportation CO2 Emissions:** An immediate 50% reduction below the District average.

**Indoor Air Quality :** To be determined by District Partners



FIGURE 8.10 Graphic of existing and future partners within the 2030 District (courtesy of [www.2030districts.org](http://www.2030districts.org))

### BASELINES

In order to measure the Pittsburgh 2030 District's success in reaching its 50% reduction goals, baselines must first be determined for each reduction category. The reduction goals above are measured against a national baseline for energy and against District baselines for water and transportation. As properties commit to and work towards 2030 goals, the individual baselines against which they are measured become very important. The Pittsburgh 2030 District Energy Baseline document offers details about the District's energy baseline for individual buildings – as well as the implications for aggregate District energy use and reductions.

### BUILDING-SPECIFIC ENERGY BASELINES

In accordance with The 2030 Challenge, the energy performance baseline for 2030 Districts nationwide is determined individually for each building using national median building energy consumption values based on 2003 Commercial Building Energy Consumption Survey (CBECS) data. Produced by the Energy Information Association (EIA), a sub-agency of the U.S. Department of Energy, CBECS is a national survey of a representative set of commercial buildings across the U.S. that includes their energy costs, consumption, and energy-specific characteristics. CBECS data has been analyzed to determine national and regional medians of whole building site energy use intensity (EUI), which is a building's annual energy use divided by its gross square footage (measured in kBtu/ft<sup>2</sup>/yr). Generally, a lower EUI indicates better building energy performance, but EUIs vary widely by building use. The Pittsburgh 2030 District has compiled estimated national median energy baselines for building use types in Downtown Pittsburgh, which are available in full Pittsburgh 2030 District Energy Baseline.



## Sec. 8.5 Transportation Demand Management

Developers and tenants at the site may take certain measures to reduce trips to and from the site to meet the 20% reduction goal of LEED-ND. These measures could include:

- » **Parking cash out:** Commuters or residents who are eligible for a free parking space are also offered the cash equivalent when they use alternative transportation modes.
- » **Flextime:** The employer allows employees to work nontraditional hours to avoid driving during peak commute times.
- » **Ride sharing:** Commuters travel together in carpools or vanpools.
- » **Ride matching:** An organized system matches residents or workers to facilitate ride sharing. For example, rosters with contact information for those interested in ride sharing are established and regularly updated.
- » **Pedestrian and bicycle promotion:** A project can support and promote non-motorized transportation by providing preferred bicycle parking, showers, or reimbursement for employees' cycling or pedestrian mileage.
- » **Guaranteed ride home:** The employer offers an occasional subsidized ride — via taxi, company vehicle, or rental car — to carpoolers, cyclists, ride-share commuters, or transit users who miss a rider after working late, are commuting to an irregular location, or must tend to an emergency at home. Guaranteed ride home programs address a common objection to the use of alternative modes of transportation.
- » **Car-free programs:** Schools, campuses, office-buildings, civic facilities, or other large nonresidential facilities can establish policies that discourage or prohibit unnecessary driving.
- » **Transit passes:** Subsidized transit passes
- » **Vehicle sharing:** Vehicle sharing of a car rental in which users rent cars for a short period, often by the hour. It enables people to avoid the high fixed costs of car ownership while still having access to a car when needed. Zipcar® stations (a program already introduced in Pittsburgh) could be established within the Lower Hill Site Redevelopment.
- » **Bicycle sharing:** Bicycle sharing is a program where one pays for a subscription or by the hour to rent a bicycle for short, in-town trips. Rental stations would be located at key public destinations to allow for visibility and easy access. Bicycle sharing could serve to reduce vehicle use, and would be available at all hours of the day. This should be part of a city-wide program to provide for maximum impact. Locations for these facilities have not yet been determined, and will be part of the Move-PGH process.



FIGURE 8.12 A Bicycle Sharing Program would be a network of rental stations allowing users to pick up a bicycle in one location and drop it off in another station nearby their final destination. One such station was recently installed at Bakery Square with another located at Carnegie Mellon University.



FIGURE 8.11 Vehicle Sharing stations should be easily accessible and can occur on-street (in a parallel parking space), in parking lots or in parking garages.



FIGURE 8.13 Ride Sharing Programs could be further promoted by offering preferential parking locations.



FIGURE 8.14 Car-Free Programs promote use of other modes of transit. BikePGH currently encourages the region's residents to reduce the number of single occupant car trips through Car Free Fridays which offer events and rewards for participants.



# Section 9. Transit and Pedestrian Improvements

Sec. 9.1 Recommended Perimeter Street Improvements 92

Sec. 9.2 Intersection Pedestrian Amenities 97

Sec. 9.3 Traffic Signalization 98

## SUSTAINABILITY GOALS



- » Promote a walkable neighborhood by providing a safe, appealing and comfortable street environment, including continuous sidewalks, on-street parking or a planting strip between the sidewalk & the street as a buffer zone to enhance the sidewalk's walkability and streetscapes amenities, such as benches, street lights, bicycle racks
- » Reduce urban heat island effects by providing street trees
- » Implement sustainable street landscapes where grading permits to contribute to the reduction of stormwater runoff

## APPLICABLE LEED-ND POINTS (2009 Standards)

- NPD Pre 1 — Walkable Streets
- NPD Credit 1 — Walkable Streets: Design for Safe Pedestrian and Bicycle Travel
- NPD Credit 7 — Transit Facilities
- NPD Credit 14 — Tree-lined and Shaded Streets



# Sec. 9.1 Recommended Perimeter Street Improvements

This section is intended to provide additional recommendations for improvements to the existing perimeter streets in order to improve pedestrian access and connectivity to and through the site. Required improvements to Bedford Avenue, Crawford Street, Centre Avenue, and Washington Place within the SP District are described in Section 3. This section provides guidance for recommended improvements on the opposite side of these streets in order to enhance the pedestrian realm.

The pedestrian connection between Downtown and the Lower Hill Redevelopment Site is vital to create a cohesive network and mend the divide that resulted from the construction of highways between Downtown and the Hill District. The recommendations for off-site improvements are intended to ensure consistency between the design of perimeter streets and the streets on site, and address public safety improvements immediately adjacent to the site to improve pedestrian connectivity.

In the depictions that follow, certain improvements are labeled "required" which signifies that such improvements are mandatory. The remaining improvements are labeled "recommended" and are provided in this section for the convenience of the reader, but are not mandatory regulations. The recommended improvements are strongly encouraged and should be pursued as funding becomes available and if approved by the Department of Public Works. The pages that follow describe both recommended and required improvements to Bedford Avenue; Crawford Avenue; Centre Avenue, Washington Place, and Pride Street.

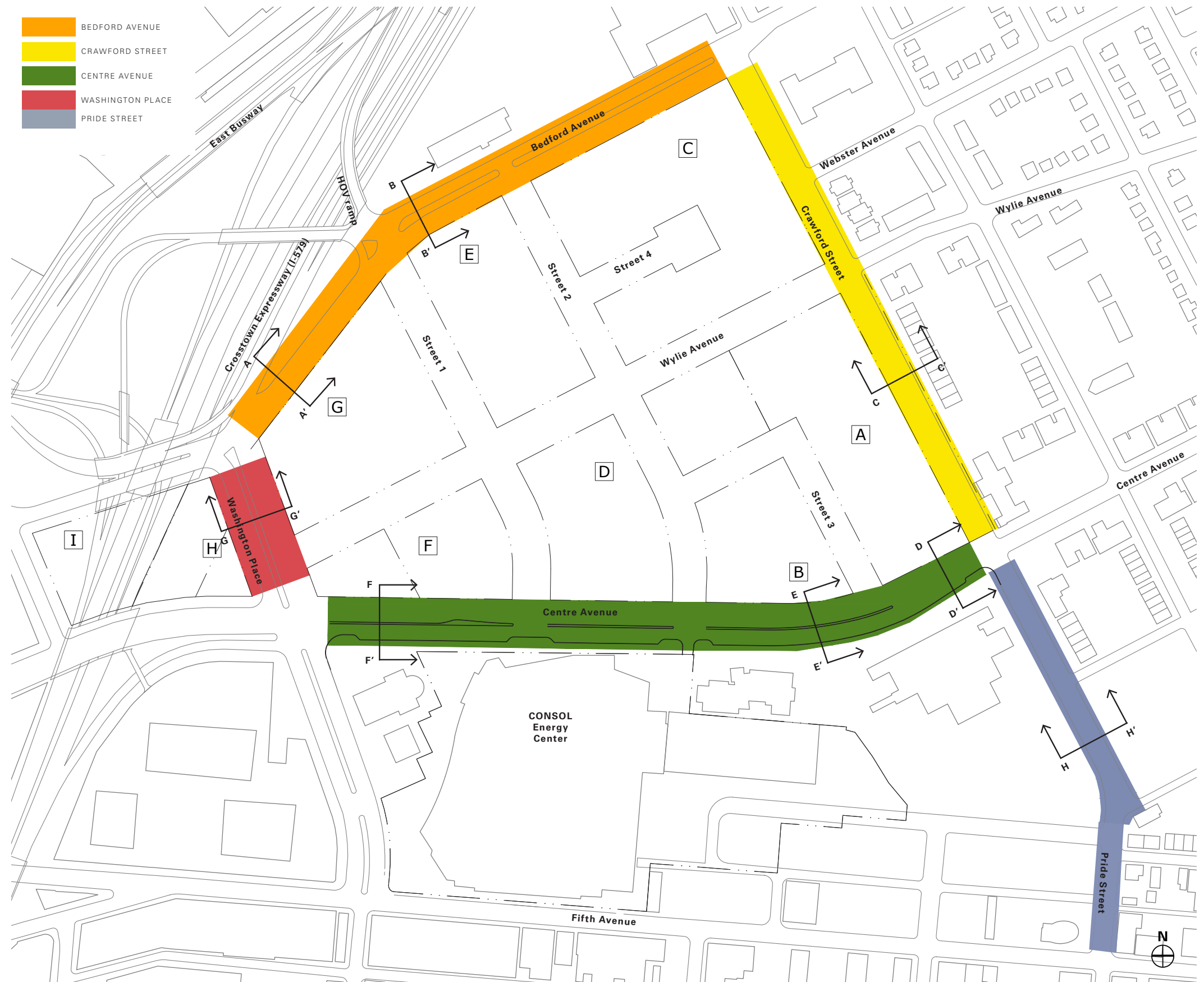
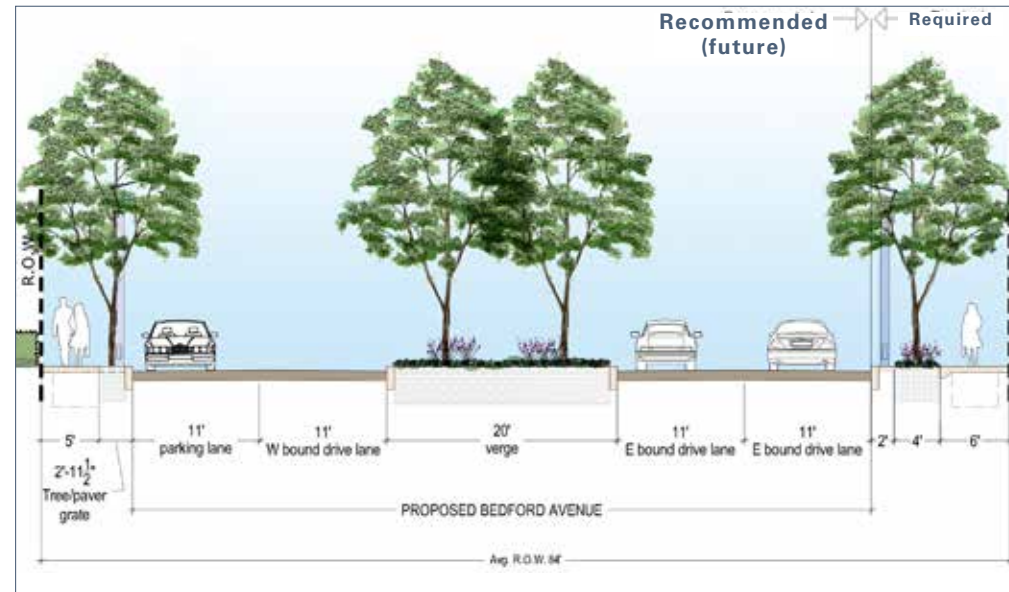
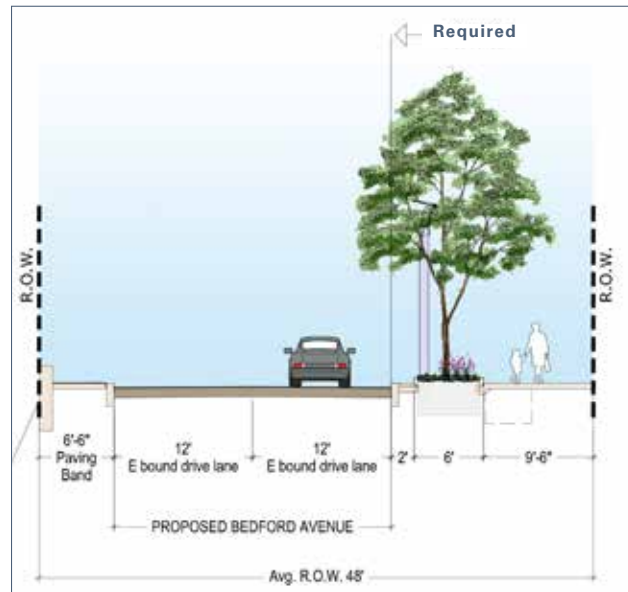

FIGURE 9.2 Perimeter Streets

© 2014 URBAN DESIGN ASSOCIATES



9.1.1 Bedford Avenue



9.1.2 Crawford Avenue

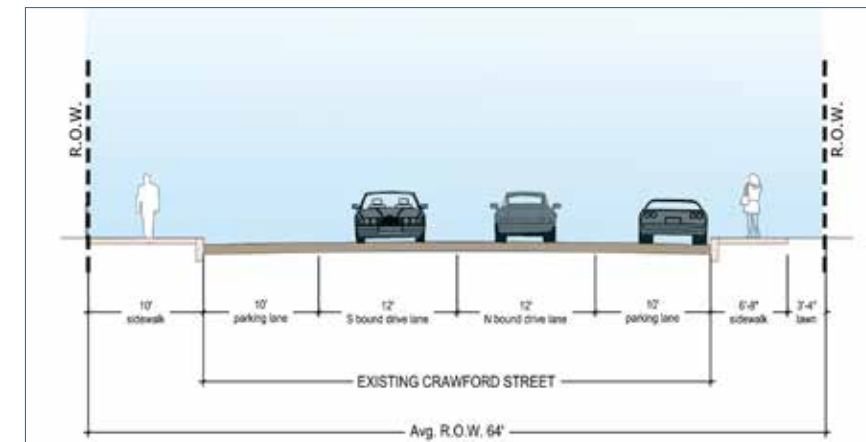
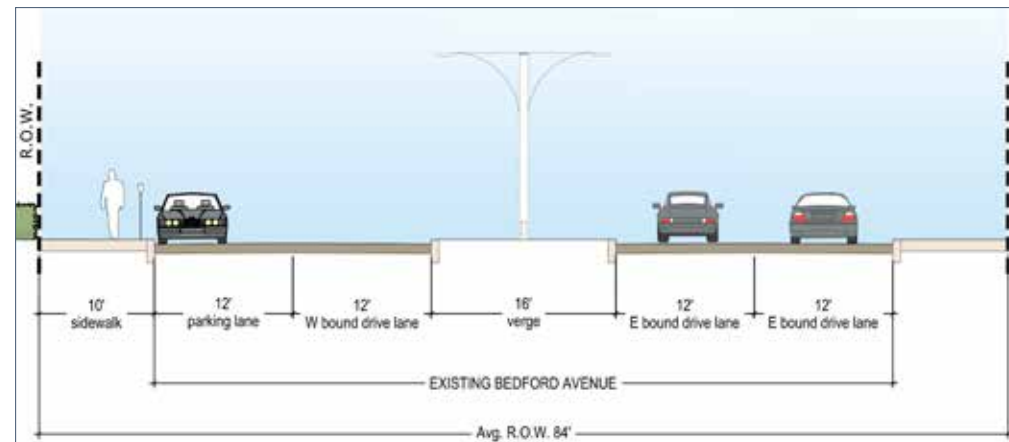
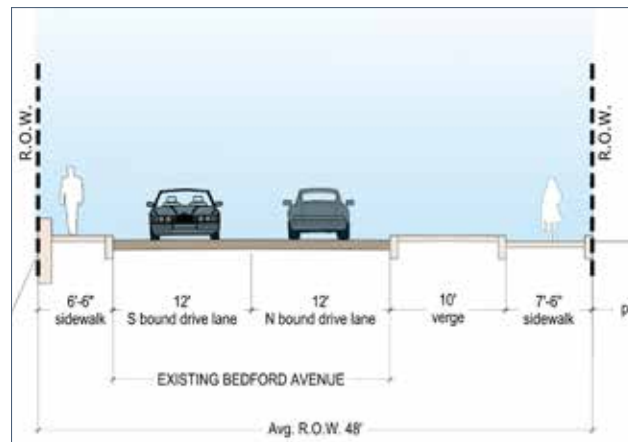
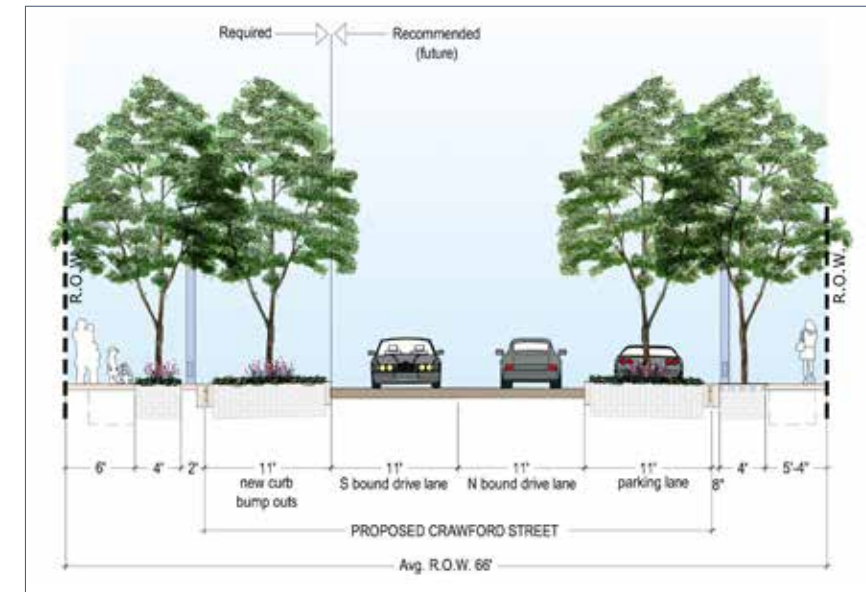

FIGURE 9.3 Bedford Avenue Section A-A'

FIGURE 9.4 Bedford Avenue Section B-B'

FIGURE 9.5 Crawford Street Section C-C'



9.1.3 Centre Avenue

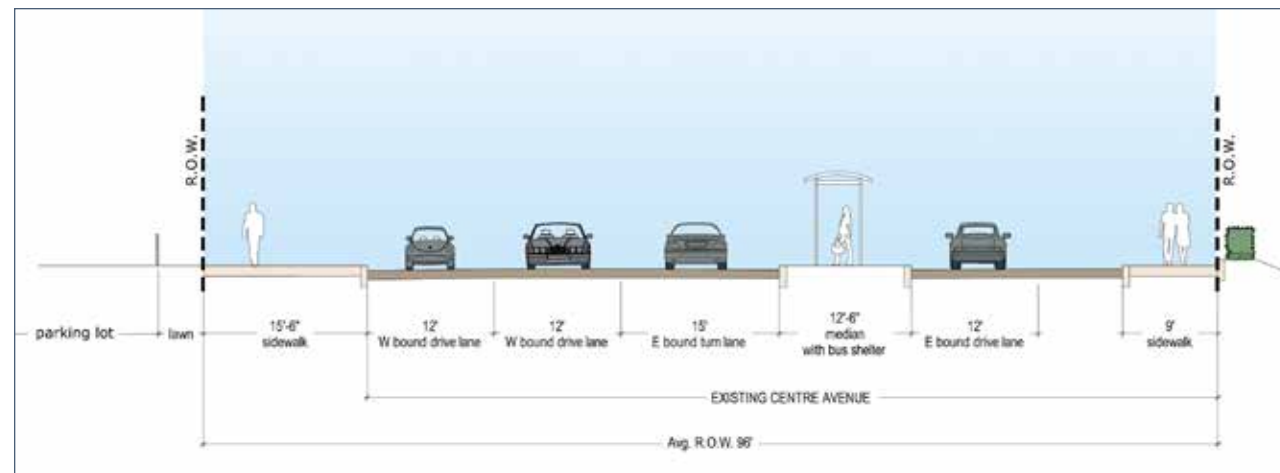
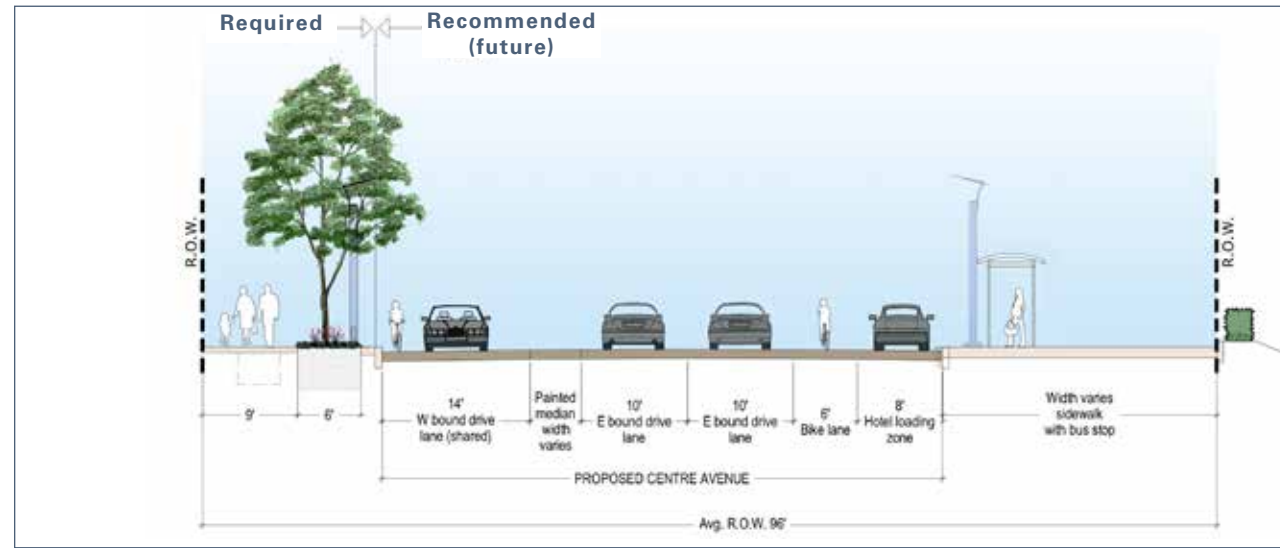

FIGURE 9.6 Centre Avenue Section D-D' (at intersection of Centre and Crawford)

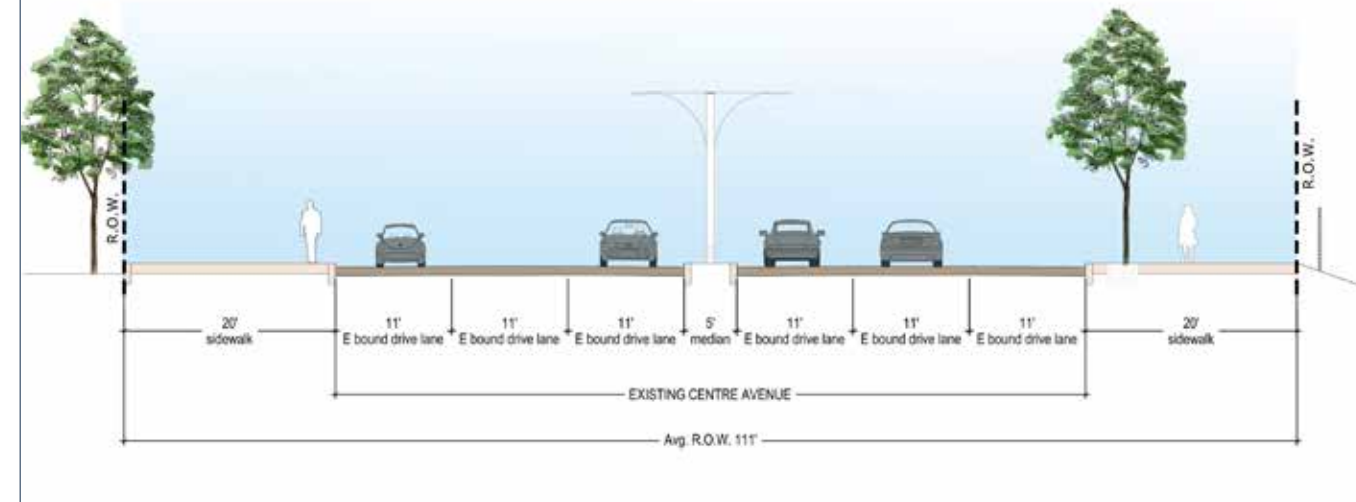
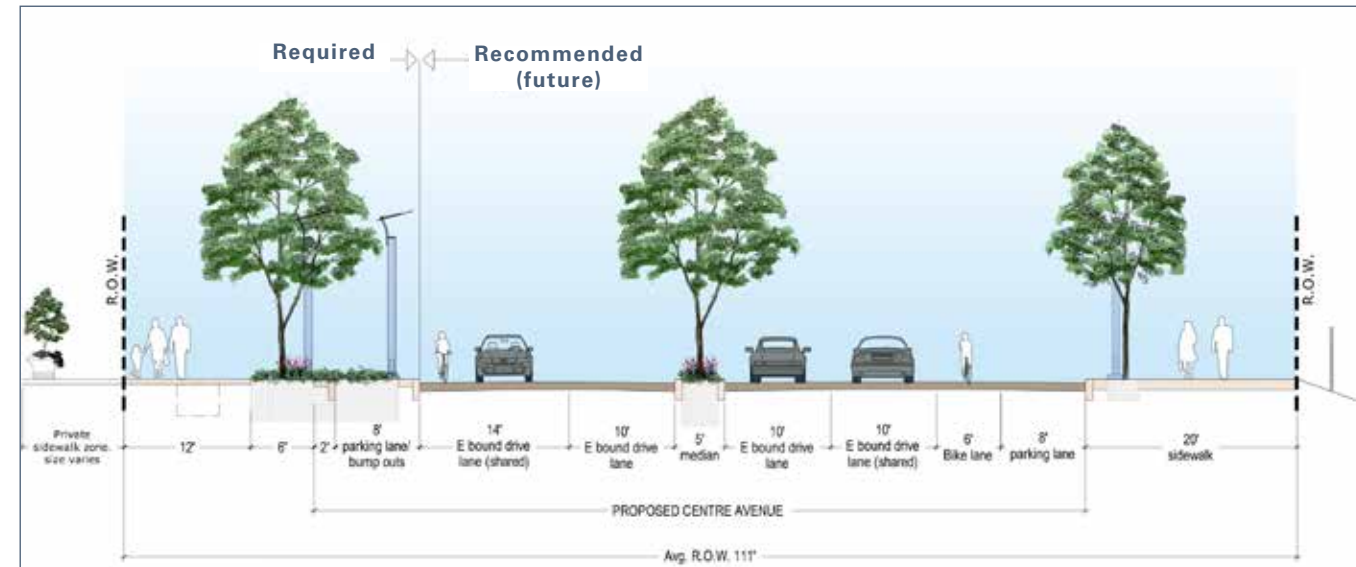
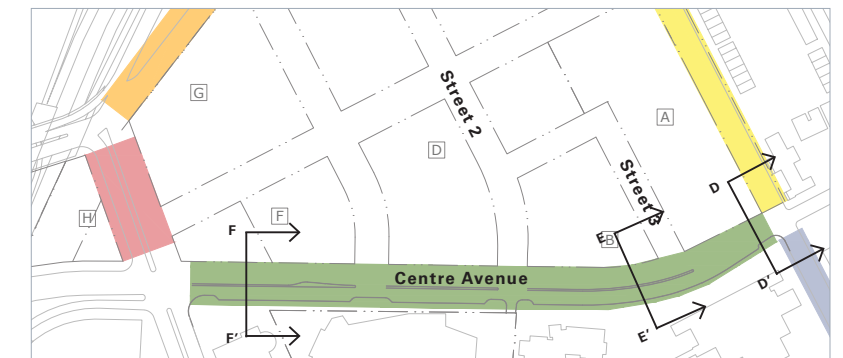

FIGURE 9.7 Centre Avenue Section E-E'





9.1.4 Centre Avenue (continued)

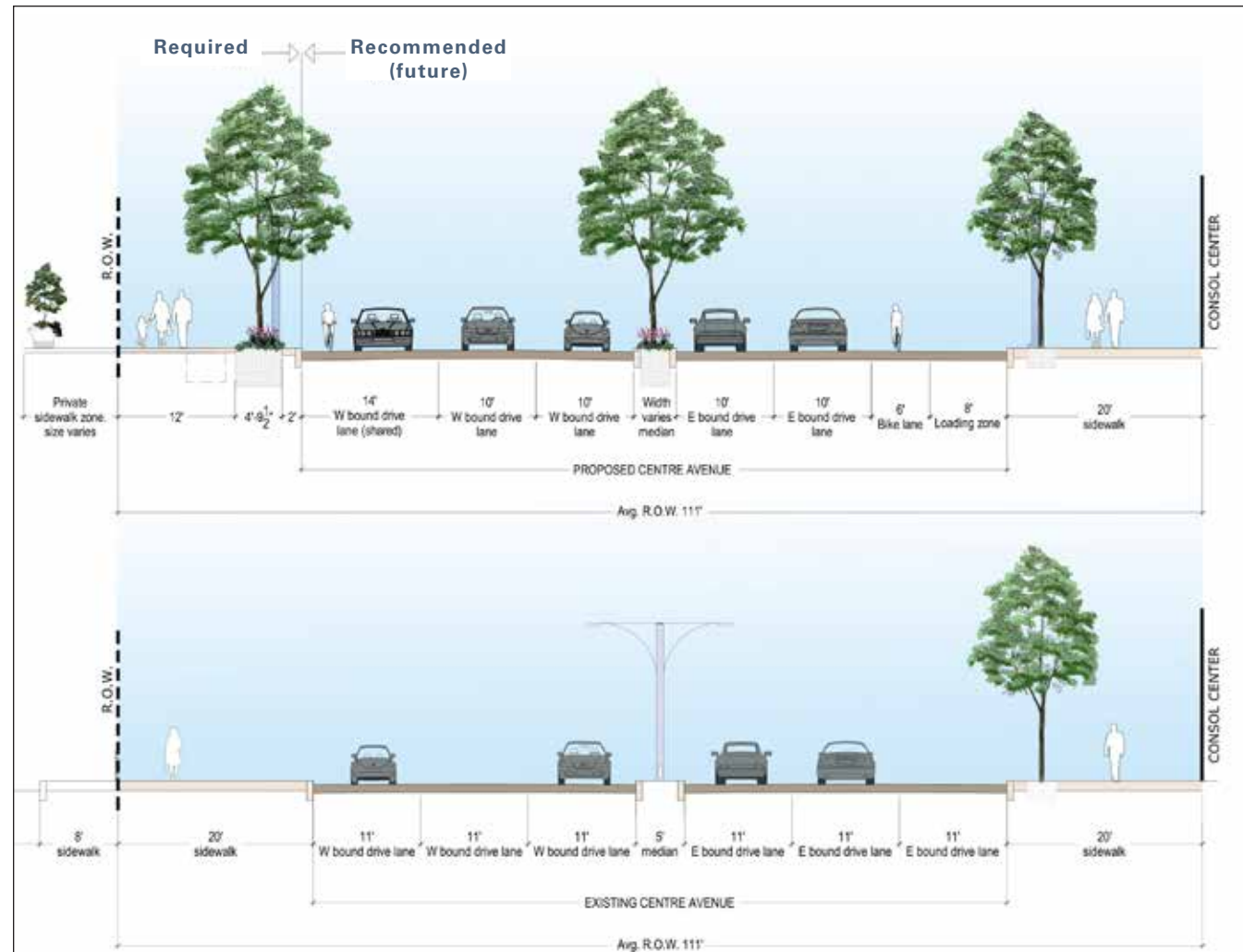

FIGURE 9.8 Centre Avenue Section F-F' (approaching Washington Place)

9.1.5 Washington Place

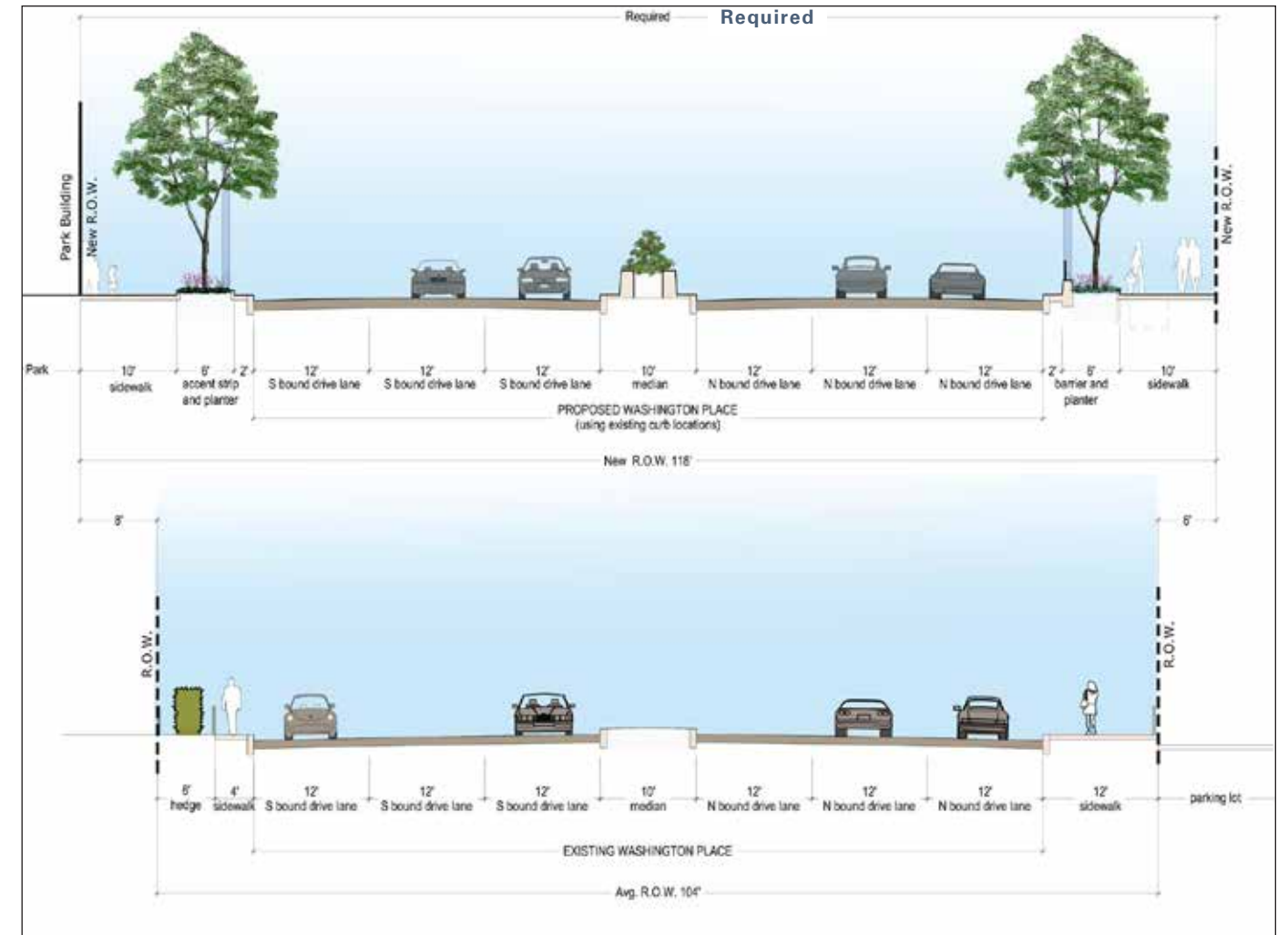

FIGURE 9.9 Washington Place Section G-G'



9.1.6 Pride Street

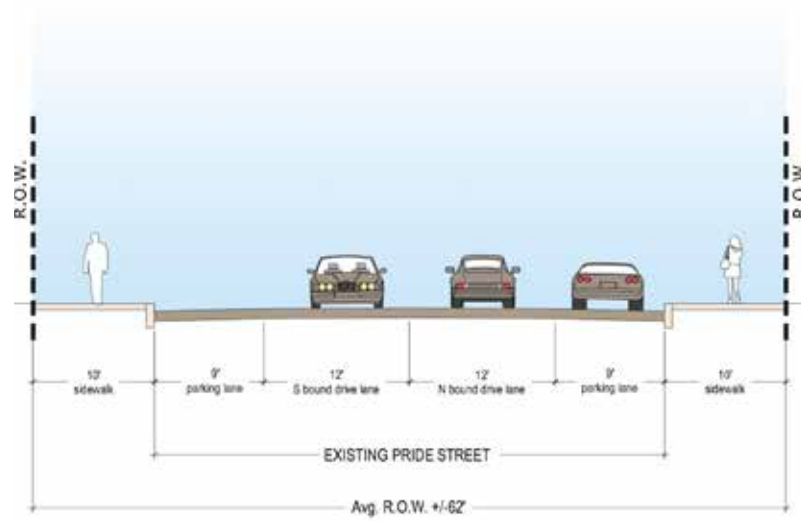
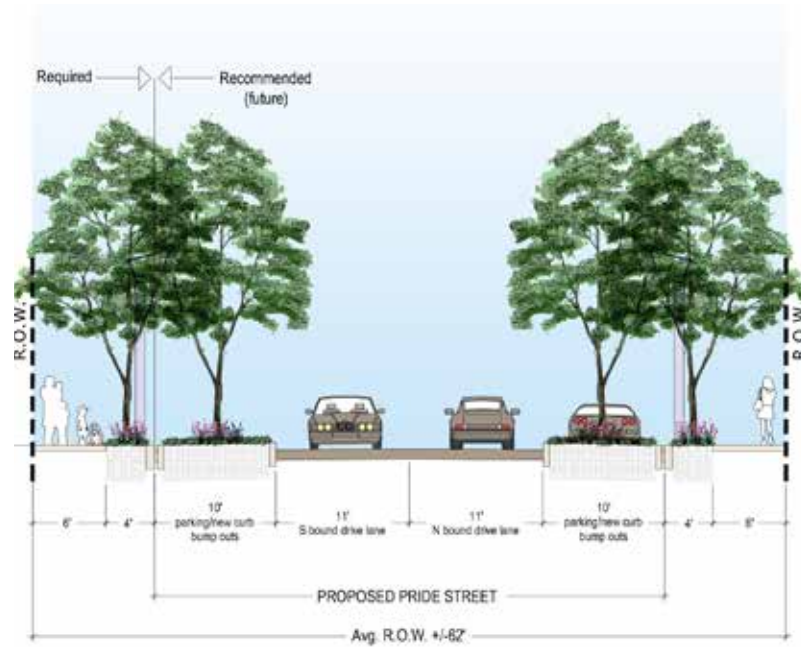
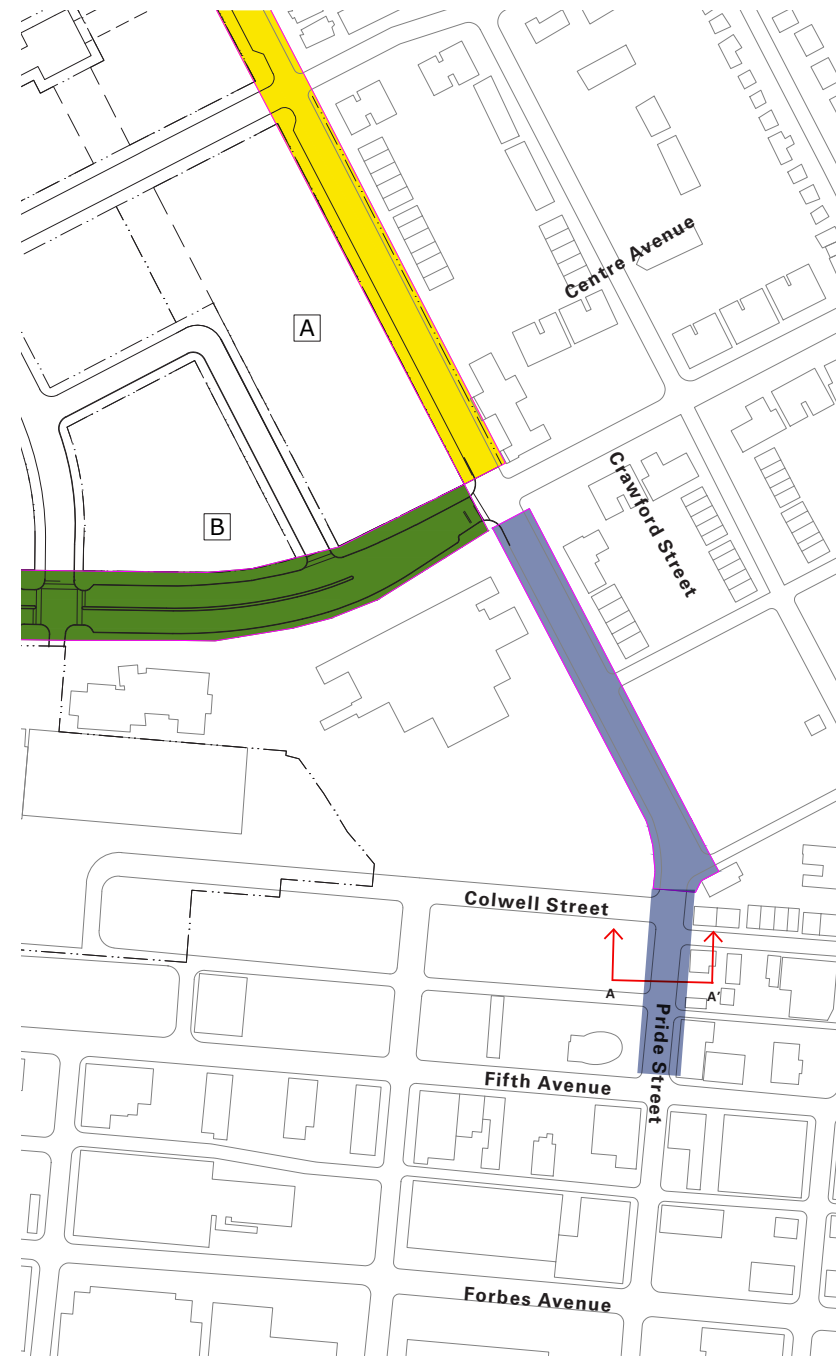







FIGURE 9.10 Pride Street between Centre Avenue and Fifth Avenue



## Sec. 9.2 Intersection Pedestrian Amenities

Intersection pedestrian amenities are planned throughout and surrounding the site, as shown on Figure 9.2. These recommended improvements include:

- » Bump-outs to lessen pedestrian crossing distances and increase pedestrian visibility along Wylie Avenue at: Street 1, Street 2, Washington Place; and Centre Avenue at: Washington Place, Street 1, and Street 2.
- » Stop-controlled intersections, crosswalks and signage internal to the development as shown in Figure 9.9.
- » New pedestrian signal equipment at the new traffic signal at Centre Avenue /Street 1, the new signal at Centre Avenue /Street 2, and the revised signal at Centre Avenue/Crawford Street with crosswalks, pedestrian push-button and countdown equipment, audible pedestrian equipment and ADA ramps.
- » Off-site installation of pedestrian crosswalks, as part of the City of Pittsburgh CBD signals project, at:
  - › Sixth Avenue /Ross Street
  - › Bigelow Square /Chatham Square
  - › Provision of non-mountable median treatment on Washington Place between Centre Avenue and Bedford Avenue, forcing pedestrians to cross at signalized intersections with pedestrian amenities.
  - › Refer to Section 2.9 for parking restrictions.

-  Install Traffic Signal Control
-  Modify Traffic Signal Control/ Optimize Traffic Signal Timings
-  Install "Piano Key" Style Crosswalk
-  Install Brick Paver Crosswalk
-  Install Audible Pedestrian Signal Equipment
-  ①
-  ②

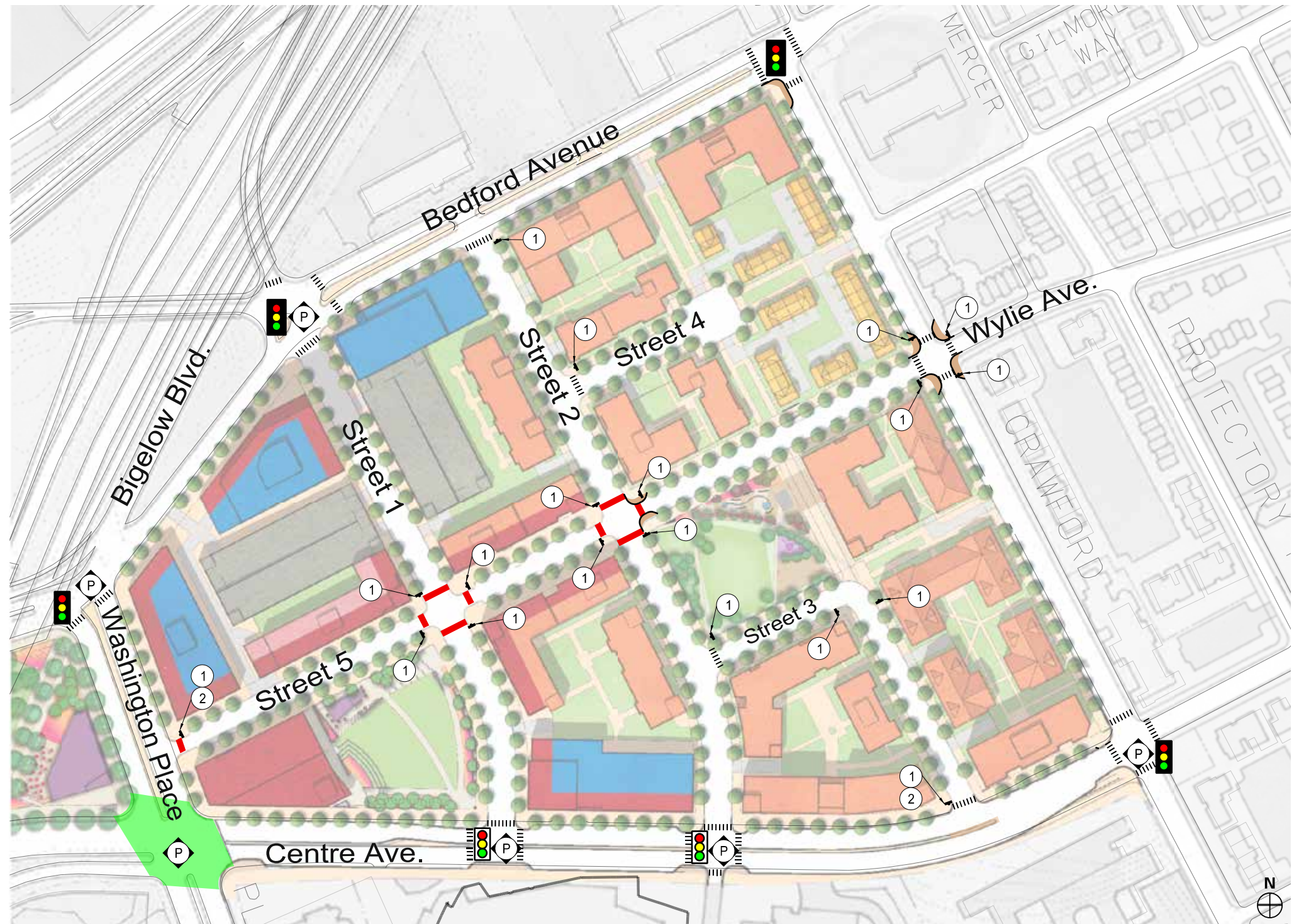

FIGURE 9.11 Roadway Configuration and Recommended Improvements



## Sec. 9.3 Traffic Signalization

Improvements - The recommended roadway and signal improvements are shown in Figures 9.2 and 9.3. These improvements are:

### 9.3.1 Washington Place and Bedford Avenue /Bigelow Boulevard

- » Optimize signal timings.
- » Install audible pedestrian pushbutton and countdown signal equipment.

### 9.3.2 Bedford Avenue and Street 1 /HOV Lanes

- » The Street 1 approach will be relocated as part of the development, with resultant intersection modifications.
- » Construct Street 1 to provide two-lanes northbound and one-lane southbound at its intersection with Bedford Avenue. The northbound Street 1 approach should provide an exclusive left turn lane and a shared through/right turn lane. On-street parking is provided along the western side (southbound) Street 1 from Bedford Avenue to Wylie Avenue. Limited on-street parking will be provided on the southerly end of the east side of the block.
- » Modify the traffic signal control.
- » Install audible pedestrian pushbutton and countdown signal equipment.

### 9.3.3 Bedford Avenue and Street 2

- » Construct Street 2 to provide two-lanes (one in each direction) with on-street parking on both sides from Centre Avenue to Bedford Avenue.
- » The northbound Street 2 approach should provide one (1) lane for all movements onto Bedford Avenue.
- » Open median on Bedford Avenue opposite Street 2.
- » Install stop sign control on the northbound Street 2 approach, permitting both left and right turns onto Bedford Avenue.
- » Install pedestrian crosswalks with handicap accessible ramps across the northbound Street 2 approach.

### 9.3.4 Bedford Avenue and Crawford Street

- » Optimize signal timings.

### 9.3.5 Crawford Street and Wylie Avenue

- » Construct an extension of Wylie Avenue from Crawford Street to Washington Place to provide two-lanes (one in either direction) with on-street parking on both sides. The eastbound Wylie Avenue approach

at its intersection with Crawford should provide one (1) lane for all movements. Install stop sign control on the eastbound Wylie Avenue approach.

- » Install pedestrian crosswalks with handicap accessible ramps across eastbound Wylie Avenue approach.

### 9.3.6 Centre Avenue from Washington Place to Crawford Street

- » Restripe the traffic lanes on Centre Avenue to provide one outboard travel lane westbound that is 14 feet wide and will be designated as shared vehicle-bicycle lanes with sharrow paint markings.
- » Restripe the traffic lanes on Centre Avenue to provide one outboard travel lane eastbound that is 6 feet wide and will be designated as an exclusive bicycle lane with signage and paint markings.
- » Maintain parking and loading lane on the south side of Centre Avenue from Washington Place to Crawford Street.
- » Maintain parking lane on the north side of Centre Avenue from Street 1 to Street 3, with parking prohibited at this location during events.

### 9.3.7 Centre Avenue and Washington Place

- » Install audible pedestrian pushbutton and countdown signal equipment.
- » Intersection and signal improvements to be completed as part of the City's CBD signal project.
- » Apply sharrow lane markings in the outboard travel lane on the north side of Centre Avenue.

### 9.3.8 Centre Avenue and Street 1

- » Construct relocated Street 1 to intersect with Centre Avenue. At this intersection, Street 1 should provide two (2) lanes southbound and one (1) northbound with an on-street parking lane on the eastern (northbound) side of Street 1, from Centre Avenue to Wylie Avenue. The two southbound Street 1 lanes should provide an exclusive left turn lane and an exclusive right turn lane onto Centre Avenue.
- » Construct eastbound Centre Avenue approach to provide three (3) lanes (a shared left turn/through lane, an exclusive through lane and an exclusive bicycle lane) and a drop-off /loading lane for event attendees along CONSOL Energy Center property frontage on the south side of Centre Avenue east of Street 1, with parking on the south side of Centre Avenue west of Street 1.
- » Construct westbound Centre Avenue approach to provide two (2) lanes (an exclusive through lane and a shared vehicle-bicycle shared through/right turn lane) and an on-street parking lane.
- » Apply sharrow lane markings in the outboard travel lane on the north side of Centre Avenue.
- » Install new traffic signal.
- » Optimize traffic signal timings to provide a three-phase signal, an exclusive eastbound advance phase with a southbound right turn overlap phase, an eastbound/westbound phase, and a southbound phase.
- » Install audible pedestrian pushbutton and countdown signal equipment.
- » Install painted crosswalks on all approaches with handicap accessible ramps.

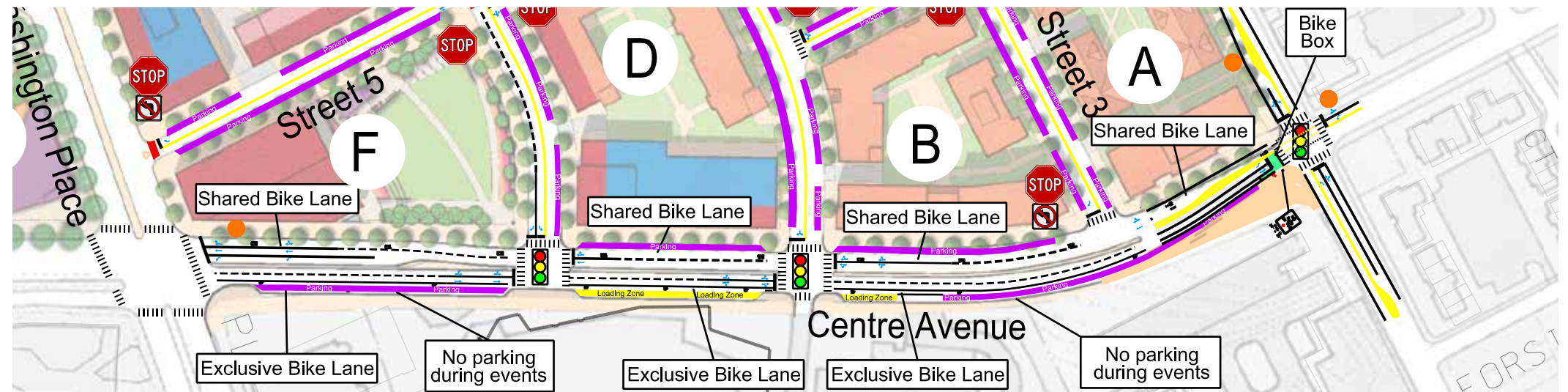

FIGURE 9.12 Centre Avenue Roadway Configuration and Recommended Improvements



### 9.3.9 Centre Avenue and Street 2/CONSOL Energy Center parking garage driveway

- » Construct Street 2 opposite the existing CONSOL Energy Center parking garage driveway. Street 2 should provide one (1) lane shared left turn/through/right turn lane southbound with an on-street parking lane and one (1) northbound lane with an on-street parking lane.
- » Construct eastbound Centre Avenue approach to provide three (3) lanes (a shared left turn/through lane, a shared through/right turn lane and exclusive bicycle lane) and a drop-off/ loading lane for event attendees along CONSOL Energy Center property frontage west of Street 2, with parking on the south side of Centre Avenue east of Street 2.
- » Construct westbound Centre Avenue approach to provide two (2) lanes (a shared left turn/through lane and a shared vehicle-bicycle shared through/right turn lane) and an on-street parking lane.
- » Apply sharrow lane markings in the outboard travel lane on the north side of Centre Avenue.
- » Install new two-phase traffic signal.
- » Install audible pedestrian pushbutton and countdown signal equipment.
- » Install painted crosswalks on all approaches with handicap accessible ramps.

### 9.3.10 Centre Avenue and Street 3

- » Construct Street 3 to provide two-lanes (one in each direction) with onstreet parking on both sides from Centre Avenue to Street 2.
- » The southbound Street 3 approach should provide an exclusive right turn lane only.
- » Install stop sign control on the southbound Street 3 approach.
- » Install No Left Turn signage for the southbound Street 3 approach.
- » Construct a concrete median along Centre Avenue to prohibit the left turn movements into and out of Street 3.
- » Apply sharrow lane markings in the outboard travel lane on the north side of Centre Avenue.
- » Install pedestrian crosswalks with handicap accessible ramps across the southbound Street 3 approach.

### 9.3.11 Centre Avenue and Crawford Street

- » Install audible pedestrian pushbutton and countdown signal equipment.
- » Relocate the curbline on the south side of Centre Avenue 10 feet north to improve the alignment of the Centre Avenue through lanes eastbound and westbound across Crawford Street.
- » Modify the eastbound Centre Avenue approach to provide an exclusive left turn lane, a through-right lane, and an exclusive bike lane terminating in a bike box, in conjunction with removal of the island on eastbound Centre Avenue at the right turn lane, and relocation of the bus shelter onto the sidewalk.
- » Apply sharrow lane markings in the outboard travel lane on the north side of Centre Avenue.
- » Remove on-street parking on the west side of southbound Crawford Street to provide an exclusive left turn lane, mirrored by a northbound exclusive left turn lane on Crawford Street.
- » Provide crosswalks on all approaches to the intersection.
- » Upgrade the traffic signal to provide three phase operation, adding a phase for northbound Crawford Street movements to run exclusively.

### 9.3.12 Washington Place and Wylie Avenue

- » Construct Wylie Avenue extension, from Crawford Street Washington Place, to provide two-lanes (one in each direction) with on-street parking on both sides from Washington Place to Crawford Street.
- » The westbound Wylie Avenue approach should provide an exclusive right turn lane only.
- » Install stop sign control on the westbound Wylie Avenue approach.
- » Install No Left Turn signage for the westbound Wylie Avenue approach.
- » Construct a concrete median along Washington Place to prohibit left turn movements into and out of Wylie Avenue.
- » Install pedestrian crosswalks with handicap accessible ramps across Wylie Avenue.

### 9.3.13 Wylie Avenue and Street 1

- » Construct the eastbound and westbound Wylie Avenue approaches to provide a shared left turn/through/right turn lane with an on-street parking lane on each approach.
- » Construct the northbound and southbound Street 1 approaches to provide a shared left turn/through/right turn lane with an on-street parking lane.
- » Install stop sign control on all approaches. The proposed intersection will operate as a 4-way stop controlled intersection.
- » Install pedestrian crosswalks with handicap accessible ramps on all approaches.

### 9.3.14 Wylie Avenue and Street 2

- » Construct the eastbound and westbound Wylie Avenue approaches to provide a shared left turn/through/right turn lane with an on-street parking lane.
- » Construct the northbound and southbound Street 2 approaches to provide a shared left turn/through/right turn lane with an on-street parking lane.
- » Install stop sign control on all approaches. The proposed intersection will operate as a 4-way stop controlled intersection.
- » Install pedestrian crosswalks with handicap accessible ramps on all approaches.

### 9.3.15 Street 2 and Street 3

- » Construct the westbound Street 3 approach to provide a shared left-turn/right turn lane with an on-street parking lane.
- » Construct the northbound Street 2 approach to provide a shared through/right turn lane with an on-street parking lane.
- » Construct the southbound Street 2 approach to provide a shared left turn/through lane with an on-street parking lane.
- » Install stop sign control on the westbound Street 3 approach.
- » Install pedestrian crosswalk with handicap accessible ramps on the westbound Street 3 approach.



**9.3.16 Street 2 and Street 4**

- » Construct the westbound Street 4 approach to provide a shared left turn/right turn lane with an on-street parking lane.
- » Construct the northbound Street 2 approach to provide a shared through/right turn lane with an on-street parking lane.
- » Construct the southbound Street 2 approach to provide a shared left turn/through lane with an on-street parking lane.
- » Install stop sign control on the westbound Street 4 approach.
- » Install pedestrian crosswalk with handicap accessible ramps on the westbound Street 4 approach.

**9.3.17 Centre Avenue and Sixth Avenue**

- » Optimize signal timings.

**9.3.18 Fifth Avenue and Sixth Avenue**

- » Optimize signal timings.

**9.3.19 Forbes Avenue and Armstrong Tunnel**

- » Optimize signal timings.

**9.3.20 Sixth Avenue and Ross Street**

- » Signal optimization.
- » Install audible pedestrian pushbutton and countdown signal equipment.
- » Install pedestrian crosswalks.

**9.3.21 Chatham Square and Bigelow Square/Bigelow Boulevard**

- » Signal optimization.
- » Install audible pedestrian pushbutton and countdown signal equipment.
- » Install pedestrian crosswalks.
- » It should be noted that intersections included in the CBD signal project, which will be designed and updated as part of the City's project, include the following:
  - » Ross Street/Sixth Street Avenue – new signal, no construction date yet;
  - » Chatham Square/Bigelow Square/Bigelow – new signal, no construction date yet;
  - » Washington Place/Centre Avenue – construction scheduled for 2014;
  - » Washington Place/Bedford Avenue – new signal, no construction date yet;
  - » Bedford Avenue/HOV Lane/Mario Lemieux Place (Street 1) – new signal, no construction date yet;
  - » Bedford Avenue/Crawford – new signal, no construction date yet; and
  - » Centre Avenue/Crawford – new signal, no construction date yet.
- » In addition to improvements presented, transportation conditions in this area can be significantly enhanced for several travel modes by implementation of the following measures:
  - » Providing public transit access by the Port Authority of Allegheny County (PAAC). Routes and stop locations will be further discussed with PAAC. Street 1 will be constructed to accommodate bus traffic between Bedford Avenue and Centre Avenue.
  - » Providing wide sidewalks with pedestrian crosswalks and handicap accessible ramps at all proposed new intersections.
  - » Provide bump outs on roadways within and surrounding the development site as indicated on Figures 28 and 29, to reduce pedestrian crossing distances and to improve visibility of pedestrians for motorists.
  - » Optimizing signalized intersection offsets times.

**9.3.22 Event Management**

- » On-street parking will be prohibited before, during, and after event as follows:
  - » On the east side of Street 1 between Centre Avenue and Bedford Avenue in order to provide two continuous northbound lanes exiting the area;
  - » On the west side of Street 1 between Bedford Avenue and Wylie Avenue in order to provide two continuous southbound lanes on Street 1
  - » On both sides of Street 2 between Centre Avenue and Bedford Avenue in order to provide two continuous lanes in both directions along Street 2;
  - » On the south side of Bedford Avenue between Street 1 and Street 2;
  - » On the north side of Centre Avenue between Crawford Street and Street 1; and
  - » On the north side of Bedford Avenue between Street 1 and Crawford Street.
  - » On the west side of Crawford between Centre Ave. and Bedford Ave.

A summary of the traffic and pedestrian control improvements are presented in Figure 9.9. The conceptual Centre Avenue roadway improvements are presented in Figure 9.10.

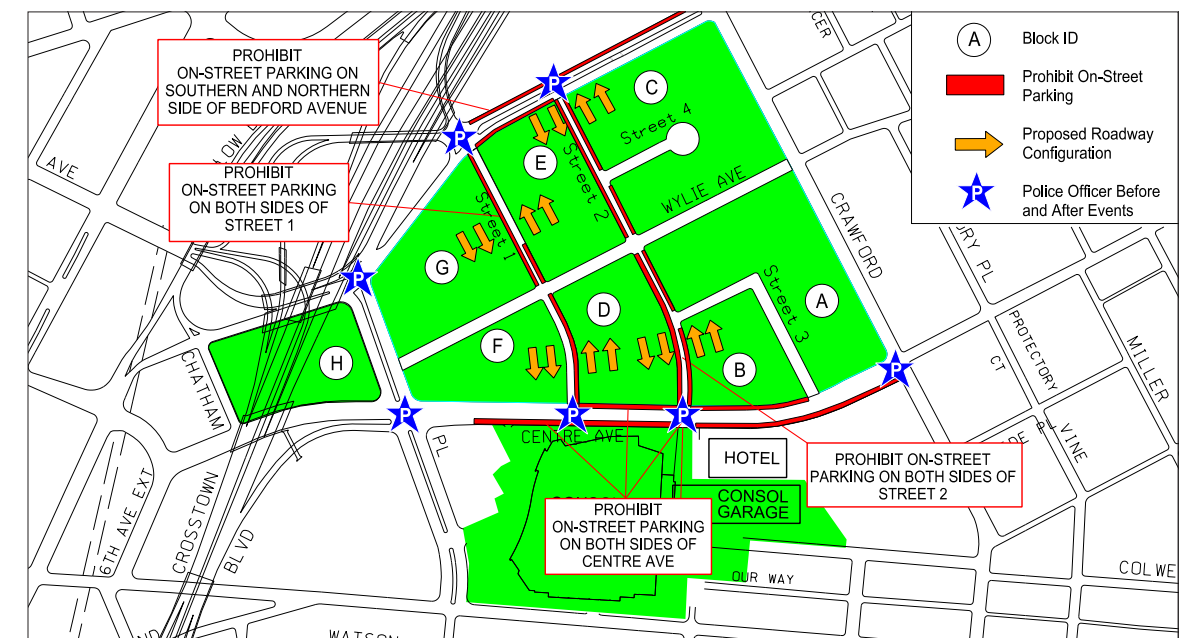

FIGURE 9.13 Event Management Plan (Maximum Size Event)





# Intent & Implementation: Section 10–12

## Section 10. Illustrative Master Plan

Sec. 10.1 Introduction	99
Sec. 10.2 Illustrative Block A	101
Sec. 10.3 Illustrative Block B	102
Sec. 10.4 Illustrative Block C	103
Sec. 10.5 Illustrative Block D	104
Sec. 10.6 Illustrative Block E	105
Sec. 10.7 Illustrative Block F	106
Sec. 10.8 Illustrative Block G	107
Sec. 10.9 Illustrative Block H	108
Sec. 10.10 Multi-User Parking Application	109



## Sec. 10.1 Introduction

The PLDP establishes a framework within which specific development proposals can be brought forth at a later date. The final master plan will be documented in the FLDP once developers come forth with an implementation plan. Because the PLDP establishes a flexible set of parameters for development, the final form of the blocks cannot be predicted at this time.

In order to provide a visual of the development capacity and potential physical form, a series of three dimensional views were created. The model images to the right provide three-dimensional mapping of the minimum and maximum building height allowances prescribed in the Building Height Regulating Plan. All new buildings must fall within this range. While the final development plan is yet to be defined, these models illustrate the flexibility of the guidelines. The pages illustrate one potential plan scenario.

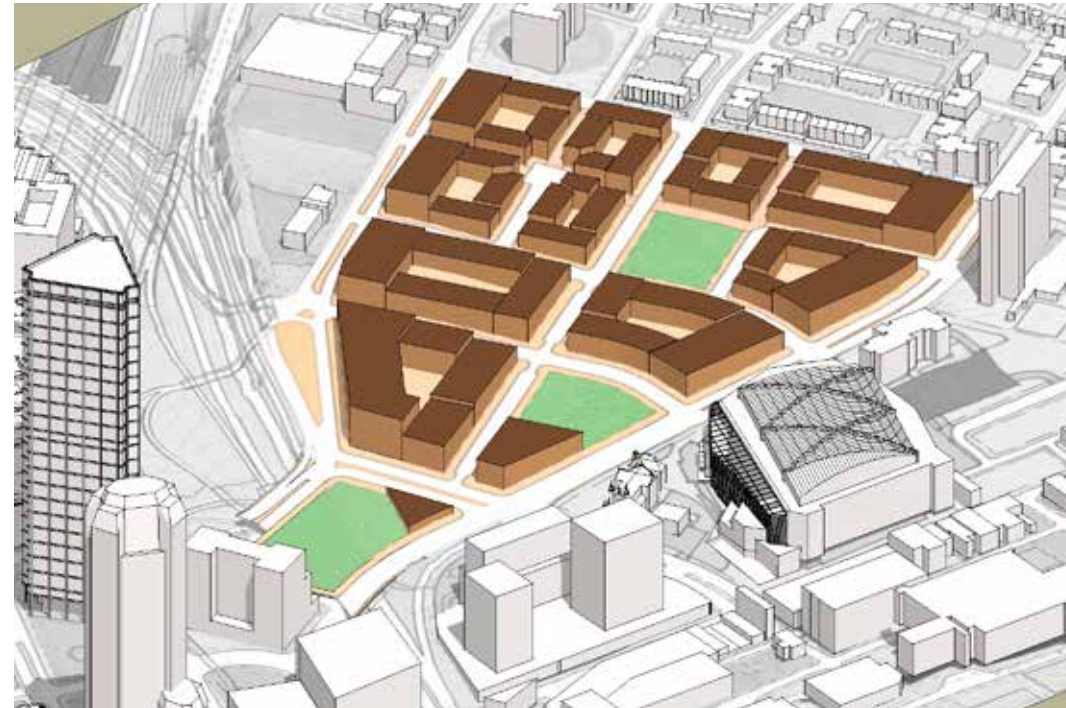

FIGURE 10.1 Massing model of minimum building height requirements (refer to Section 2.8)

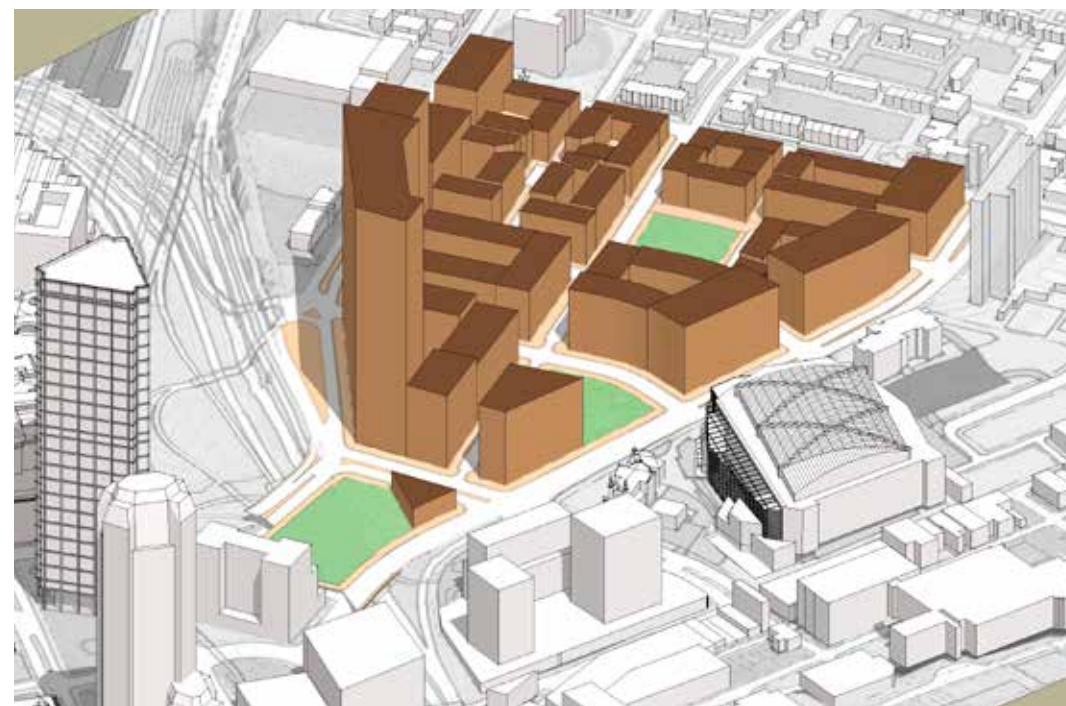

FIGURE 10.2 Massing model of maximum building height requirements (refer to Section 2.8)



The Illustrative Master Plan to the right is an illustration of the regulating plans, and illustrates potential development on the site. A street grid, reflecting some of the historic streets provides a new network. New Type I and Type II buildings (see Section 4) are intended to line Crawford Street reinforcing the successful Crawford Square development across the street. On the blocks closest to Downtown, office buildings and mid-rise apartments are intended to be built with ground floor shops and restaurants. An entertainment retail environment is envisioned for the core of the Site surrounding a Major Public Destination Facility Plaza (also referred to as Civic Open Space). A second Community Open Space further east in the plan will focus more on enhancing the residential character of that portion of the Site. In order to establish the desired urban framework for redevelopment, the capacity of each block was studied in detail. The natural features of the site, situated on a significant incline, strongly affect the layout and capacity of each block. Substantial changes in grade within a single block result in opportunities for stepped building typologies, hidden garage levels, and a “hidden” increase in building heights. By increasing heights as the grade slopes downhill, tall buildings can exist at lower elevations without compromising sight lines to Downtown.

While the street grid and changing grade allows for a variety of options in developing each block, the studies which follow reflect the proposed Illustrative Master Plan and corresponding program.



FIGURE 10.3 Illustrative Master Plan

TABLE 10.4 Concept Development Program

Residential	1,188 units
Retail/Commercial/Entertainment	248,800 SF
Office	632,000 SF
Hotel	150 rooms
Structured Parking	2,457 cars
Parks Space	2.8 acres
Other Open Space	3.1 acres



## Sec. 10.2 Illustrative Block A

Situated along Crawford Street between Centre Avenue and Wylie Avenue, this block is a gateway for the site from two main approaches. The block has two different scales: an urban scale along Centre and a neighborhood scale along Crawford, Fullerton and Wylie. Building heights along Crawford Street should correspond to the scale of houses in Crawford Square. At the corner of Centre Avenue and Crawford Street, buildings should be designed to relate to St. Benedict the Moor Church and Freedom Corner. Portions of the frontage along Centre Avenue may accommodate a tall building with active ground floor uses, while residential frontage is recommended for the rest of the block. The block is bisected by a private alley easement, which can serve as both a pedestrian mews and a parking drive. The northern part of the block forms one edge of a new neighborhood park.

The Illustrative Master Plan illustrates one possible solution to parking. Two podium garages create level platforms for residential courtyards, which are wrapped by housing. On the downhill side, two-story liner townhouses conceal the parking decks from public view. Two building types are shown, a high-rise residential tower that compliments Washington Place across Centre Avenue, and four-story courtyard apartment buildings.



FIGURE 10.7 Program Model



FIGURE 10.8 Illustrative Block Plan

TABLE 10.6 Block A Potential Program

Type I Buildings	15 units
Multi-family Apartments (Type II)	329 units
Retail/Commercial	13,390 SF
Podium Parking	365 cars
Park	1 acre



FIGURE 10.5 Section Locator Plan

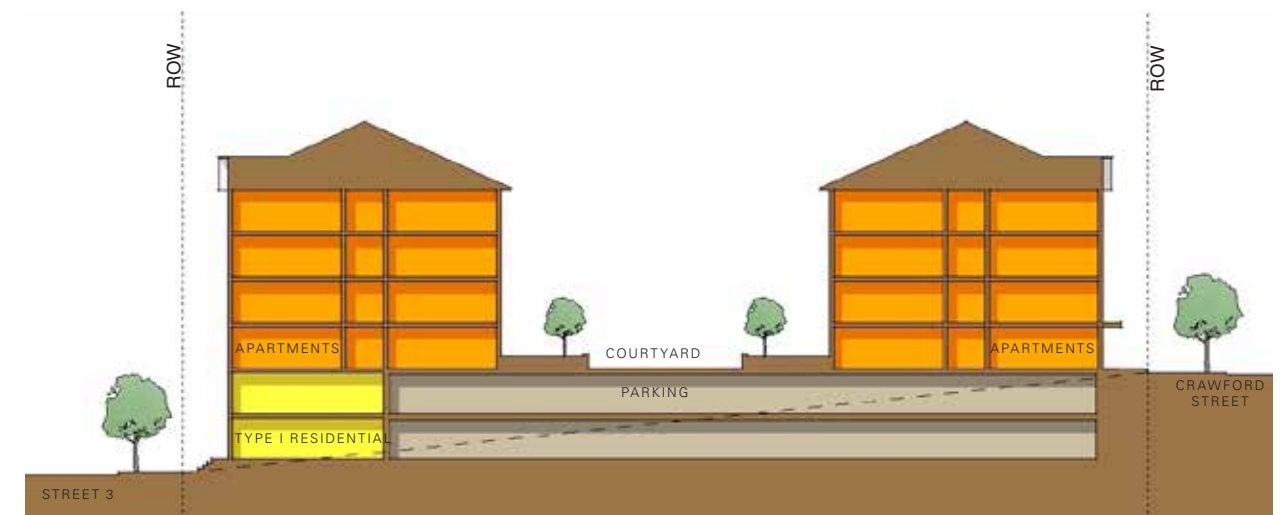

FIGURE 10.9 Block Section



## Sec. 10.3 Illustrative Block B

Block B is a diverse block in a prominent location within the site. The north side of the block is a one-acre community park, designated primarily for the benefit of residents of the Lower Hill Site Redevelopment. At the south end of the block, tall buildings are permitted along Centre Avenue and can accommodate active ground floor uses. Street 3 will be primarily residential in character. Street 2 will be an important entry street from Centre Avenue, with a wider right-of-way to accommodate more traffic. Community related functions should be integrated into buildings facing Street 2 and the park. Although a number of uses are permitted for this block, the conceptual design illustrated here is predominantly residential in use. Similar to Block A, parking is partially submerged in a podium at the center of the block with a rooftop courtyard. A community facility lines the parking structure at street-level along Street 2 and the park.



FIGURE 10.12 Program Model

TABLE 10.10 Block B Potential Program

Multi-Family Apartments (Type II Buildings)	223 units
Retail/Commercial	10,910 SF
Community Space	8,800 SF
Podium Parking	247 cars



FIGURE 10.11 Section Locator Plan



FIGURE 10.13 Illustrative Block Plan

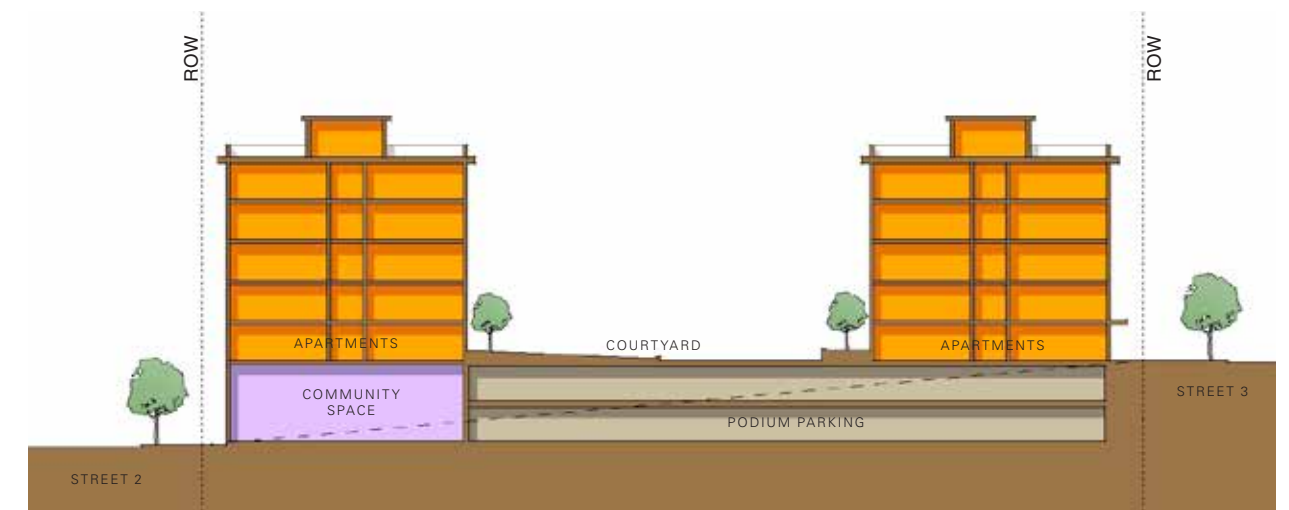

FIGURE 10.14 Block Section



## Sec. 10.4 Illustrative Block C

The steep slope of the northeast part of the site creates many challenges for the design of this block. The topographic constraints make it difficult to divide the block into smaller blocks with streets, so the block is subdivided into four areas by three private alley easements. The easements can be landscaped or hardscape areas used for vehicular and pedestrian access and connections. As illustrated, the four quadrants are flexible enough to accommodate various building types, building scales, and parking solutions. Taller buildings are permitted along Bedford Avenue to reinforce the boulevard character of the street and to take advantage of skyline and Allegheny River Valley views. Smaller-scale buildings are required along Crawford Avenue to match the character of adjacent housing. Buildings are designed to terrace downhill with every effort made to address streets with front porches and entry stoops. Entry to basement parking is located on the downhill sides of buildings to minimize grading and to work with the slope of the streets. The section illustrates how units and parking may be nested into the slope and grading may be managed to minimize site retaining walls.



FIGURE 10.17 Program Model

TABLE 10.15 Block C Potential Program

Type I Buildings	29 units
Multi-family Apartments (Type II Buildings)	326 units
Podium Parking	331 cars
Integral Parking	29 cars



FIGURE 10.16 Section Locator Plan



FIGURE 10.18 Illustrative Block Plan

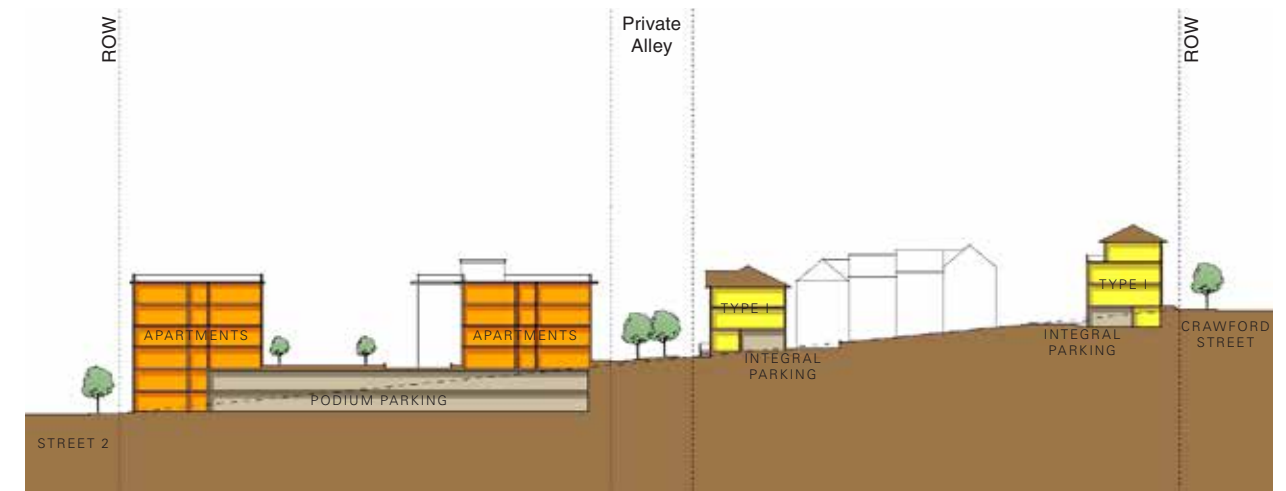

FIGURE 10.19 Block Section



## Sec. 10.5 Illustrative Block D

Block D is located in a prime location within the site, flanked by two new parks and across the street from the CONSOL Energy Center. To capitalize on advantageous location, the frontages along Wylie Avenue, Street 1, and Centre Avenue will be commercial in character, and retail and entertainment uses are encouraged here. The Street 2 frontage will be residential in character. Taller buildings will be permitted along Centre Avenue and Street 1 to complement the building mass of the CONSOL Energy Center district and to create a strong urban wall around the eastern edge of the park. Office and residential uses are recommended for the upper floors of buildings. A possible configuration of the block is illustrated to the right. Like adjacent blocks, parking can be terraced into the hillside to create a platform for new buildings. This conceptual design features a semi-private courtyard in the center of the block that enhances pedestrian connectivity between the buildings and surrounding streets.



FIGURE 10.22 Program Model

TABLE 10.20 Block D Potential Program

Multi-Family Apartments (Type II Buildings)	141 units
Retail/Commercial	42,200 SF
Office	116,000 SF
Podium Parking	305 cars

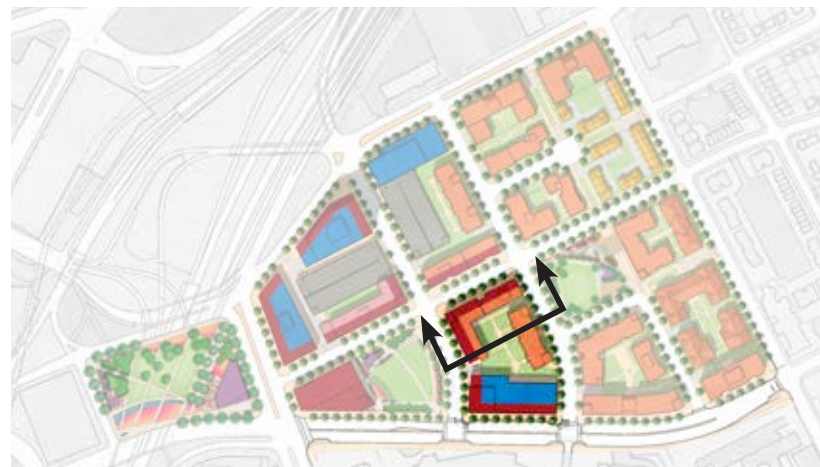

FIGURE 10.21 Section Locator Plan



FIGURE 10.23 Illustrative Block Plan

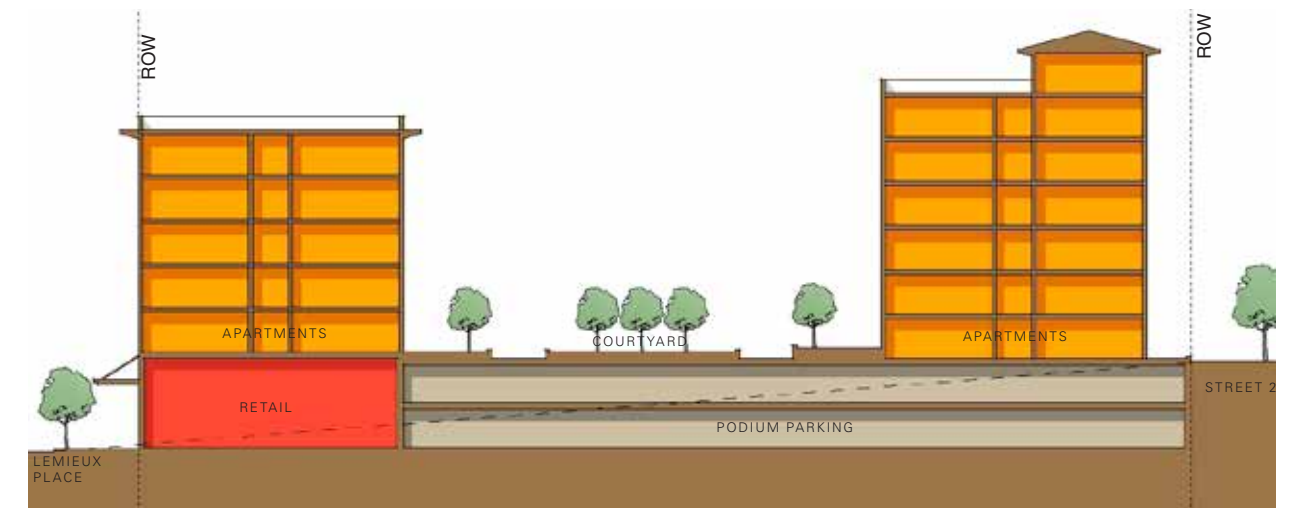

FIGURE 10.24 Block Section



## Sec. 10.6 Illustrative Block E

Along with Block D, Block E transitions from the residential character of the upper part of the site to the denser, more commercial character of the lower part of the site. Retail and entertainment uses are encouraged along Wylie Avenue and if possible along Street 1. A freestanding garage building is permitted in this block to allow increased development density, both in this block as well as in surrounding blocks. The provision for additional parking capacity at this location is part of a coordinated parking strategy for the entire site. If the market demand exists, development density on this block may be higher than what is illustrated in the Illustrative Block Plan. Taller buildings are permitted along Bedford Avenue to capture spectacular views of the city and Allegheny River Valley, and to be visible from the expressway.



FIGURE 10.27 Program Model

TABLE 10.25 Block E Potential Program

Multi-Family Apartments (Type II Buildings)	124 units
Retail/Commercial	14,415 SF
Office	108,370 SF
Garage Parking	343 cars
Podium Parking	138 cars

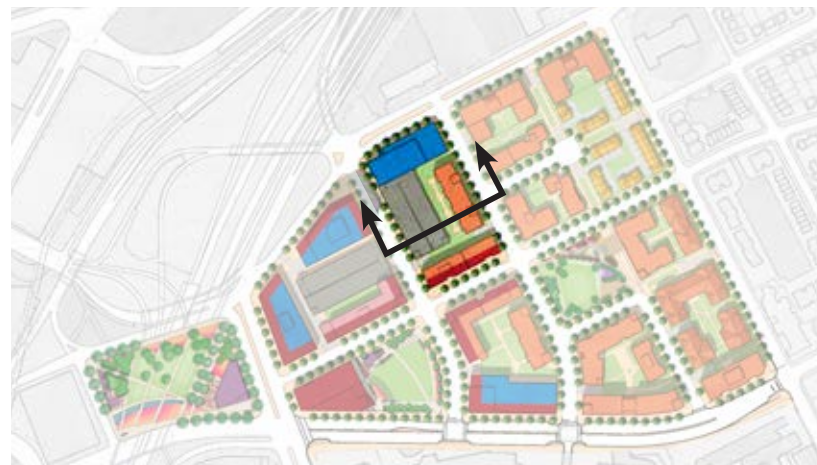

FIGURE 10.26 Section Locator Plan



FIGURE 10.28 Illustrative Block Plan

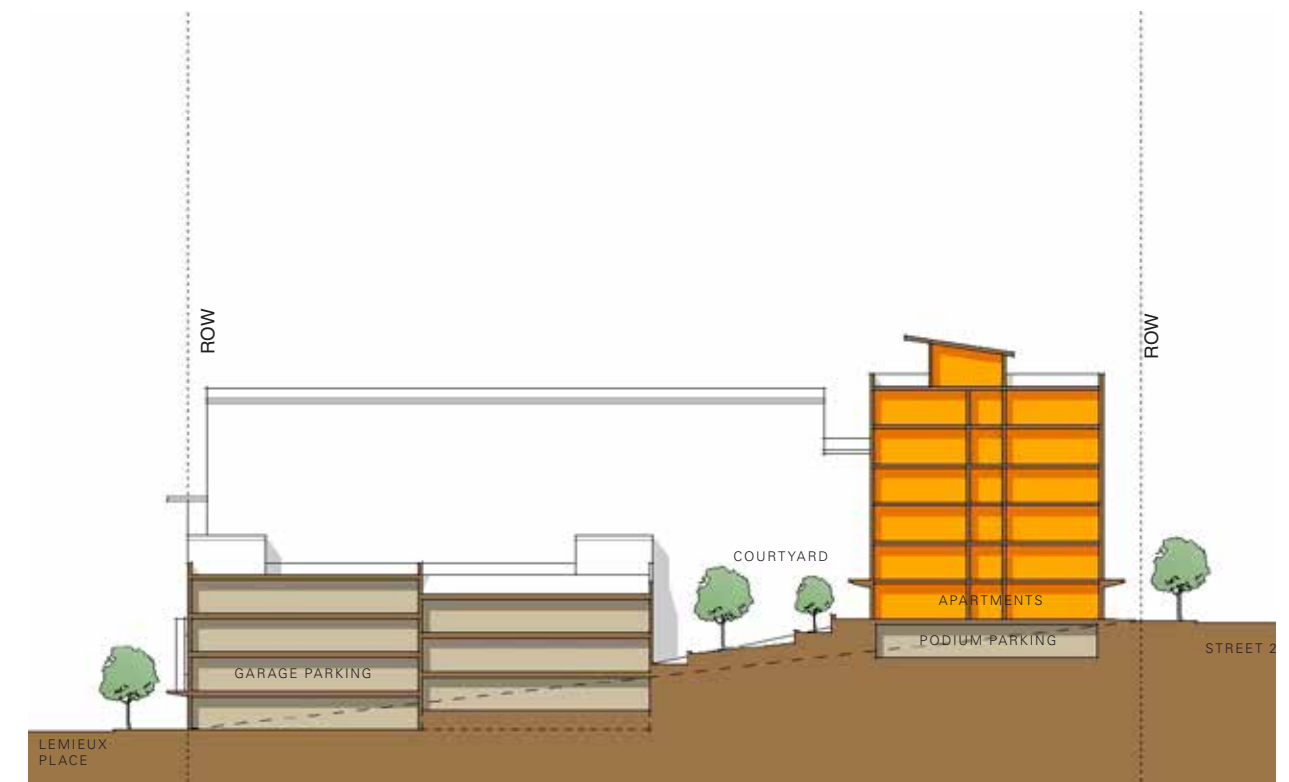

FIGURE 10.29 Block Section



## Sec. 10.7 Illustrative Block F

Block F will become a signature community park designed to accommodate major public gatherings as well as daily users. The park will slope towards Downtown and will feature a new multi-use pavilion located at the convergence of Centre Avenue, Washington Place, and Wylie Avenue. The Civic Open Space will be a major focal point and a dynamic center of activity for the Lower Hill Site Redevelopment, so the overall design must successfully integrate the design of surrounding buildings with the design of the public space. The Illustrative Block Plan illustrates a park that functions as an outdoor amphitheater facing an outdoor stage and video screen at the entertainment pavilion. This combination creates the possibility for outdoor concerts, pre-game events, outdoor seating for viewing games, and other celebrations. Development of entertainment uses around the park will create the energy and excitement that makes this a focal point of the Lower Hill Site Redevelopment.



FIGURE 10.32 Program Model

TABLE 10.30 Block F Potential Program

Retail/Entertainment	73,050 SF
Park	1.2 acres



FIGURE 10.31 Section Locator Plan



FIGURE 10.33 Illustrative Block Plan

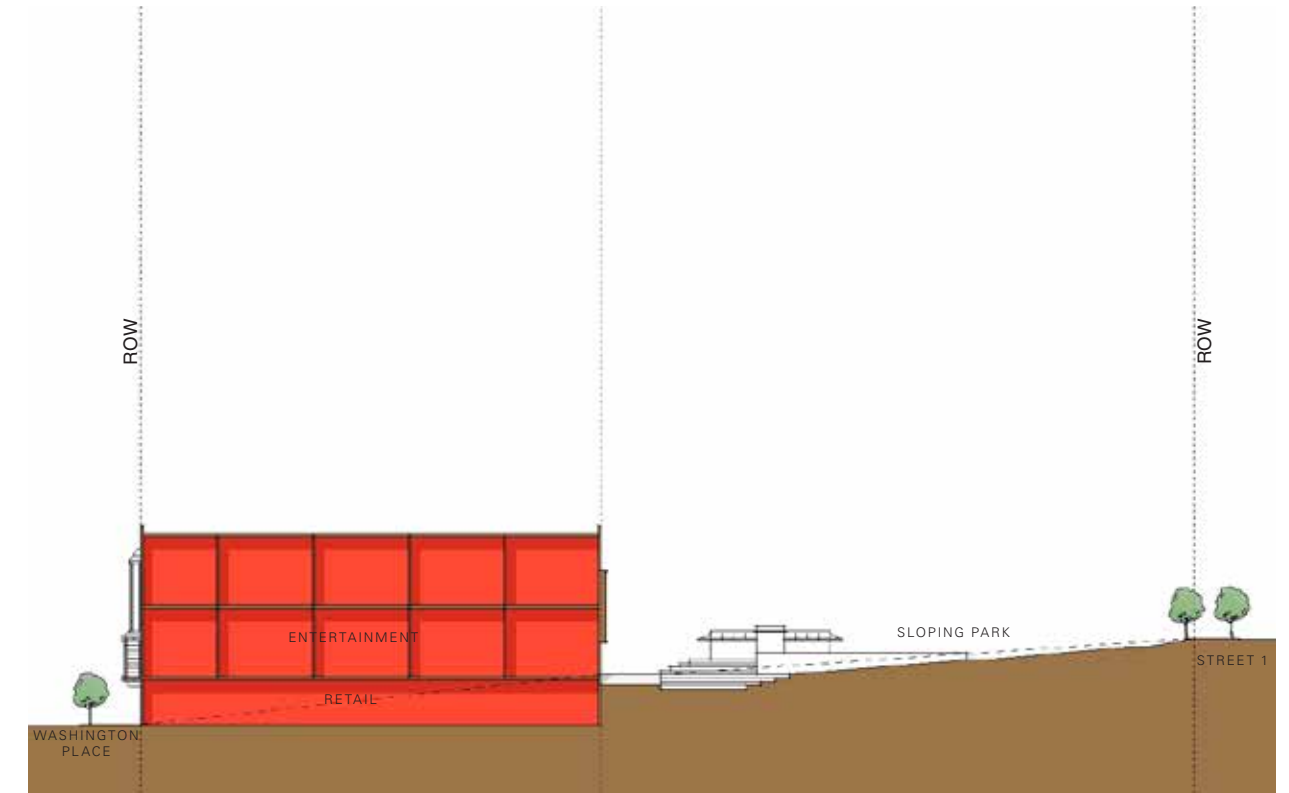

FIGURE 10.34 Block Section



## Sec. 10.8 Illustrative Block G

Block G is a large block that will accommodate substantial mixed-use development. This block is large enough to include a large parking garage, similar to Block E. The availability of a large pool of parking suggests a range of commercial uses that include office space, a hotel, restaurants, retail and other destination uses. The conceptual design illustrates an arrangement of buildings around the perimeter of the block with a parking garage in the center of the block. The garage provides an opportunity to create a large Green Roof. A hotel is shown with views of the signature community park and a porte cochere that leads to the garage. Two office buildings with large floor plates and varying heights are shown. Together, they create a corporate campus with spectacular views of the city, which would be attractive to many corporate tenants. This block is highly visible and accessible, so it should have an active street frontage that responds to its important location in the city.



FIGURE 10.37 Program Model

TABLE 10.35 Block G Potential Program

Hotel (150 Rooms)	99,900 SF
Retail/Commercial	89,836 SF
Office	407,592 SF
Garage Parking	568 cars
Podium Parking	132 cars



FIGURE 10.36 Section Locator Plan



FIGURE 10.38 Illustrative Block Plan

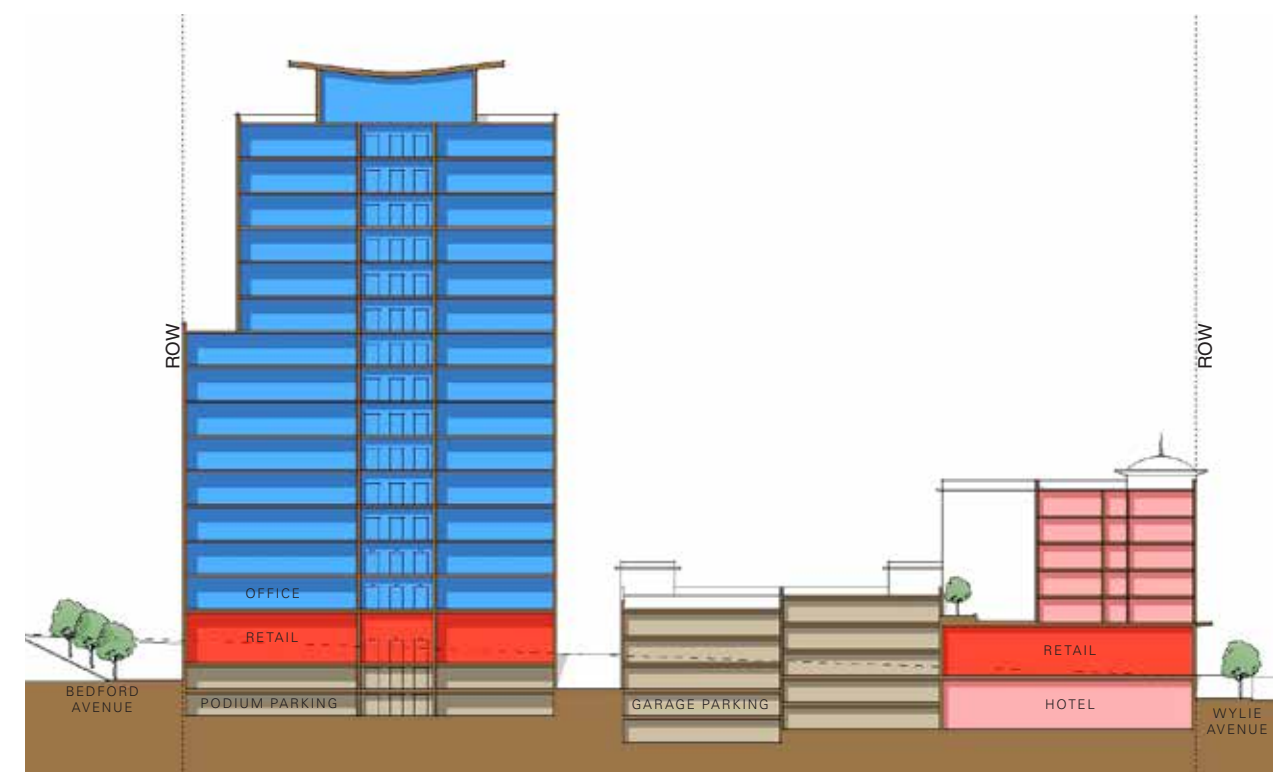

FIGURE 10.39 Block Section



## Sec. 10.9 Illustrative Block H

Many decades ago, a seamless urban fabric connected a vibrant Lower Hill to Downtown. Today, a freeway trench and a tangle of interchanges divide the two neighbors. Along with the historic Fifth Avenue commercial district, CONSOL Energy Center, and Duquesne University, the former arena site is uniquely situated to spur further development in the Downtown area and to grow along with it. The Illustrative Master Plan strengthens the pedestrian connections between Downtown and the Lower Hill to create a cohesive network and to mend the physical divide. A cap over the trench would create a new park between the two districts, erasing the barrier and making a pleasant place out of a concrete canyon. The proposed park design includes terraced lawns, sweeping beds of flowers, and groves of trees to create an urban haven. At the corner of Centre Avenue and Washington, a restaurant with outdoor terrace seating will help activate the park while treating its patrons to an enjoyable park vista. A smaller cafe pavilion is envisioned at the western end of the park.

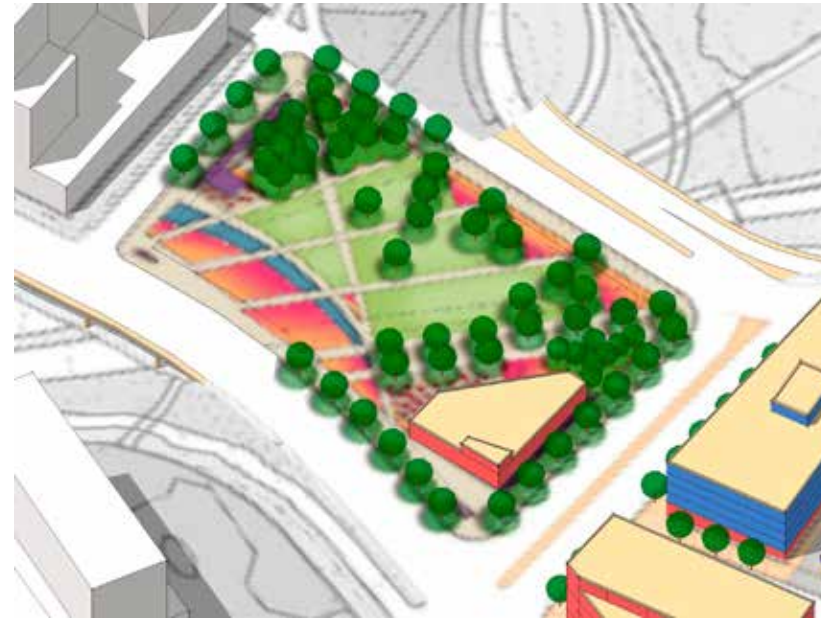

FIGURE 10.42 Program Model

TABLE 10.40 Block H Potential Program

Retail/Commercial	5,000 SF
Park	0.6 acres



FIGURE 10.41 Section Locator Plan



FIGURE 10.43 Illustrative Block Plan

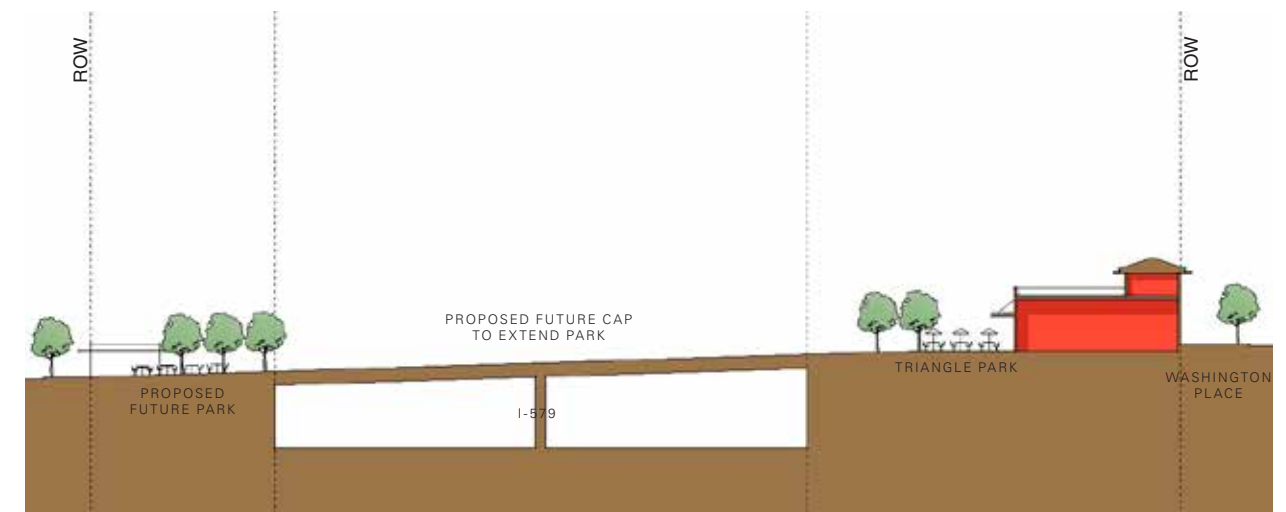

FIGURE 10.44 Block Section



# Sec. 10.10 Multi-User Parking Application

## 10.10.1 Parking Metrics

As described in Section 2.9, a multi-user parking strategy will be needed to make the most of the off-street parking supply within the Lower Hill Site Redevelopment. Except for parking accessory to residential use, parking structures throughout the SP District are intended to be shared by multiple users and not solely as accessory parking to a principle use. The transportation study discussed below describes one parking scenario based on a standard parking approach.

## 10.10.2 Lower Hill Site Redevelopment Master Plan Transportation Study

In connection with this PLDP, Trans Associates prepared and submitted a Lower Hill Site Redevelopment Master Plan Transportation Study, which includes a parking analysis based on the Illustrative Master Plan set forth in Section 9. The Illustrative Master Plan presents potential minimum and maximum development scenarios for the site. The parking analysis is based on a potential maximum development scenario with estimated parking demands derived from standard Pittsburgh Zoning Code requirements (not the SP District Zoning Code provisions discussed in Section 7.4) and applying standard Zoning Code deductions to those estimated parking demands. The chart in Figure 10.47 demonstrates how a potential maximum development scenario would function using a multi-user parking strategy (based on the aforementioned estimated parking demands). This analysis sets the maximum number of off-street parking spaces that the site is able to accommodate at 2,457 (excluding the CONSOL Arena parking garage), which is sufficient to service the potential maximum development scenario in the Illustrative Master Plan. As the site is developed, adjustments to the parking analysis will be required (to the extent the analysis is used in support of a FLDP) to account for, among other things, existing development, the location of existing parking and actual parking demand.

Block	Number of Parking Spaces Provided (Excluding CONSOL Garage)	Development Component	Size <sup>(2)</sup>	Parking Demand: City of Pittsburgh Zoning Code <sup>(1)</sup>					Unassigned Spaces Available for	
				Parking Demand Rate	Total Automobile Parking (Includes Spaces for Persons with Disabilities)	Number of Spaces to be Provided for Persons with Disabilities <sup>(3)</sup>	Potential Multi-Modal Parking Reduction <sup>(4)(5)</sup>	Required Number of Parking Spaces with Maximum Bicycle Parking Reduction <sup>(6)</sup>	Daytime <sup>(8)</sup>	Evening/Weekend Events <sup>(9)</sup>
A OLD A & B	365	Residential	344 units	1 per unit	344	8	101	243	0	0
		Retail	13,390 SF	1 per 500 SF above first 2,400 SF	17	1	5	12		
		<b>Subtotal A</b>	--	--	--	<b>367</b>	<b>9</b>	<b>106</b>		
B OLD D	247	Residential	224 units	1 per unit	224	7	65	159	79	79
		Retail	10,910 SF	1 per 500 SF above first 2,400 SF	13	1	4	9		
		<b>Subtotal B</b>	--	--	--	<b>237</b>	<b>8</b>	<b>69</b>		
C OLD C & E	360	Residential	357 units	1 per unit	357	8	105	252	0	0
D OLD F	305	Residential	142 units	1 per unit	142	5	41	101	66	150
		Retail	42,200 SF	1 per 500 SF above first 2,400 SF	63	3	18	45		
		Office	116,000 SF	1 per 500 SF above first 2,400 SF	181	6	88	93		
		<b>Subtotal D</b>	--	--	--	<b>386</b>	<b>14</b>	<b>147</b>		
E OLD G	480	Residential	125 units	1 per unit	125	5	36	89	210	369
		Retail	14,415 SF	1 per 500 SF above first 2,400 SF	18	1	5	13		
		Office	108,370 SF	1 per 500 SF above first 2,400 SF	169	6	82	87		
		<b>Subtotal E</b>	--	--	--	<b>312</b>	<b>12</b>	<b>123</b>		
F OLD H	0	Retail	24,350 SF	1 per 500 SF above first 2,400 SF	34	2	10	24	0	0
		Cineplex	2,310 seats	1 per 5 seats	462	9	227	235		
		<b>Subtotal F</b>	--	--	--	<b>496</b>	<b>11</b>	<b>237</b>		
G OLD I	700	Retail	89,836 SF	1 per 500 SF above first 2,400 SF	139	5	40	99	0	216
		Office	407,592 SF	1 per 500 SF above first 2,400 SF	647	13	317	330		
		Hotel <sup>(7)</sup>	150 rooms	0.62 spaces per room	93	4	2	91		
		<b>Subtotal G</b>	--	--	--	<b>879</b>	<b>18</b>	<b>359</b>		
H OLD J	0	Retail	5,000 SF	1 per 500 SF above first 2,400 SF	3	1	1	2	0	0
<b>Total</b>	<b>2,457</b>	--	--	--	<b>3,031</b>	<b>81</b>	<b>1,147</b>	<b>1,884</b>	<b>355</b>	<b>814</b>

(1) Based on the City of Pittsburgh Urban Zoning Code, Chapter 914: Parking Loading and Access.  
 (2) Based on section 914.03.C, Calculation of Floor Area, of the City of Pittsburgh Urban Zoning Code, the square footage of floor area utilized in the parking demand calculations is 80% of the total gross floor area for office and retail development components.  
 (3) Based on Section 914.06.A, Number of Spaces for Persons with Disabilities, of the City of Pittsburgh Urban Zoning Code.  
 (4) Based on Section 914.05.E, Off-Street Parking Reduction for Bicycle parking, the reduction in the number of automobile spaces shall be reduced by no more than 30% of the total required spaces, excluding parking spaces for persons with disabilities. In addition, parking reductions for hotel use are to be based upon the number of employees. For this study, it was assumed that the hotel would fall into the category of 21-50 employees, which requires 2 bicycle parking spaces.  
 (5) The multimodal parking reduction for the office and Cineplex uses was assumed to be 50% based on the Pittsburgh Downtown Partnership Travel Mode Survey.  
 (6) The required number of spaces was determined by subtracting the Potential Multi-Modal Parking Reduction from the Total Automobile Parking (including spaces for persons with disabilities).  
 (7) The parking demand rate for the hotel was calculated based on data provided for the Shadyside Courtyard Marriott Hotel and also approved for the One Grandview Center Hotel Study.  
 (8) See Table 2A for details.  
 (9) See Table 2B for details.

Source: Analysis by Trans Associates.

FIGURE 10.45 Parking analysis based on the illustrative plan in the PLDP



# Section 11. Implementation Program

Sec. 11.1 Implementation Program III



SKIBBA/COONT 2012



## Sec. 11.1 Implementation Program

The SP-11 Lower Hill Planned Development District will be developed in accordance with this SP 11 Lower Hill Planned Development District Preliminary Land Development Plan (“PLDP”) and the amendment to the Zoning Ordinance creating and regulating the SP-11 Lower Hill Planned Development District (“SP-11 Zoning Text”). It is anticipated that federal, state, local, corporate, community partners and private developers will be engaged to varying degrees, as such entities may agree, to fully realize the redevelopment. The redevelopment will occur in a manner that follows the requirements of this PLDP. LEED-ND prerequisites and goals shall be considered at each stage of the implementation process. The requirements of the SP-11 Zoning Text, and the requirements, recommendations, goals and objectives set out in this PLDP shall be considered at the submission of each individual Final Land Development Plan (“FLDP”).

### 11.1.1 Supporting Reports

The following supporting reports have been submitted in connection with the SP-11 Zoning Text and this PLDP in accordance with Pittsburgh Zoning Code Section 909.01.B.9 include:

#### A. Socio-economic impact on city and region.

- a. Mellon Arena Site Redevelopment Strategy — Market Analysis. Prepared by AECOM dated February 2010.
- b. Mellon Arena Site Redevelopment Strategy — Economic and Fiscal Impact Analysis. Prepared by AECOM dated February 2010.

#### B. Traffic and parking impact and future potential for increasing capacity.

- a. Trans Associates, Lower Hill Site Redevelopment Master Plan Transportation Study, dated May 31, 2013

#### C. Utility capacity

- a. Preliminary Drainage Design Report for Lower Hill Infrastructure Redevelopment (SFPM). Prepared by Cosmos Engineering dated January 30, 2013 and letter from Mr. Daniel Sentz, City of Pittsburgh Department of City Planning dated March 8, 2013 indicating acceptance of Report.
- b. Letters from utility providers indicating capacity
  - > » i. Duquesne Electric
  - > » ii. Equitable
  - > » iii. Comcast
  - > » iv. Verizon

#### D. Geotechnical, ecological and environmental analysis

- a. Listing of Civic Arena Environmental reports as of October 16, 2012
- b. Phase 1 Environmental Site Assessment for the Lower Hill Redevelopment Project, prepared by Michael Baker Jr, Inc., dated February 2013.
- c. Pre-Final Geotechnical Engineering Report for the Lower Hill Redevelopment Project, prepared by Michael Baker Jr., Inc., dated December 2012.

#### E. Analysis of structure or site of historic, archeological, architectural, recreational, scenic or environmental significance.

- a. Archeological Survey of the Lower Hill Redevelopment Project. Prepared by Michael Baker Jr., Inc., dated June 2013 including Appendices.
- b. Michael Baker, Jr. Inc. transmittal letter to Pennsylvania Historical and Museum Commission dated June 14, 2013.
- c. Letter from Pennsylvania Historical and Museum Commission to Michael Baker Jr., Inc. dated July 3, 2013.

#### F. Analysis of views to and from the site

- a. Analysis of Views to and From the Site, prepared by Urban Design Associates dated July 12, 2013.

#### G. Analysis of visual impact on surrounding area.

- a. Analysis of visual Impact, prepared by Urban Design Associates, dated July 12, 2013.

### 11.1.2 Site Control

The parcels within the boundaries of the SP-11 Lower Hill Planned Development District are owned by the SEA and URA. Property within boundaries of Subdistrict 1 and Subdistrict 2 is controlled by the Penguins pursuant to an Option Agreement with the property owners. The SEA, as owner of the property in Subdistrict 3 joins the Penguins as applicant. In regard to the proposed CAP Project, that is, the creation of a green space spanning 1-579, there exists that certain License Agreement by and among the Commonwealth of Pennsylvania and the URA, as Licensors, and the Pittsburgh Arena Real Estate Redevelopment LP and the SEA as Licensees, dated January 9, 2014 as it may be amended. Except for air rights and other easements that may be required in connection with construction of the CAP Project, there is neither additional land to acquire or vacate. Boundaries of public rights of way shall require minor adjustment through vacation and dedication.

### 11.1.3 Displacement

There are no active businesses or residents that will be displaced as a result of the project with the exception of surface parking operations.

### 11.1.4 Site Preparation

The SEA completed demolition of the Civic Arena in the fall of 2012 and has constructed surface parking and provided temporary erosion and sedimentation controls in the area of the former Civic Arena.

### 11.1.5 Development Program

The PLDP proposes the addition of .81 miles of new streets to be dedicated to the City and the creation of development blocks. containing approximately 22 acres of land. As noted in Section 2.5 of this PLDP, 2.8 acres will be dedicated as Urban Open Space, as required by the Zoning Code. An additional 3.1 acres of Urban Open Space may be added, as part of the CAP Project, if constructed. The CAP green space is not required to satisfy the Zoning Code requirement for 10% Urban Open Space.

An Illustrative Master Plan is included in the PLDP which is based upon the Market Analysis prepared by AECOM in 2010. The Market Analysis is provided as a supporting document to the PLDP and the application for amendment to the Zoning Code to create the SP-11 Lower Hill Planned Development District. The Market Analysis indicates demand in residential, commercial, retail (to include entertainment retail), hospitality and office categories and an evaluation of the site capacity has resulted in a mixed-use development program which could possibly be comprised of:

- » Residential 1, 188 units
- » Retail/Commercial/Entertainment 248,800 square feet
- » Office 632,000 square feet
- » Hotel 150 rooms

### 11.1.6 Infrastructure

Roads and utility infrastructure will be completed in phases based on available funding. It is intended that each phase will be structured in a manner to provide for complete blocks, or groups of blocks within a sub-district. Local private utility providers (Equitable Gas, Duquesne Light, Comcast and Verizon) have submitted letters which are provided as supporting documents to the SP-11 application indicating that sufficient services are available to the site to meet the projected demand of the proposed development program.



A Sewer Facility Planning Module (SFPM) has been prepared and approved by Department of City Planning and the PA Department of Environmental Protection. The SFPM is provided as a supporting document to the SP-11 application. Sufficient stormwater, domestic water and sanitary facilities exist to support the proposed development program. The stormwater management strategies identified in Section 7 will benefit existing stormwater and sanitary system impacts beyond the SP-11 Lower Hill Planned Development District.

#### 11.1.7 Project Budget

Based on the Illustrative Master Plan, the estimated budget for development of infrastructure and Urban Open Space, including the CAP Project is \$71M. The estimated budget for development at the development parcels, is \$440M. Public and private funds will contribute to the development costs.

#### 11.1.8 Development

Each development project will be shared with the public and submitted for approval by the Planning Commission through the Final Land Development Plan (FLDP) process as outlined in City of Pittsburgh's Zoning Code Section 922.11.C. The FLDP application shall be accompanied by a site plan that complies with the requirements of Section 922.01.D.2 of the zoning code. The applicant intends that Section 922.01.D of the zoning code pertains to this PLDP.

#### 11.1.9 Urban Open Space

The City of Pittsburgh's Zoning Code requires that 10% of the gross development area be dedicated Urban Open Space. This Lower Hill PLDP intends that the fulfillment of this requirement will be accomplished through the creation of four Urban Open Spaces, at locations identified in the PLDP and described in this PLDP as "Community Open Space", "Civic Open Space" and "Block H Open Space" and "Block C Urban Open Space" (the Pedestrian Easement). These Urban Open Spaces will be publicly accessible and otherwise meet applicable Urban Open Space requirements of the Zoning Code and will be developed in accordance with Section 2.6. Maintenance of Urban Open Space will be provided through the filing of a legally binding agreement as required in section 909.01.D.3.C)(3). In order to obtain the benefit of aggregating the Urban Open Space requirement into the four spaces depicted in this PLDP, the schedule set forth in Section 2.6 shall be followed.

#### 11.1.10 Environmental Consequences

No adverse environmental consequences are anticipated. It is a stated goal of this PLDP that the SP-11 Lower Hill Planned Development District be developed to achieve a LEED-ND rating and that each development project will demonstrate an effort to achieve relevant LEED standards. This PLDP proposes increased vegetation and improved management of stormwater. Dependence on automobiles will also be reduced by creating density in residential uses and incorporating other mixed uses in an urban location. Initiatives such as District Energy facilities in the immediate vicinity of the SP-11 Lower Hill Planned Development District can promote environmentally friendly solutions in the district.

#### 11.1.11 Social and Economic Consequences

Fiscal and Economic impacts were estimated based on the development program prepared by AECOM in 2010. The Economic Impact Analysis is provided as a supporting document to the SPD-11 application and the applicant of each FLDP will report the projected outcome of the development in regard to jobs and tax generation. The following economic impacts excluding indirect jobs were identified in the AECOM report.

- » CONSTRUCTION PERIOD
  - › Jobs 4,312
  - › Total Payroll \$160,772,005
  - › Annual Taxes:
  - › City \$1,104,250
  - › School N/A
  - › County \$2,143,627
  - › State \$17,797,461
- » PERMANENT OPERATING PERIOD
  - › Jobs 2,948
  - › Annual Payroll \$145,924,814
  - › Annual Taxes:
  - › City \$7,886,654
  - › School \$7,800,927
  - › County \$2,416,249
  - › State \$7,023,629

Over the past several years the Penguins, public leaders and community representatives have been meeting to discuss ways in which the Lower Hill Redevelopment can be leveraged to this end. The outcome of these discussions is a Community Collaboration and Implementation Plan (CCIP) that provides a framework for positive impacts through the collaborative participation of the project sponsors, developers, service providers, local corporations, foundations and the immediate community. The CCIP identifies focus areas of Minority and Women Business Enterprise inclusion, homeownership and affordability, wealth building initiatives, workforce development and jobs as well as a process for celebrating the legacy and history of the site and coordinating community development. The CCIP is intended to work in parallel with the Preliminary Land Development Plan and to be implemented over the course of the redevelopment.

#### 11.1.12 Public Art Plan Reporting Requirement

Each FLDP shall include a statement regarding the inclusion of publicly available art that addresses the Development Guidelines of Section 7.3. Such art may be included on-site or off-site as part of a wider strategy for providing art in the SP-11 Lower Hill Planned Development District, provided that the location and placement of such art allows for it to be experienced by the general public. Submission of art plans located on private development parcels or within urban open space shall not require Art Commission approval.



# Section 12. Definitions

Sec. 12.1 Definitions 113





## Sec. 12.1 Definitions

As a general rule, all terms used in the PLDP that are not otherwise defined below have the meanings set forth in the Pittsburgh Zoning Ordinance.

### Alley

means a right-of-way (public or private) that provides vehicle parking, service and/or pedestrian connection functions, but which does not meet the requirements of any Street Type.

### Americans with Disabilities Act (ADA)

means the federal law known as the Americans with Disabilities Act of 1990 together with the ADA Standards for Accessible Design.

### Articulate

means emphasizing an architectural feature or a building element by distinguishing such feature or element from other parts of a structure. Sometimes also referred to as “articulation.”

### Back-lighting

means the placement of light behind or at right angles to an object to produce such effects as depth or separation of subject and background.

### Bay

means the distance between horizontal or vertical structural components of a building.

### Bay Window

means a window that protrudes from the facade of a building.

### Block

means an area of land bounded by streets and intended for development. A block may contain several buildings and/or open space and can be subdivided into smaller parcels.

### Blue Roof

means a non-vegetative roof that incorporates systems for the temporary storage and incremental release and/or reuse of stormwater.

### Building Depth

means length of main body of building more or less perpendicular to the right of way from the street facing facade to its rear wall.

### Building Height

has the meaning set forth in Section 925.07.A of the Zoning Ordinance.

### Building Type

means a classification of a building based on form, including building width and height.

### CAP Open Space

means the CAP Project.

### CAP Project

means the pedestrian connection with landscaping and open space amenities to be constructed over the Crosstown Expressway that connects Block H to Downtown.

### CCIP

means the Community Collaboration and Implementation Plan.

### Civic Arena

means the arena formerly located on the Lower Hill Redevelopment Site and demolished in 2010.

### Color Rendering Index

means a measure of a light source’s ability to show object colors realistically or naturally compared to a familiar reference source, either incandescent light or daylight.

### Commercial Streetfront

means the ground level facade of a building facing a street that is dedicated to commercial use.

### Commercial Use

means any non-residential use such as retail, restaurant, or office.

### Community Collaboration and Implementation Plan

means the document between the Penguins and community groups providing a framework for collaborative participation in development of the Site.

**Cornice** means a protrusion from the top of a ceiling or pediment, or at the bottom of a roof.

**Curtain Call Project** means the pedestrian connection on the site of CONSOL Arena that connects Centre Avenue and Fifth Avenue and includes a series of rain gardens surrounded by vertical frames that will display images collected through a process of engaging the local community.

### Dark Sky

means the portion of sky where the darkness of the night sky is relatively free of interference from artificial light.

### DCP

means the Department of City Planning.

### Development Guidelines

means the portions of this PLDP that are not required for FLDP approval, but which are encouraged to be incorporated into an FLDP.

### Element

means an architectural component of a building facade.

### Frontage Type

means a classification of a building facade based on the form of the Street Frontage outlined in Section 2.7.

### Green Roof

means a roof that is partially or completely covered with vegetation, planted over a waterproofing membrane. It may also include additional layers such as a root barrier and drainage and irrigation systems.

### Human Scale

means the relationship of a built environment to human proportion

### Illustrative Master Plan

means the plan incorporated into the PLDP as Section 10, which is intended to illustrate the development possibilities for the Lower Hill Redevelopment Site and the CAP using the Regulating Plans and the Design Recommendations.

### Integral Parking

means parking areas located underneath a building that are associated with a residential units in such building and having an individual garage door (commonly referred to as ‘tuck under’).

### LED

means an efficient source of light referred to as a light emitting diode used for lighting and digital display.

### LEED

means Leadership in Energy and Environmental Design standards established by the United States Green Building Council.



**LEED for Neighborhood Development**

means a rating system establishing development standards adopted by the United States Green Building Council for multi-site development.

**LEED Planning Submission**

has the meaning set forth in Section 2.3 of the PLDP.

**LEED-ND**

means LEED for Neighborhood Development

**Linear Building**

means a building that lines another building or structure. For example, a building that lines a parking garage.

**Lot**

means a parcel or combination of adjacent parcels.

**Lower Hill Preliminary Land Development Plan**

means the Preliminary Land Development Plan prepared by Urban Design Associates and approved by the Planning Commission.

**Lower Hill Redevelopment Site**

means the land area of Sub Districts 1 and 2.

**Major Public Destination Facility Plaza**

means an area of land containing at least one (1) acre designated as urban open space and located adjacent to and/or across a public street from a Major Public Destination Facility.

**Massing**

means the general shape and size of a building or structure.

**Multi-user Parking**

means a parking garage open to the public, or if designated in part for use as accessory parking for a principal use, also provides parking for other uses.

**Open Space**

means an area of land open to the air such as a forecourt or courtyard, but not including a street.

**Parcel**

means an area of land legally subdivided from a Block.

**Parking Garage**

means a parking structure that is not Podium Parking or Integral Parking.

**Pedestrian Connection or Pedestrian Passageway or Pedestrian Easement**

means an easement, right-of-way or license that provides access through a block or parcel, in accordance with this PLDP and as further required by the terms of Section 2.5, that is designated for pedestrian use.

**Permitted Parking Types**

means a classification of a parking area based on the form of parking outlined in Section 2.9.

**Pittsburgh 2030 District**

means the public-private-nonprofit collaborative that establishes sustainability goals for certain Pittsburgh neighborhoods.

**Planning and Design Goals**

means the goals set forth in Section 1.3.1 of the PLDP.

**PLDP**

means the Lower Hill Preliminary Land Development Plan.

**Podium Parking**

means a parking area situated under a building and serving as the base of the building.

**Primary Frontage**

means a classification of a Street Frontage based on the depiction set forth in Section 2.7 and along which at least one primary entrance to a building is located.

**Private**

means controlled by an individual or entity that is not a government entity or instrumentality.

**Public**

means generally accessible to the public.

**Regulating Plans**

means portions of this PLDP that contain required standards for development that must be satisfied for PLDP approval.

**Required Easement**

means the Pedestrian Connection to be created and located at a required location, that is, the connection between Bedford Avenue and Street 2 aligned with Webster Avenue. . The Required Easement is also known as the Block C Urban Open Space.

**Right-of-Way**

means (1) an area of land designated for public or private vehicular and/or pedestrian passage; (2) an area of land designated for utility access.

**ROW**

means a Right-of-Way.

**Secondary Frontage**

means all Street Frontages not classified as a Primary Frontage.

**Site**

means the Lower Hill Redevelopment Site.

**SP District**

means the SP-11 Lower Hill Specially Planned District

**SP-11 Lower Hill Planned Development District**

means the area depicted in figure 2.2 of the PLDP.

**SP-11 Zoning Text**

means the zoning amendment and ordinance adopted by the Pittsburgh City Council in connection with the creation of the SP-11 Lower Hill Specially Planned Development District.

**Standalone Building**

means a building that is not a liner building.

**Stormwater Ordinance**

means Section 1003 of the Zoning Ordinance.

**Street**

means a right-of-way depicted in Section 3 of the PLDP.

**Street Frontage**

means a building façade facing a street or alley.



**Street Type**

means a classification of a street based on dimension, design and intended traffic volume.

**Traffic and Parking Report**

means a report submitted in connection with an FLDP addressing traffic generation and parking needs of a proposed development. A Traffic and Parking Report is required to contain the elements listed in Section 2.9.1.

**Transparency**

means a glass area unobstructed by signage, interior graphic elements, reflective coating, translucent or textured finish, racking or any type of fixed vertical building elements (such as a wall) within five feet behind such glass area that can be seen from both the interior and exterior of the building.

**Tree Pittsburgh**

means the environmental non-profit organization dedicated to enhancing the City's vitality by restoring and protecting City trees.

**U.S. Green Building Council**

means the non-profit corporation organized under the laws of the District of Columbia that focuses on sustainable development and which establishes LEED ND standards.

**Upper Story**

means a story of a building above ground level.

**Urban Forest Master Plan**

means the plan prepared by Tree Pittsburgh and published in 2012.

**Urban Open Space**

has the meaning set forth in Section 909 of the Zoning Ordinance.

**Zoning Ordinance**

means the Zoning Code of the City of Pittsburgh.